

*RoHS COMPLIANT



BOURNS®

Features

- 6 mm Round / Single-Turn / Cermet Industrial / Open Frame
- Cross slot adjustment options
- Horizontal and vertical mounting styles
- Dust resistant/splash resistant covers
- PC board stand-offs and retention feature
- Front and top adjust styles
- RoHS compliant*

3306 - 6 mm Round Trimming Potentiometer

Electrical Characteristics

Standard Resistance Range100 ohms to 1 megohm (see standard resistance table)
 Resistance Tolerance±25 % std. (tighter tolerance available)
 Absolute Minimum Resistance2 % max. (≤2K = 30 ohms)
 Contact Resistance Variation .3 % max.
 Resolution.....Essentially infinite
 Adjustment Angle215 ° nom.

Environmental Characteristics

Power Rating (100 volts max.)
 70 °C0.2 watt
 Temperature Range-25 °C to +100 °C
 Temperature Coefficient±250 ppm/°C
 Load Life ...1,000 hours 0.2 watt @ 70 °C (5 % ΔTR)

Physical Characteristics

Mechanical Angle.....260 ° ±20 °
 Torque (Operating).....4.5 oz-in. max.
 Stop Strength.....6.5 oz -in. min.
 TerminalsSolderable pins
 MarkingManufacturer's trademark, resistance code
 Standard Packaging300 pcs. per bag
 Adjustment ToolH-90
 Aqueous cleaning not recommended

How To Order

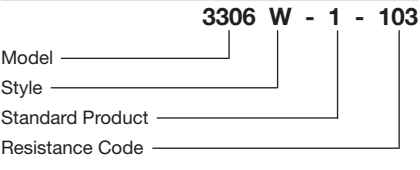

Standard Resistance Table

Resistance (Ohms)	Resistance Code
100	101
200	201
500	501
1,000	102
2,000	202
5,000	502
10,000	103
20,000	203
25,000	253
50,000	503
100,000	104
200,000	204
250,000	254
500,000	504
1,000,000	105

Popular distribution resistance values listed in boldface.

Top Adjust Common Dimensions

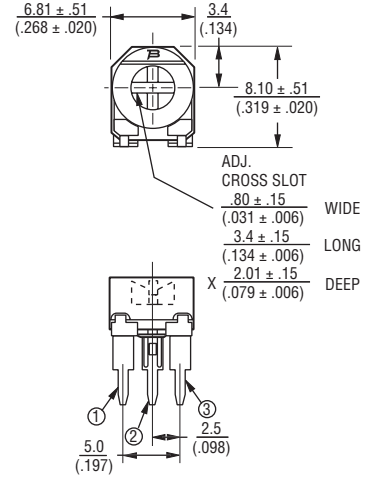

3306P

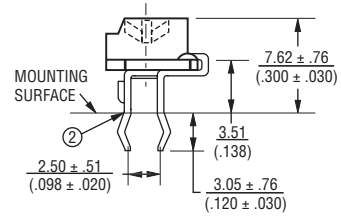

3306F

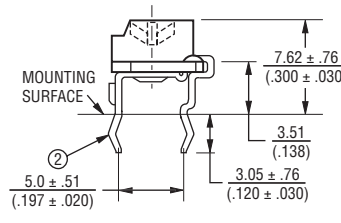

SUGGESTED PWB LAYOUT - STYLE F

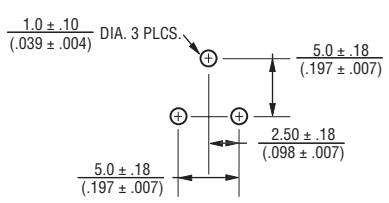

Side Adjust Common Dimensions

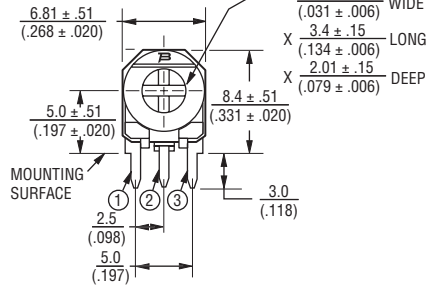

3306W

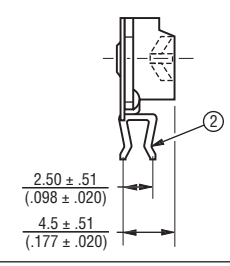

3306K

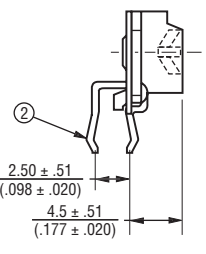

SUGGESTED PWB LAYOUT - STYLES K, P, W

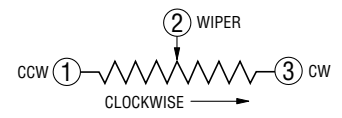
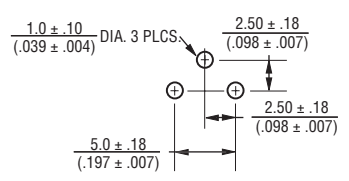

TOLERANCES: ± 0.25 (.010) EXCEPT WHERE NOTED

DIMENSIONS ARE: $\frac{MM}{(INCHES)}$

*RoHS Directive 2002/95/EC Jan 27 2003 including Annex. Specifications are subject to change without notice. Customers should verify actual device performance in their specific applications.