

2SC5758

Silicon NPN Epitaxial
VHF / UHF Wide band amplifier

HITACHI

ADE-208-1397D(Z)

Rev.4
Jul. 2001

Features

- Super compact package: MFPAK (1.4 x 0.8 x 0.59 mm)

Outline

MFPAK

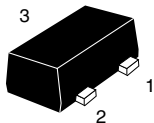

1. Emitter
2. Base
3. Collector

Note: Marking is "WF-".

Absolute Maximum Ratings

(Ta = 25°C)

Item	Symbol	Ratings	Unit
Collector to base voltage	V _{CBO}	10	V
Collector to emitter voltage	V _{CEO}	3.5	V
Emitter to base voltage	V _{EBO}	1.5	V
Collector current	I _C	80	mA
Collector power dissipation	P _C	80	mW
Junction temperature	T _J	150	°C
Storage temperature	T _{stg}	-50 to +150	°C

Electrical Characteristics

(Ta = 25°C)

Item	Symbol	Min	Typ	Max	Unit	Test conditions
Collector to base breakdown voltage	V _{(BR)CBO}	10	—	—	V	I _C = 10 μA, I _E = 0
Collector cutoff current	I _{CBO}	—	—	600	nA	V _{CB} = 10 V, I _E = 0
Collector cutoff current	I _{CEO}	—	—	200	nA	V _{CE} = 3.5 V, R _{BE} = Infinite
Emitter cutoff current	I _{EBO}	—	—	100	nA	V _{EB} = 1.5 V, I _C = 0
DC current transfer ratio	h _{FE}	80	100	130	V	V _{CB} = 1 V, I _C = 5 mA
Collector output capacitance	C _{ob}	0.65	0.95	1.25	pF	V _{CB} = 1 V, I _E = 0, f = 1 MHz
Gain bandwidth product	f _T	6	8	—	GHz	V _{CE} = 1 V, I _C = 5 mA
Power gain	PG	10	13	—	dB	V _{CE} = 1 V, I _C = 5 mA, f = 900 MHz
Noise figure	NF	—	1.0	2.0	dB	V _{CE} = 1 V, I _C = 5 mA, f = 900 MHz

Collector Power Dissipation Curve

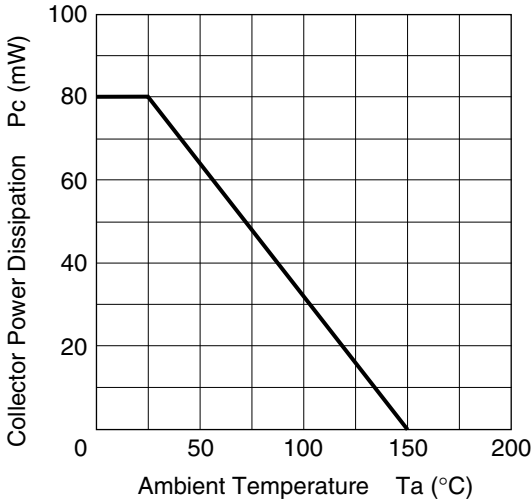

Typical Output Characteristics

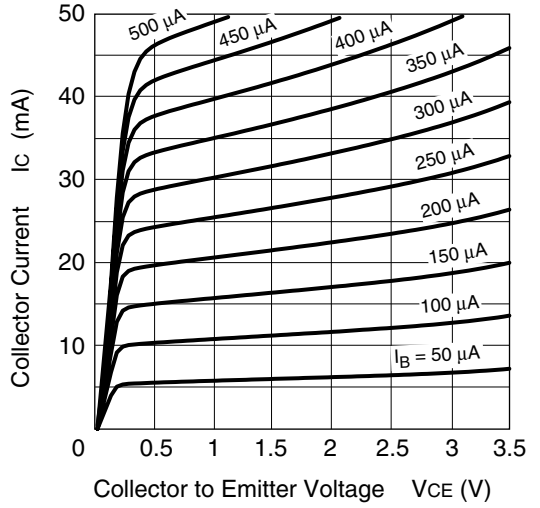

Typical Transfer Characteristics

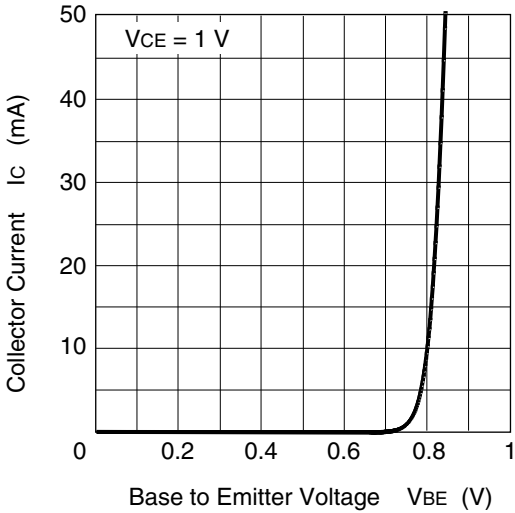

DC Current Transfer Ratio vs. Collector Current

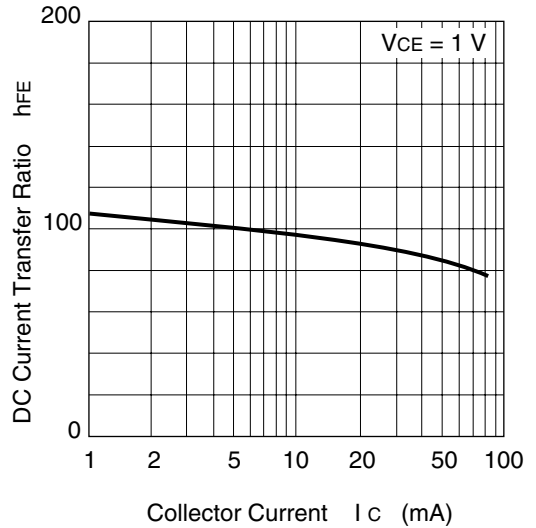

Collector Output Capacitance vs. Collector to Base Voltage

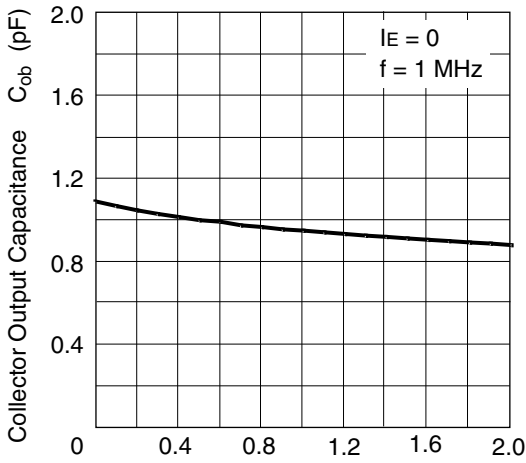

Collector to Base Voltage V_{CB} (V)

Gain Bandwidth Product vs. Collector Current

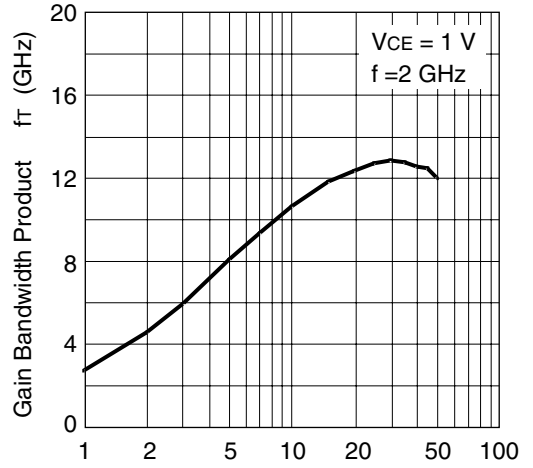

Collector Current I_c (mA)

S_{21} Parameter vs. Collector Current

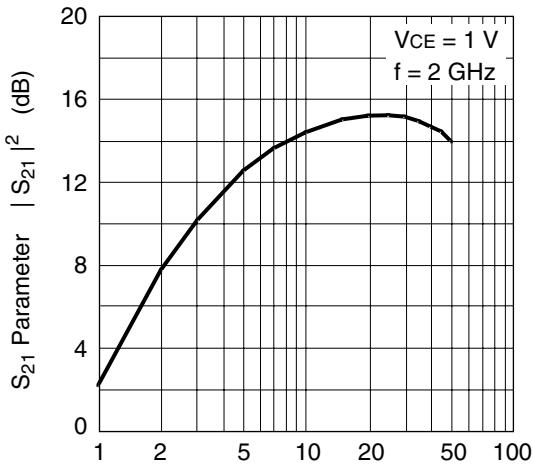

Collector Current I_c (mA)

Power Gain vs. Collector Current

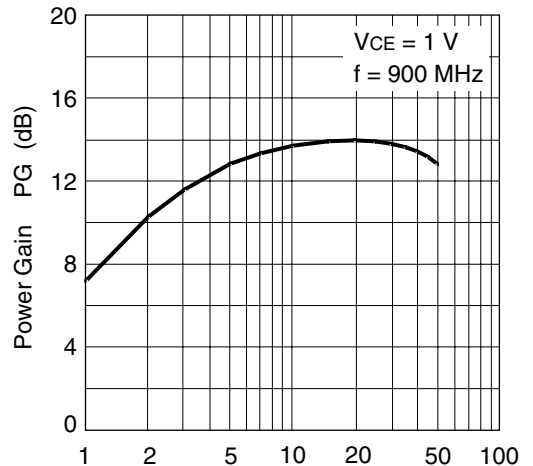

Collector Current I_c (mA)

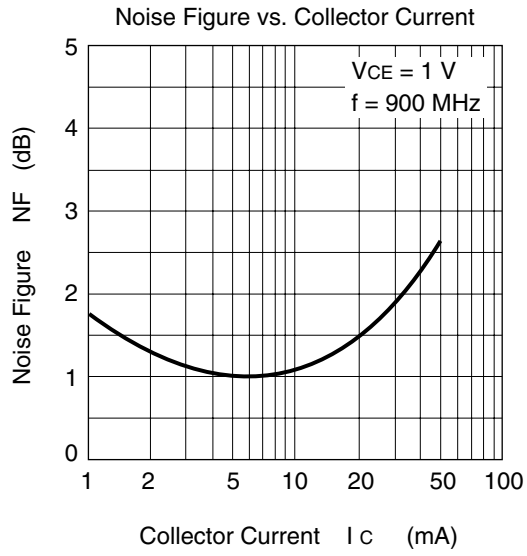

S₁₁ Parameter vs. Frequency

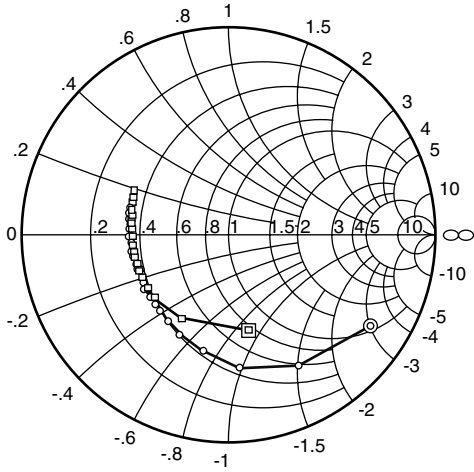

Condition: V_{CE} = 1 V , Z_O = 50 Ω
 100 to 2000 MHz (100 MHz Step)
 ○—○ (I_C = 5 mA)
 □—□ (I_C = 20 mA)

S₂₁ Parameter vs. Frequency

Scale: 8 / div.

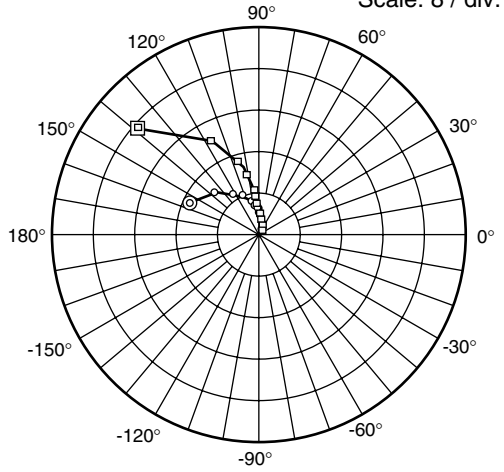

Condition: V_{CE} = 1 V , Z_O = 50 Ω
 100 to 2000 MHz (100 MHz Step)
 ○—○ (I_C = 5 mA)
 □—□ (I_C = 20 mA)

S₁₂ Parameter vs. Frequency

Scale: 0.06 / div.

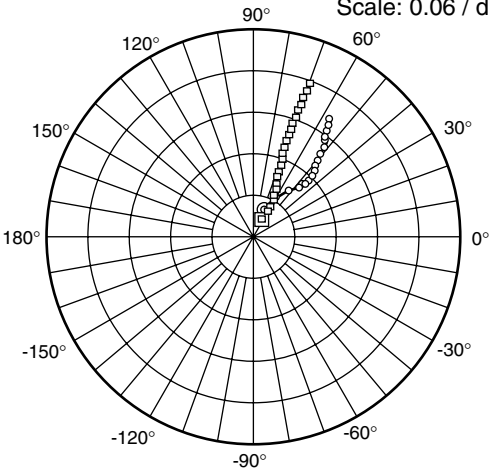

Condition: V_{CE} = 1 V , Z_O = 50 Ω
 100 to 2000 MHz (100 MHz Step)
 ○—○ (I_C = 5 mA)
 □—□ (I_C = 20 mA)

S₂₂ Parameter vs. Frequency

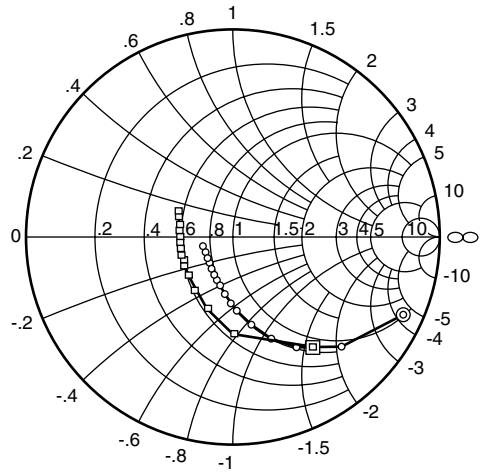

Condition: V_{CE} = 1 V , Z_O = 50 Ω
 100 to 2000 MHz (100 MHz Step)
 ○—○ (I_C = 5 mA)
 □—□ (I_C = 20 mA)

S Parameter $(V_{CE} = 1 \text{ V}, I_C = 5 \text{ mA}, Z_o = 50 \Omega)$

f(MHz)	S11		S21		S12		S22	
	MAG	ANG	MAG	ANG	MAG	ANG	MAG	ANG
100	0.806	-31.9	14.60	157.6	0.038	72.8	0.901	-24.3
200	0.713	-61.5	12.31	138.9	0.067	59.5	0.757	-44.8
300	0.635	-85.3	10.02	125.3	0.085	51.3	0.610	-60.1
400	0.560	-102.7	8.22	115.4	0.096	47.2	0.501	-70.9
500	0.529	-117.1	6.94	108.4	0.104	45.5	0.421	-79.8
600	0.500	-127.8	5.97	103.1	0.111	44.6	0.360	-87.2
700	0.486	-137.2	5.20	98.6	0.117	44.8	0.314	-93.1
800	0.474	-144.1	4.65	94.6	0.123	45.7	0.278	-99.7
900	0.467	-151.1	4.14	91.7	0.129	46.7	0.249	-105.1
1000	0.466	-157.1	3.77	88.4	0.135	47.7	0.226	-110.9
1100	0.461	-162.4	3.45	85.9	0.141	48.6	0.208	-116.0
1200	0.464	-166.1	3.19	83.4	0.147	49.7	0.194	-121.4
1300	0.464	-169.9	2.99	81.3	0.153	51.0	0.181	-127.1
1400	0.467	-173.8	2.78	79.1	0.159	51.8	0.172	-131.7
1500	0.465	-177.2	2.62	77.3	0.166	53.0	0.165	-137.5
1600	0.476	179.9	2.46	75.2	0.174	53.8	0.159	-141.6
1700	0.480	177.4	2.36	73.4	0.180	54.7	0.155	-147.4
1800	0.480	173.4	2.24	71.8	0.187	55.6	0.154	-152.9
1900	0.490	172.0	2.14	70.2	0.195	56.5	0.154	-157.6
2000	0.487	169.3	2.06	68.6	0.202	57.0	0.153	-162.5

2SC5758

($V_{CE} = 1 \text{ V}$, $I_C = 20 \text{ mA}$, $Z_o = 50 \Omega$)

f(MHz)	S11		S21		S12		S22	
	MAG	ANG	MAG	ANG	MAG	ANG	MAG	ANG
100	0.487	-78.2	31.25	138.4	0.026	64.0	0.679	-53.9
200	0.466	-120.9	20.22	117.0	0.040	57.9	0.469	-87.5
300	0.465	-141.6	14.16	106.4	0.050	58.9	0.362	-109.1
400	0.459	-154.5	10.81	100.4	0.060	61.5	0.311	-124.4
500	0.461	-161.8	8.74	96.1	0.070	63.7	0.283	-135.8
600	0.462	-168.1	7.34	92.9	0.080	65.8	0.268	-145.4
700	0.468	-172.8	6.30	90.2	0.091	67.1	0.258	-153.2
800	0.468	-176.5	5.56	87.7	0.101	68.3	0.253	-159.6
900	0.474	179.1	4.93	85.7	0.113	69.0	0.249	-165.5
1000	0.473	176.8	4.46	83.7	0.124	69.5	0.249	-170.7
1100	0.478	173.5	4.07	82.2	0.135	69.8	0.249	-175.1
1200	0.486	170.7	3.75	80.3	0.145	70.2	0.251	-179.3
1300	0.477	168.8	3.51	78.8	0.156	70.2	0.251	176.9
1400	0.493	166.3	3.26	77.2	0.167	70.1	0.254	173.5
1500	0.493	163.6	3.07	75.9	0.179	70.4	0.256	170.4
1600	0.502	161.7	2.88	74.5	0.189	70.4	0.260	167.6
1700	0.506	160.8	2.74	73.2	0.201	70.2	0.263	164.8
1800	0.511	157.7	2.62	72.0	0.211	69.8	0.268	162.1
1900	0.517	156.4	2.49	70.7	0.222	69.9	0.275	159.6
2000	0.523	154.5	2.40	69.5	0.232	69.4	0.280	157.1

Package Dimensions

As of January, 2001
Unit: mm

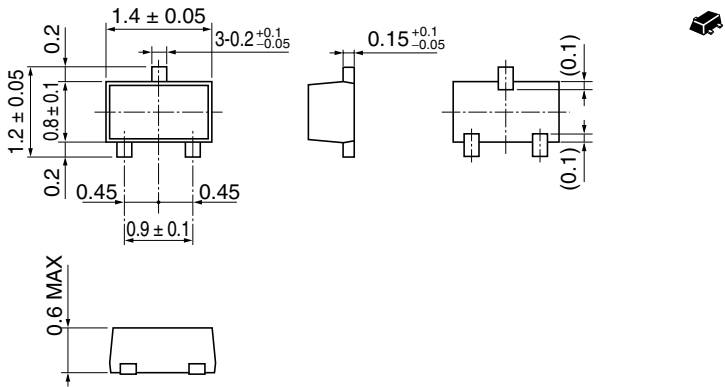

Hitachi Code	MFPAK
JEDEC	—
EIAJ	—
Mass (reference value)	0.0016 g

Disclaimer

1. Hitachi neither warrants nor grants licenses of any rights of Hitachi's or any third party's patent, copyright, trademark, or other intellectual property rights for information contained in this document. Hitachi bears no responsibility for problems that may arise with third party's rights, including intellectual property rights, in connection with use of the information contained in this document.
2. Products and product specifications may be subject to change without notice. Confirm that you have received the latest product standards or specifications before final design, purchase or use.
3. Hitachi makes every attempt to ensure that its products are of high quality and reliability. However, contact Hitachi's sales office before using the product in an application that demands especially high quality and reliability or where its failure or malfunction may directly threaten human life or cause risk of bodily injury, such as aerospace, aeronautics, nuclear power, combustion control, transportation, traffic, safety equipment or medical equipment for life support.
4. Design your application so that the product is used within the ranges guaranteed by Hitachi particularly for maximum rating, operating supply voltage range, heat radiation characteristics, installation conditions and other characteristics. Hitachi bears no responsibility for failure or damage when used beyond the guaranteed ranges. Even within the guaranteed ranges, consider normally foreseeable failure rates or failure modes in semiconductor devices and employ systemic measures such as fail-safes, so that the equipment incorporating Hitachi product does not cause bodily injury, fire or other consequential damage due to operation of the Hitachi product.
5. This product is not designed to be radiation resistant.
6. No one is permitted to reproduce or duplicate, in any form, the whole or part of this document without written approval from Hitachi.
7. Contact Hitachi's sales office for any questions regarding this document or Hitachi semiconductor products.

Sales Offices**HITACHI****Hitachi, Ltd.**

Semiconductor & Integrated Circuits
Nippon Bldg., 2-6-2, Ohte-machi, Chiyoda-ku, Tokyo 100-0004, Japan
Tel: (03) 3270-2111 Fax: (03) 3270-5109

URL North America : <http://semiconductor.hitachi.com/>
 Europe : <http://www.hitachi-eu.com/hel/ecg>
 Asia : <http://sicapac.hitachi-asia.com>
 Japan : <http://www.hitachi.co.jp/Sicd/indx.htm>

For further information write to:

Hitachi Semiconductor (America) Inc.
179 East Tasman Drive
San Jose, CA 95134
Tel: <1> (408) 433-1990
Fax: <1>(408) 433-0223

Hitachi Europe Ltd.
Electronic Components Group
Whitebrook Park
Lower Cookham Road
Maidenhead
Berkshire SL6 8YA, United Kingdom
Tel: <44> (1628) 585000
Fax: <44> (1628) 585200

Hitachi Europe GmbH
Electronic Components Group
Dornacher Straße 3
D-85622 Feldkirchen, Munich
Germany
Tel: <49> (89) 9 9180-0
Fax: <49> (89) 9 29 30 00

Hitachi Asia Ltd.
Hitachi Tower
16 Collyer Quay #20-00
Singapore 049318
Tel : <65>-538-6533/538-8577
Fax : <65>-538-6933/538-3877
URL : <http://www.hitachi.com.sg>

Hitachi Asia Ltd.
(Taipei Branch Office)
4/F, No. 167, Tun Hwa North Road
Hung-Kuo Building
Taipei (105), Taiwan
Tel : <886>-(2)-2718-3666
Fax : <886>-(2)-2718-8180
Telex : 23222 HAS-TP
URL : <http://www.hitachi.com.tw>

Hitachi Asia (Hong Kong) Ltd.
Group III (Electronic Components)
7/F., North Tower
World Finance Centre,
Harbour City, Canton Road
Tsim Sha Tsui, Kowloon
Hong Kong
Tel : <852>-(2)-735-9218
Fax : <852>-(2)-730-0281
URL : <http://semiconductor.hitachi.com.hk>

Copyright © Hitachi, Ltd., 2001. All rights reserved. Printed in Japan.
Colophon 4.0

This datasheet has been download from:

www.datasheetcatalog.com

Datasheets for electronics components.