

2 A HIGH-SPEED SWITCHING SCR

The 2S2M and 2S4M are P-gate fully diffused mold SCRs with an average on-current of 2 A. The repeat peak off-voltages (and reverse voltages) are 200 V and 400 V.

FEATURES

- This transistor is designed for high-speed switching and is ideal for use in commercial frequencies, high-frequency pulse applications, and inverter applications.
- This transistor features a small and lightweight package and is easy to handle even on the mounting surface due to its TO-202AA dimensions. Processing of lead wires and heatsink (tablet) using jigs is also possible.
- Employs flame-retardant epoxy resin (UL94V-0).

APPLICATIONS

Consumer electronic equipments, ignitors of devices for light industry, inverter, and solenoid valve drives

PACKAGE DRAWING (UNIT: mm)

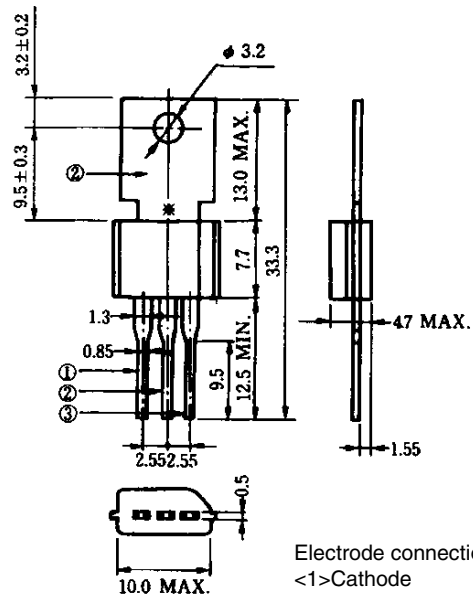

Electrode connection
 <1>Cathode
 <2>Anode
 <3>Gate
 Standard weight: 1.4

*TC test bench-mark

ABSOLUTE MAXIMUM RATINGS (Ta = 25°C)

Parameter	Symbol	2S2M	2S4M	Ratings	Unit
Non-repetitive peak reverse voltage	V_{RSM}	300	500	V	$R_{GK} = 1 \text{ k}\Omega$
Non-repetitive peak off-state voltage	V_{DSM}	300	500	V	$R_{GK} = 1 \text{ k}\Omega$
Repetitive peak reverse voltage	V_{RRM}	200	400	V	$R_{GK} = 1 \text{ k}\Omega$
Repetitive peak off-voltage	V_{DRM}	200	400	V	$R_{GK} = 1 \text{ k}\Omega$
Average on-state current	$I_{T(AV)}$	2 (Tc = 77°C, Single half-wave, $\theta = 180^\circ$)		A	Refer to Figure 6 and 7.
Surge on-state current	I_{TSM}	20 (f = 50 Hz, Sine half-wave, 1 cycle)		A	Refer to Figure 2.
High-frequency peak on-state current	I_{TRM}	15 (Tc = 65°C, f = 10 kp.p.s, $t_p = 10 \mu\text{s}$)		A	—
Fusing current	$\int i^2 dt$	1.6 (1 ms ≤ t ≤ 10 ms)		A ² s	—
Critical rate of rise of on-state current	di_T/dt	50		A/ μs	—
Peak gate power dissipation	P_{GM}	0.5 (f ≥ 50 Hz, Duty ≤ 10%)		W	—
Average gate power dissipation	$P_{G(AV)}$	0.1		W	—
Peak gate forward current	I_{FGM}	0.2 (f ≥ 50 Hz, Duty ≤ 10%)		A	—
Peak gate reverse voltage	V_{RGM}	6		V	—
Junction temperature	T_j	-40 to +125		°C	—
Storage temperature	T_{stg}	-55 to +150		°C	—

The information in this document is subject to change without notice. Before using this document, please confirm that this is the latest version.
 Not all devices/types available in every country. Please check with local NEC representative for availability and additional information.

ELECTRICAL CHARACTERISTICS ($T_j = 25^\circ\text{C}$, $R_{GK} = 1\text{ k}\Omega$)

Parameter	Symbol	Conditions	Specifications			Unit	Remarks
			MIN.	TYP.	MAX.		
Repeat peak off-state current	I_{DRM}	$V_{DM} = V_{DRM}$	$T_j = 25^\circ\text{C}$		10	μA	–
			$T_j = 125^\circ\text{C}$		200		–
Repetitive peak reverse current	I_{RRM}	$V_{RM} = V_{RRM}$	$T_j = 25^\circ\text{C}$		10	μA	–
			$T_j = 125^\circ\text{C}$		200	V	Refer to Figure 1.
On voltage	V_{TM}	$T_j = 25^\circ\text{C}$, $I_{TM} = 4\text{ A}$	–	–	2.2	V	Refer to Figure 9.
Gate trigger voltage	V_{GT}	$V_{DM} = 6\text{ V}$, $R_L = 100\ \Omega$	–	–	0.8	μA	Refer to Figure 8.
Gate trigger current	I_{GT}	$V_{DM} = 6\text{ V}$, $R_L = 100\ \Omega$	–	–	300	V	–
Gate non-trigger voltage	V_{GD}	$T_j = 125^\circ\text{C}$, $V_{DM} = \frac{1}{2}V_{DRM}$	0.2	–	–	V	–
Critical rate of-rise of off-state voltage	dv/dt	$T_j = 125^\circ\text{C}$, $V_{DM} = \frac{2}{3}V_{DRM}$	10	–	–	$\text{V}/\mu\text{s}$	–
Holding current	I_H	$T_j = 25^\circ\text{C}$, $V_D = 24\text{ V}$	–	–	10	mA	–
Commutating turn-off time	T_q	$T_j = 125^\circ\text{C}$, $I_T = 2\text{ A}$ $V_{DM} = \frac{2}{3}V_{DRM}$, $V_R = 50\text{ V}$ $dv/dt = 10\text{ V}/\mu\text{s}$	–	–	15	μs	
Turn-on time	T_{gt}	$T_j = 125^\circ\text{C}$, $V_{DM} = \frac{2}{3}V_{DRM}$ $I_{TM} = 30\text{ A}$ $I_G = 5\text{ mA}$, $t_{IG} = 5\ \mu\text{s}$	–	–	2	μs	–
Thermal resistance	$R_{th(j-c)}$	Junction-to-case DC	–	–	10	$^\circ\text{C}/\text{W}$	Refer to Figure 13.
	$R_{th(j-a)}$	Junction-to-ambient DC	–	–	75		

TYPICAL CHARACTERISTICS ($T_a = 25^\circ\text{C}$)

Figure 1. i_T vs. v_T Characteristics

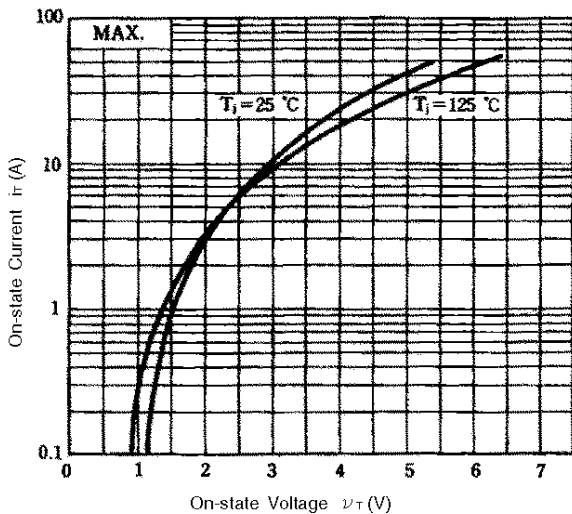

Figure 2. I_{TSM} Rating

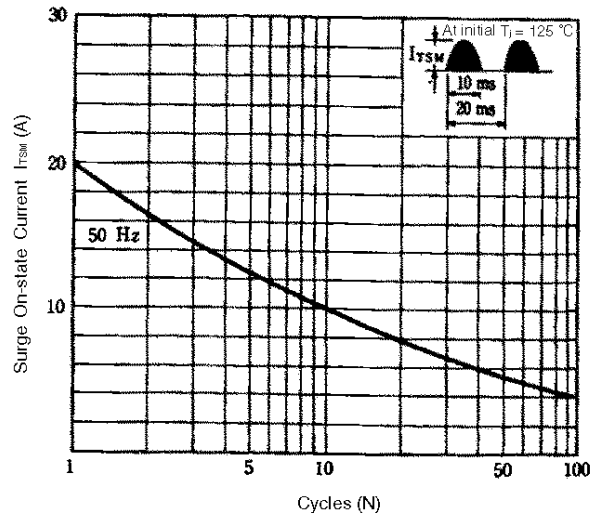

Figure 3. I_{TRM} vs. t_P Rating

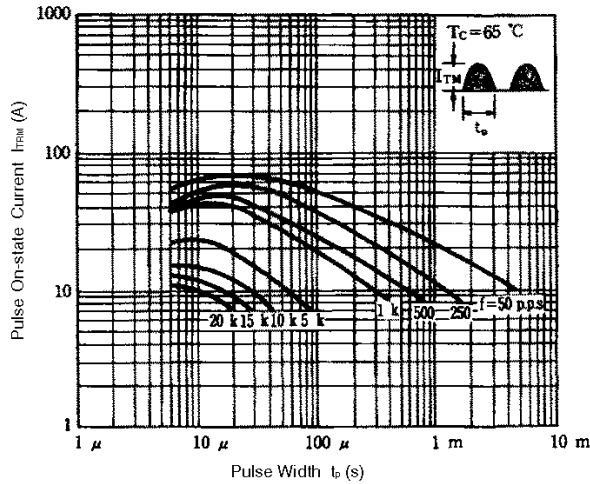

Figure 4. I_{TRM} vs. t_P Rating

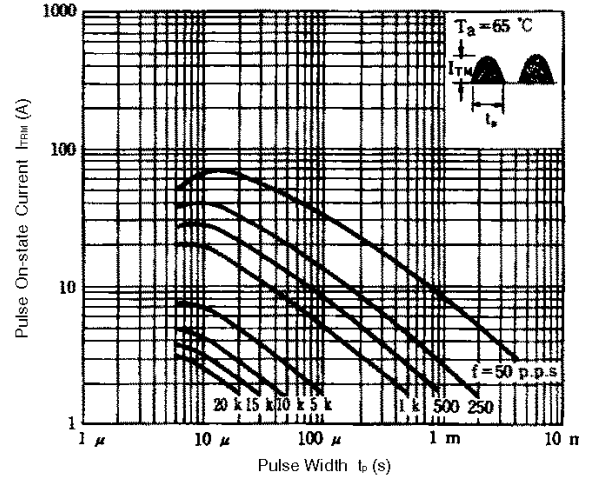

Figure 5. $P_{T(AV)}$ vs. $I_{T(AV)}$ Characteristics

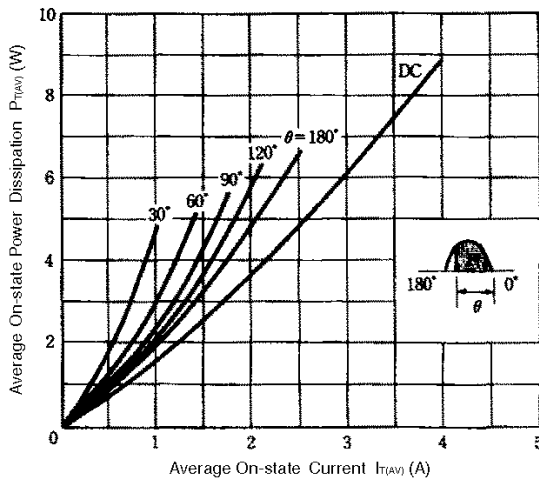

Figure 6. T_C vs. $I_{T(AV)}$ Rating

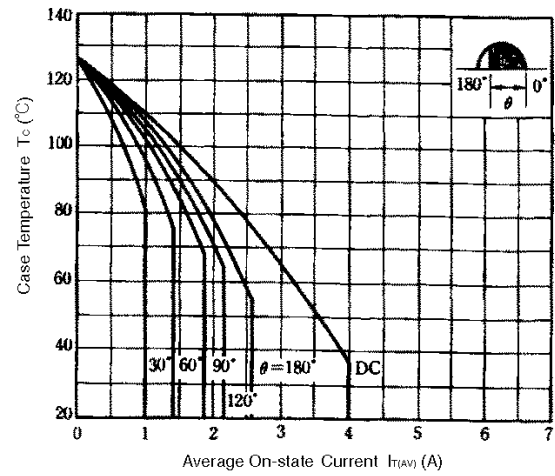

Figure 7. T_A vs. $I_{T(AV)}$ Rating

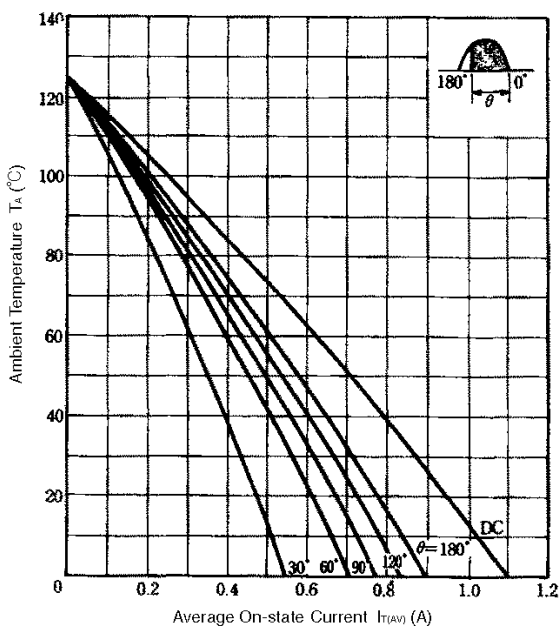

Figure 8. I_{GT} vs. T_A Example of Characteristics

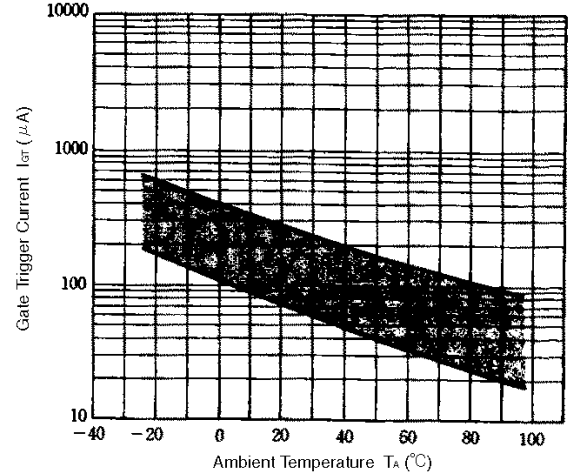

Figure 9. V_{GT} vs. T_A Example of Characteristics

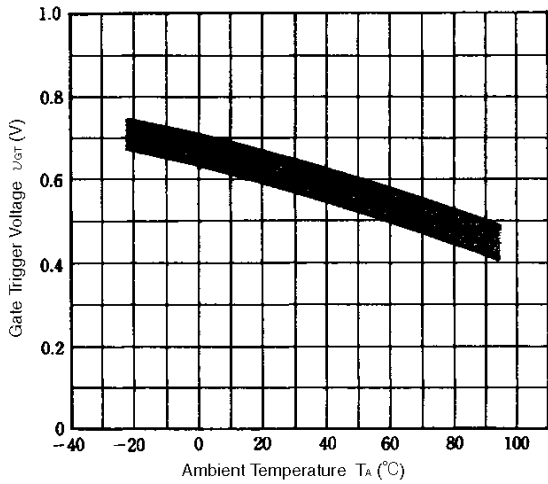

Figure 10. i_{GS} vs. τ Example of Characteristics

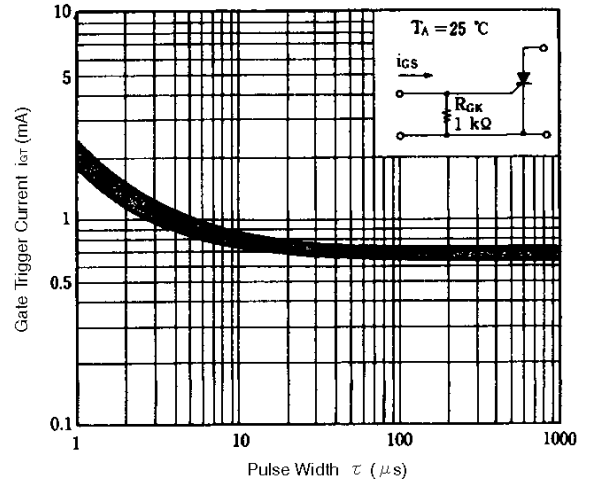

Figure 11. V_{GT} vs. τ Example of Characteristics

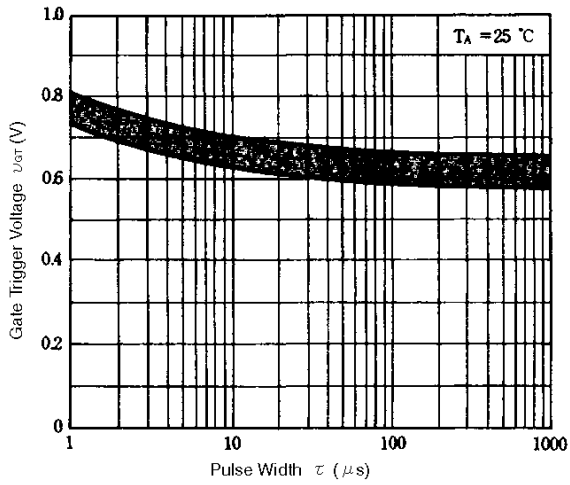

Figure 12. I_H vs. T_A Example of Characteristics

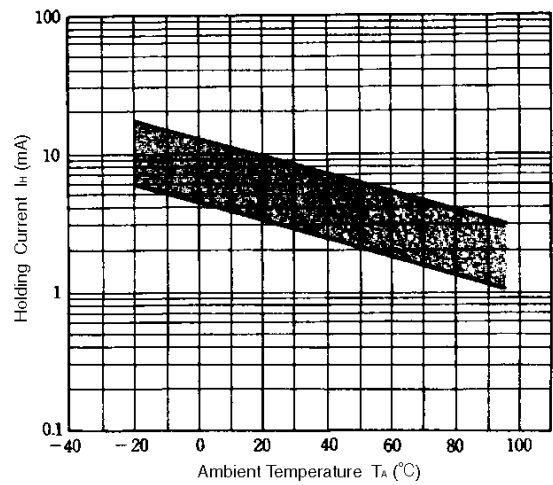
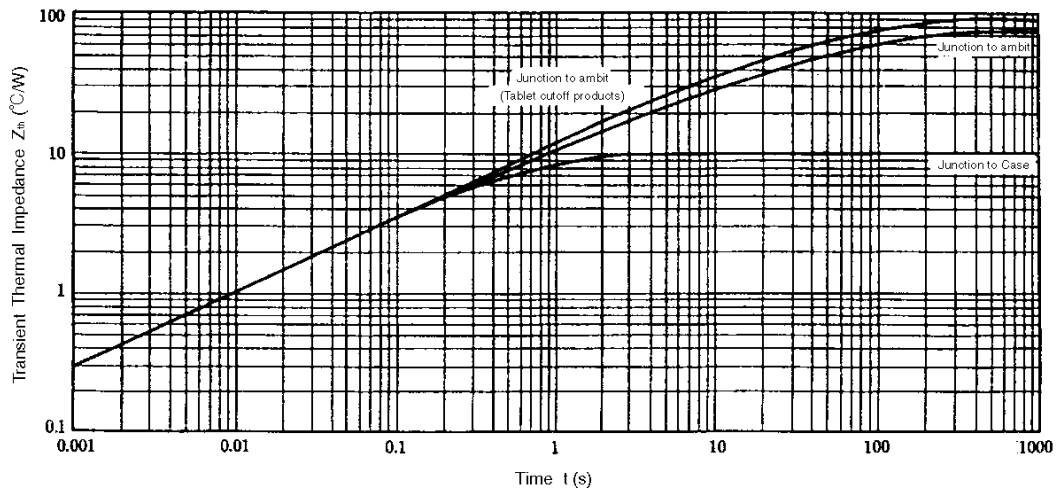

Figure 13. Z_{th} Characteristics



[MEMO]

- **The information in this document is current as of July, 2001. The information is subject to change without notice. For actual design-in, refer to the latest publications of NEC's data sheets or data books, etc., for the most up-to-date specifications of NEC semiconductor products. Not all products and/or types are available in every country. Please check with an NEC sales representative for availability and additional information.**
 - No part of this document may be copied or reproduced in any form or by any means without prior written consent of NEC. NEC assumes no responsibility for any errors that may appear in this document.
 - NEC does not assume any liability for infringement of patents, copyrights or other intellectual property rights of third parties by or arising from the use of NEC semiconductor products listed in this document or any other liability arising from the use of such products. No license, express, implied or otherwise, is granted under any patents, copyrights or other intellectual property rights of NEC or others.
 - Descriptions of circuits, software and other related information in this document are provided for illustrative purposes in semiconductor product operation and application examples. The incorporation of these circuits, software and information in the design of customer's equipment shall be done under the full responsibility of customer. NEC assumes no responsibility for any losses incurred by customers or third parties arising from the use of these circuits, software and information.
 - While NEC endeavours to enhance the quality, reliability and safety of NEC semiconductor products, customers agree and acknowledge that the possibility of defects thereof cannot be eliminated entirely. To minimize risks of damage to property or injury (including death) to persons arising from defects in NEC semiconductor products, customers must incorporate sufficient safety measures in their design, such as redundancy, fire-containment, and anti-failure features.
 - NEC semiconductor products are classified into the following three quality grades:
"Standard", "Special" and "Specific". The "Specific" quality grade applies only to semiconductor products developed based on a customer-designated "quality assurance program" for a specific application. The recommended applications of a semiconductor product depend on its quality grade, as indicated below. Customers must check the quality grade of each semiconductor product before using it in a particular application.
 - "Standard": Computers, office equipment, communications equipment, test and measurement equipment, audio and visual equipment, home electronic appliances, machine tools, personal electronic equipment and industrial robots
 - "Special": Transportation equipment (automobiles, trains, ships, etc.), traffic control systems, anti-disaster systems, anti-crime systems, safety equipment and medical equipment (not specifically designed for life support)
 - "Specific": Aircraft, aerospace equipment, submersible repeaters, nuclear reactor control systems, life support systems and medical equipment for life support, etc.
- The quality grade of NEC semiconductor products is "Standard" unless otherwise expressly specified in NEC's data sheets or data books, etc. If customers wish to use NEC semiconductor products in applications not intended by NEC, they must contact an NEC sales representative in advance to determine NEC's willingness to support a given application.
- (Note)
- (1) "NEC" as used in this statement means NEC Corporation and also includes its majority-owned subsidiaries.
 - (2) "NEC semiconductor products" means any semiconductor product developed or manufactured by or for NEC (as defined above).