



20L15T 20L15TS

SCHOTTKY RECTIFIER

20 Amps

Major Ratings and Characteristics



Characteristics	Values	Units
$I_{F(AV)}$ Rectangular waveform	20	A
V_{RRM}	15	V
I_{FSM} @tp=5µs sine	700	A
V_F @19Apk, $T_J=125^\circ\text{C}$ (Typical)	0.25	V
T_J range	-55 to 125	$^\circ\text{C}$

Description/Features

The Schottky rectifier module has been optimized for ultra low forward voltage drop specifically for the OR-ing of parallel power supplies. The proprietary barrier technology allows for reliable operation up to 125 °C junction temperature. Typical applications are in parallel switching power supplies, converters, reverse battery protection, and redundant power subsystems.

- 125°C T_J operation ($V_R < 5V$)
- Single diode configuration
- Optimized for OR-ing applications
- Ultra low forward voltage drop
- Guard ring for enhanced ruggedness and long term reliability
- High purity, high temperature epoxy encapsulation for enhanced mechanical strength and moisture resistance

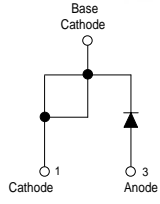
Case Styles

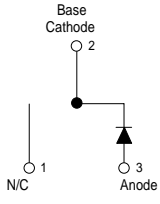
20L15T	20L15TS
  <p>TO-220AC</p>	  <p>D²PAK</p>

Voltage Ratings

Partnumber	Values
V_R Max. DC Reverse Voltage (V) @ $T_J = 100^\circ\text{C}$	15
V_{RWM} Max. Working Peak Reverse Voltage (V) @ $T_J = 100^\circ\text{C}$	

Absolute Maximum Ratings

Parameters	Values	Units	Conditions
$I_{F(AV)}$ Max. Average Forward Current * See Fig. 5	20	A	50% duty cycle @ $T_C = 85^\circ\text{C}$, rectangular waveform
I_{FSM} Max. Peak One Cycle Non-Repetitive Surge Current * See Fig. 7	700	A	Following any rated load condition and with rated V_{RWM} applied
	330		
E_{AS} Non-Repetitive Avalanche Energy	10	mJ	$T_J = 25^\circ\text{C}$, $I_{AS} = 2\text{Amps}$, $L = 6\text{mH}$
I_{AR} Repetitive Avalanche Current	2	A	Current decaying linearly to zero in $1\mu\text{sec}$ Frequency limited by T_J max. $V_A = 1.5 \times V_R$ typical

Electrical Specifications

Parameters	Values		Units	Conditions	
	Typ.	Max.			
V_{FM} Forward Voltage Drop * See Fig. 1 (1)	-	0.41	V	@ 19A	$T_J = 25^\circ\text{C}$
	-	0.52	V	@ 40A	
	0.25	0.33	V	@ 19A	$T_J = 125^\circ\text{C}$
	0.37	0.50	V	@ 40A	
I_{RM} Reverse Leakage Current * See Fig. 2 (1)	-	10	mA	$T_J = 25^\circ\text{C}$	$V_R = \text{rated } V_R$
	-	600	mA	$T_J = 100^\circ\text{C}$	
$V_{F(TO)}$ Threshold Voltage	0.182		V	$T_J = T_J \text{ max.}$	
r_t Forward Slope Resistance	7.6		m Ω		
C_T Max. Junction Capacitance	-	2000	pF	$V_R = 5V_{DC}$, (test signal range 100Khz to 1Mhz) 25°C	
L_S Typical Series Inductance	8	-	nH	Measured lead to lead 5mm from package body	
dv/dt Max. Voltage Rate of Change (Rated V_R)	10,000		V/ μs		

(1) Pulse Width < 300 μs , Duty Cycle < 2%

Thermal-Mechanical Specifications

Parameters	Values	Units	Conditions
T_J Max. Junction Temperature Range	-55 to 125	$^\circ\text{C}$	
T_{stg} Max. Storage Temperature Range	-55 to 150	$^\circ\text{C}$	
R_{thJC} Max. Thermal Resistance Junction to Case	1.5	$^\circ\text{C/W}$	DC operation * See Fig. 4
R_{thCS} Typical Thermal Resistance Case to Heatsink	0.50	$^\circ\text{C/W}$	Mounting surface, smooth and greased For TO-220
R_{thJA} Max. Thermal Resistance Junction to Ambient	40	$^\circ\text{C/W}$	DC operation For D ² Pak
wt Approximate Weight	2(0.07)	g(oz.)	
T Mounting Torque	Min.	6(5)	Non-lubricated threads
	Max.	12(10)	

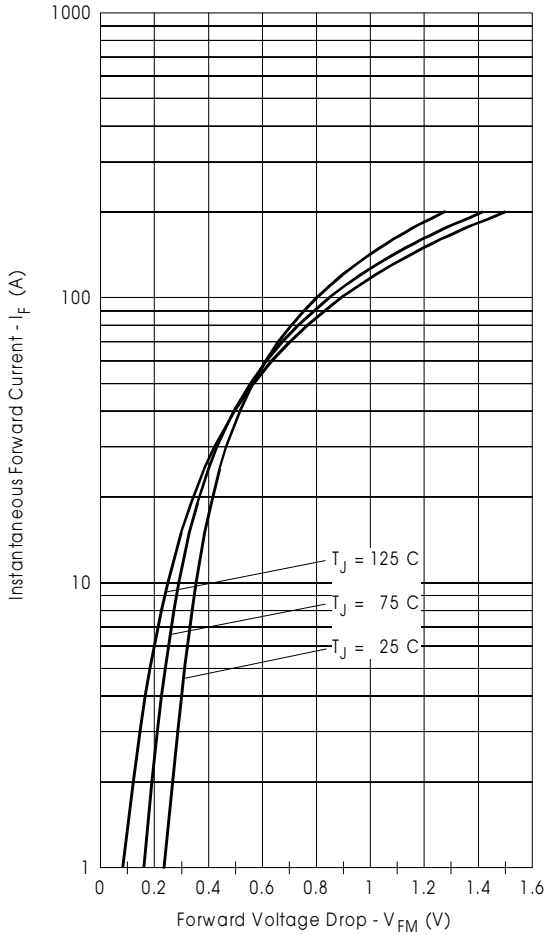

Fig. 1 - Maximum Forward Voltage Drop Characteristics

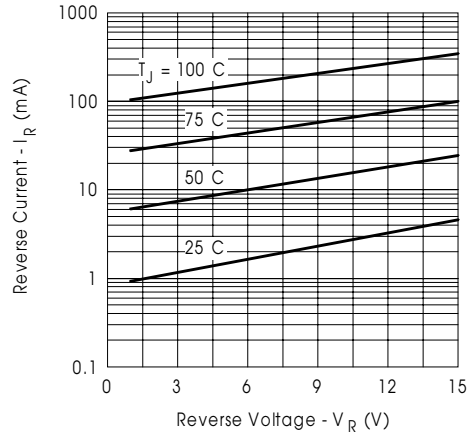

Fig. 2 - Typical Values of Reverse Current Vs. Reverse Voltage

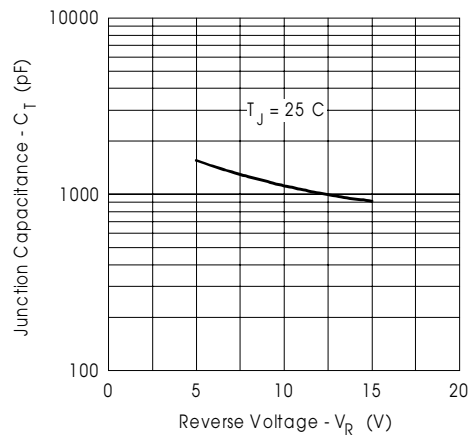

Fig. 3 - Typical Junction Capacitance Vs. Reverse Voltage

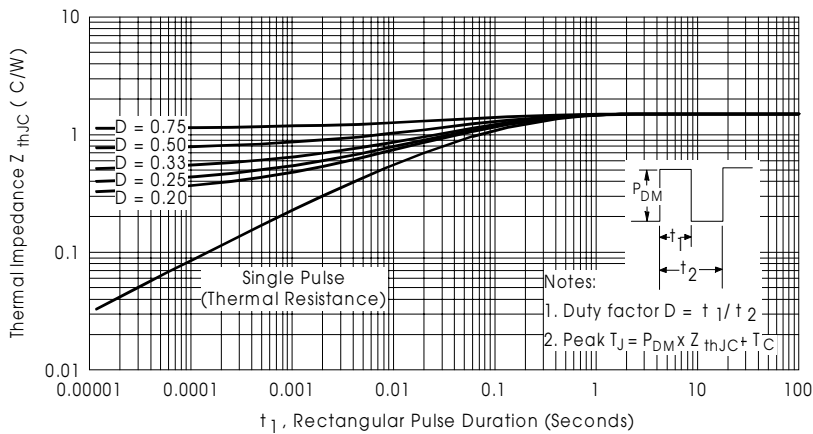

Fig. 4 - Maximum Thermal Impedance Z_{thJC} Characteristics

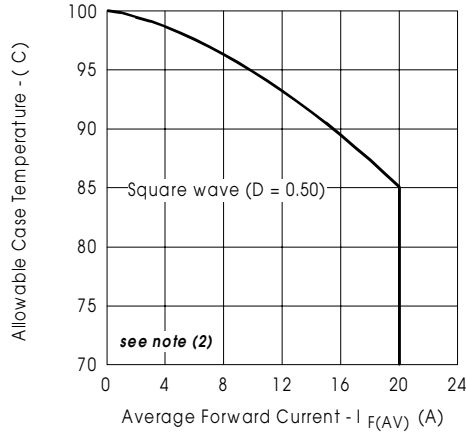

Fig. 5 - Maximum Allowable Case Temperature Vs. Average Forward Current

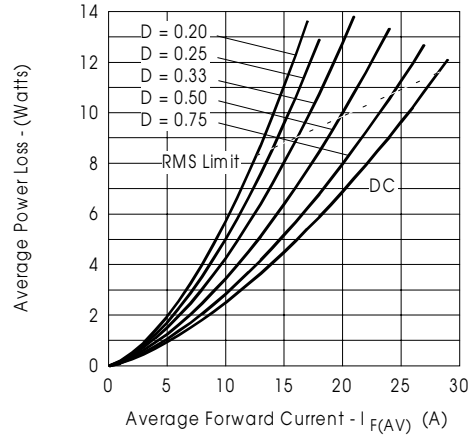

Fig. 6 - Forward Power Loss Characteristics

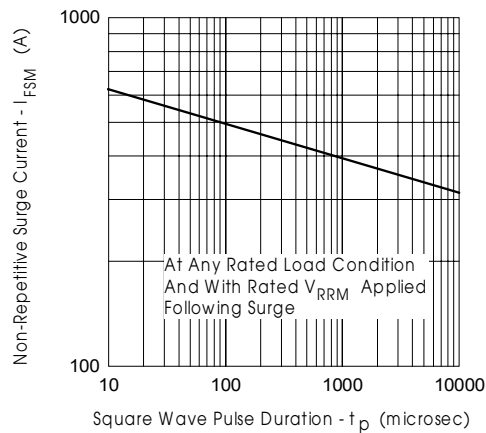

Fig. 7 - Maximum Non-Repetitive Surge Current

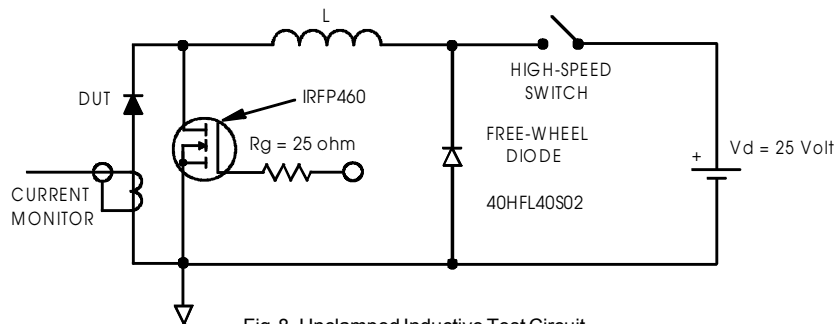

Fig. 8 - Unclamped Inductive Test Circuit

(2) Formula used: $T_c = T_j - (P_d + P_{d_{REV}}) \times R_{thJC}$;

P_d = Forward Power Loss = $I_{F(AV)} \times V_{FM}$ @ ($I_{F(AV)} / D$) (see Fig. 6);

$P_{d_{REV}}$ = Inverse Power Loss = $V_{R1} \times I_R (1 - D)$; I_R @ $V_{R1} = 80\%$ rated V_R

Outline Table

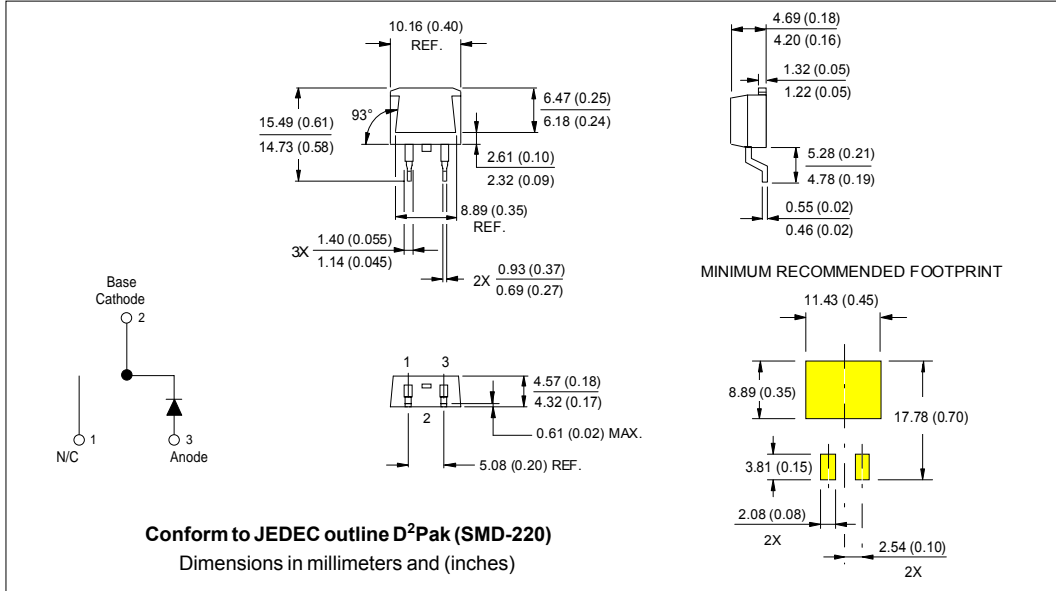

Tape & Reel Information

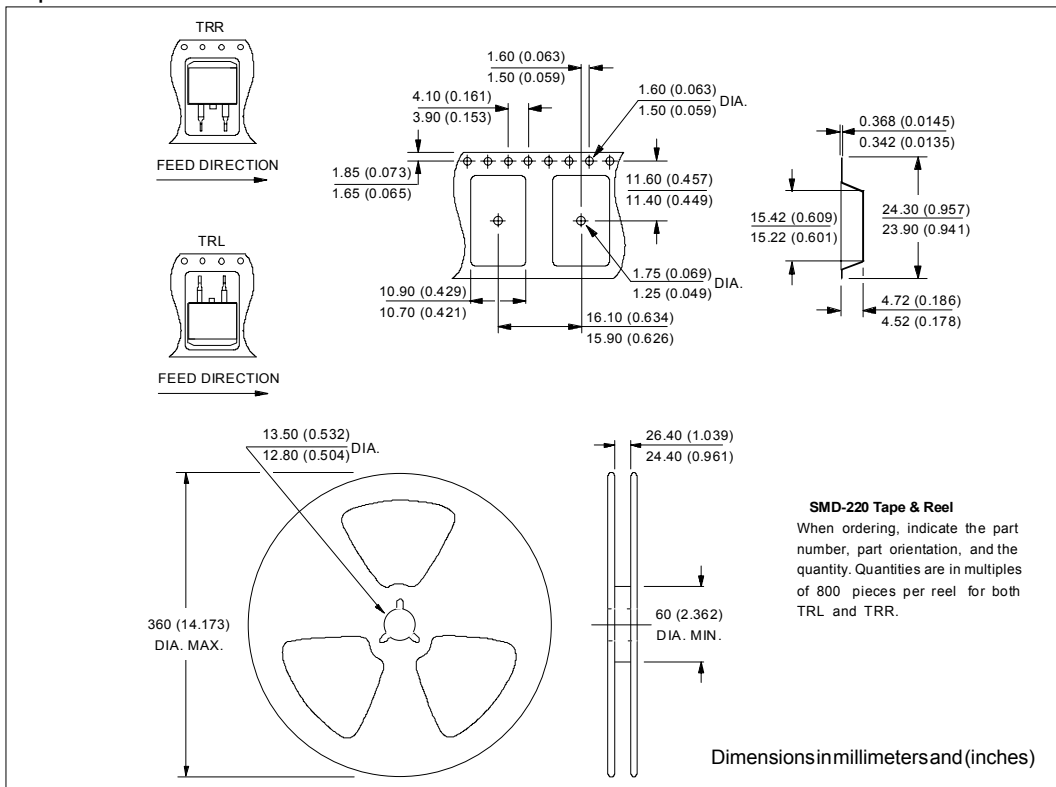

Outline Table

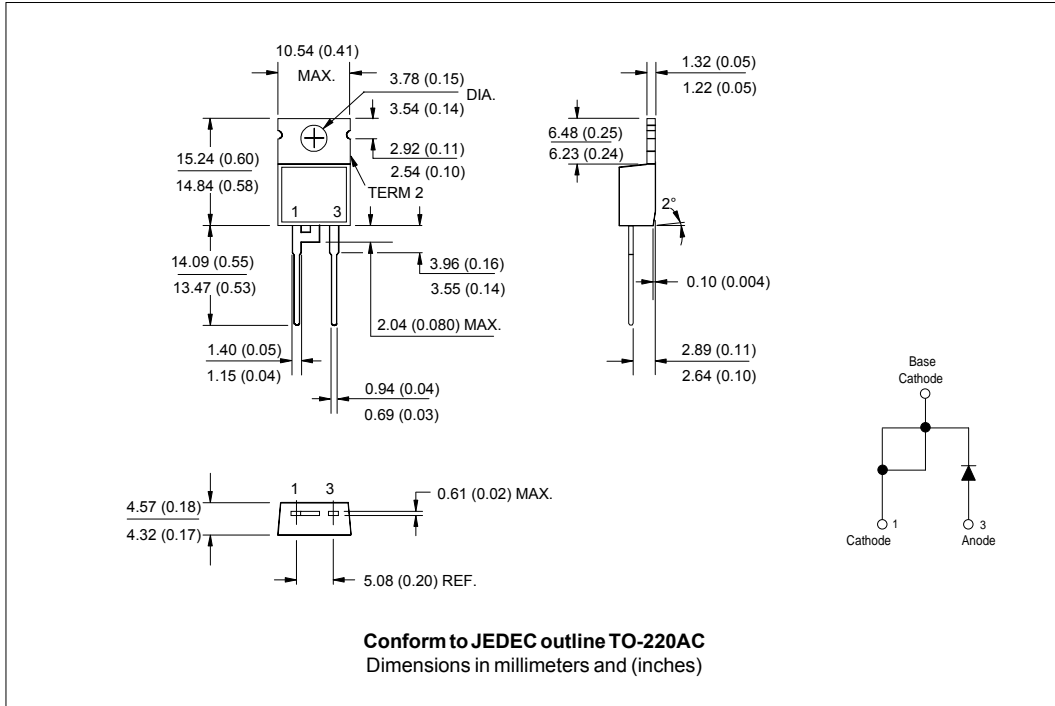

Data and specifications subject to change without notice.
 This product has been designed and qualified for Industrial Level.
 Qualification Standards can be found on IR's Web site.