

International IOR Rectifier

208CMQ060

SCHOTTKY RECTIFIER

200 Amp

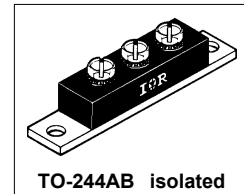

Major Ratings and Characteristics

Characteristics	208CMQ...	Units
$I_{F(AV)}$ Rectangular waveform	200	A
V_{RRM}	60	V
I_{FSM} @tp = 5 μ s sine	16,000	A
V_F @100Apk, $T_J = 125^\circ\text{C}$ (per leg)	0.59	V
T_J range	-55 to 150	$^\circ\text{C}$

Description/Features

The 208CMQ high current Schottky rectifier module series has been optimized for low reverse leakage at high temperature.

The proprietary barrier technology allows for reliable operation up to 150 $^\circ\text{C}$ junction temperature. Typical applications are in high current switching power supplies, plating power supplies, UPS systems, converters, free-wheeling diodes, welding, and reverse battery protection.

- 150 $^\circ\text{C}$ T_J operation
- Center tap module - Isolated Base
- High purity, high temperature epoxy encapsulation for enhanced mechanical strength and moisture resistance
- Low forward voltage drop
- High frequency operation
- Guard ring for enhanced ruggedness and long term reliability

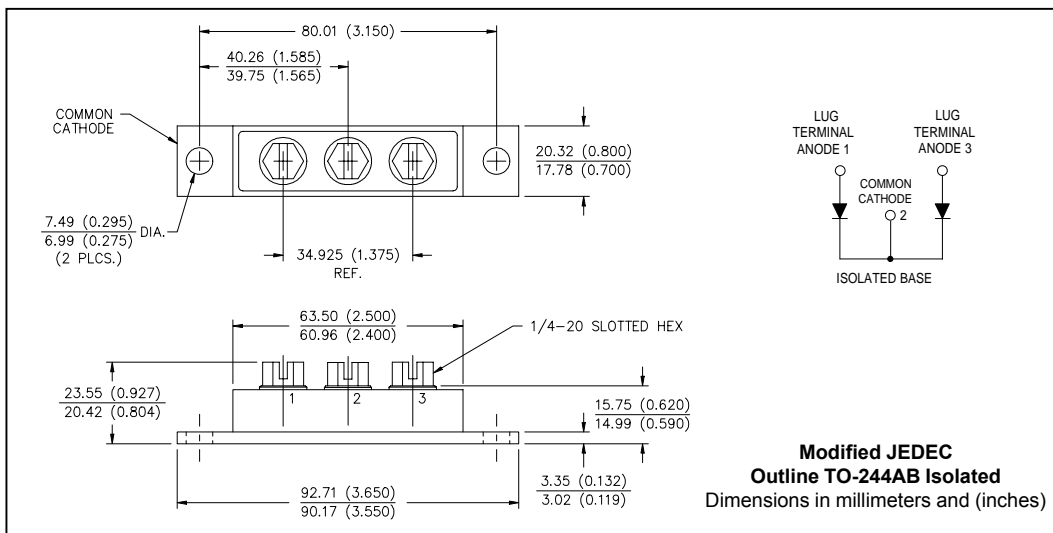

Voltage Ratings

Part number	208CMQ060
V_R Max. DC Reverse Voltage (V)	60
V_{RWM} Max. Working Peak Reverse Voltage (V)	

Absolute Maximum Ratings

Parameters	208CMQ	Units	Conditions
$I_{F(AV)}$ Max. Average Forward Current (Per Leg) * See Fig. 5 (Per Device)	100 200	A	50% duty cycle @ $T_C = 90^\circ\text{C}$, rectangular wave form
I_{FSM} Max. Peak One Cycle Non-Repetitive Surge Current (Per Leg) * See Fig. 7	16,000 2,100	A	5 μs Sine or 3 μs Rect. pulse 10ms Sine or 6ms Rect. pulse Following any rated load condition and with rated V_{RWM} applied
E_{AS} Non-Repetitive Avalanche Energy (Per Leg)	15	mJ	$T_J = 25^\circ\text{C}$, $I_{AS} = 1$ Amps, $L = 30$ mH
I_{AR} Repetitive Avalanche Current (Per Leg)	1	A	Current decaying linearly to zero in 1 μsec Frequency limited by T_J max. $V_A = 1.5 \times V_R$ typical

Electrical Specifications

Parameters	208CMQ	Units	Conditions
V_{FM} Max. Forward Voltage Drop (Per Leg) * See Fig. 1 (1)	0.68	V	@ 100A $T_J = 25^\circ\text{C}$
	0.83	V	@ 200A
	0.59	V	@ 100A $T_J = 125^\circ\text{C}$
	0.75	V	@ 200A
I_{RM} Max. Reverse Leakage Current (Per Leg) * See Fig. 2 (1)	1.1	mA	$T_J = 25^\circ\text{C}$
	300	mA	$T_J = 125^\circ\text{C}$ $V_R = \text{rated } V_R$
$V_{F(TO)}$ Threshold Voltage	0.32	V	$T_J = T_J \text{ max.}$
r_t Forward Slope Resistance	2.1	m Ω	
C_T Max. Junction Capacitance (Per Leg)	6000	pF	$V_R = 5V_{DC}$, (test signal range 100Khz to 1Mhz) 25°C
L_S Typical Series Inductance (Per Leg)	7.0	nH	From top of terminal hole to mounting plane
dv/dt Max. Voltage Rate of Change	10000	V/ μs	(Rated V_R)
V_{RMS} Insulation Voltage	1000	V	

Thermal-Mechanical Specifications

(1) Pulse Width < 300 μs , Duty Cycle < 2%

Parameters	208CMQ	Units	Conditions	
T_J Max. Junction Temperature Range	-55 to 150	$^\circ\text{C}$		
T_{stg} Max. Storage Temperature Range	-55 to 150	$^\circ\text{C}$		
R_{thJC} Max. Thermal Resistance Junction to Case (Per Leg)	0.70	$^\circ\text{C/W}$	DC operation * See Fig. 4	
R_{thJC} Max. Thermal Resistance Junction to Case (Per Package)	0.35	$^\circ\text{C/W}$	DC operation	
R_{thCS} Typical Thermal Resistance, Case to Heatsink	0.10	$^\circ\text{C/W}$	Mounting surface, smooth and greased	
wt Approximate Weight	79 (2.80)	g (oz.)		
T Mounting Torque	Min.	24 (20)	Kg-cm (lbf-in)	
	Max.	35 (30)		
	Mounting Torque Center Hole	Typ.		13.5 (12)
	Terminal Torque	Min.		35 (30)
		Max.		46 (40)
Case Style	TO-244AB Isolated		Modified JEDEC	

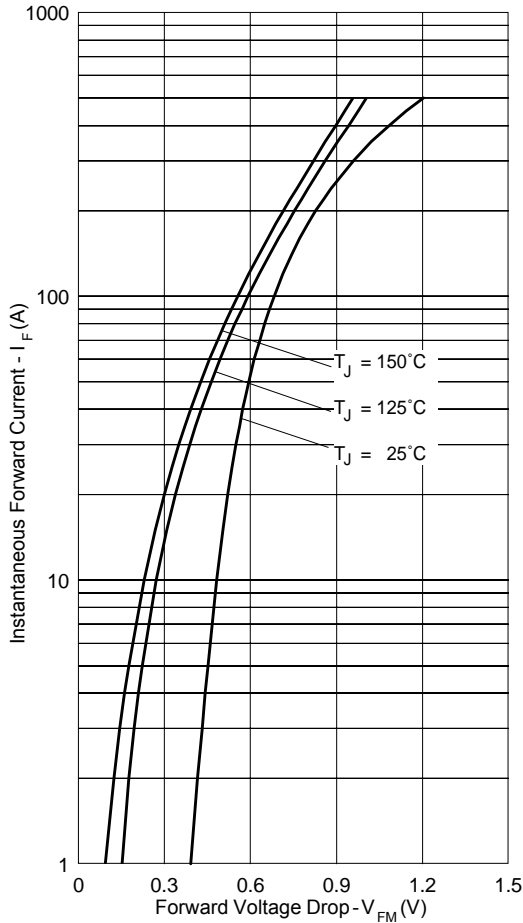

Fig. 1 - Max. Forward Voltage Drop Characteristics

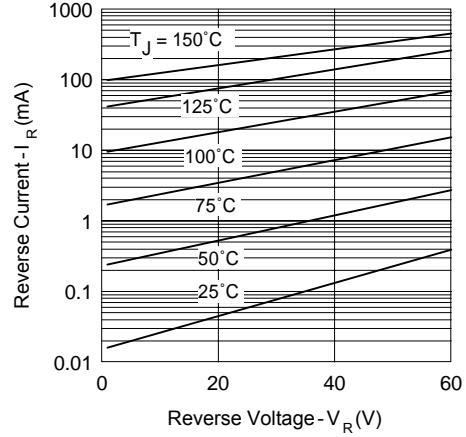

Fig. 2 - Typical Values Of Reverse Current Vs. Reverse Voltage

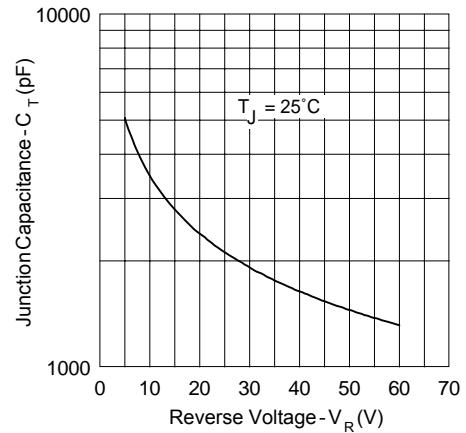

Fig. 3 - Typical Junction Capacitance Vs. Reverse Voltage

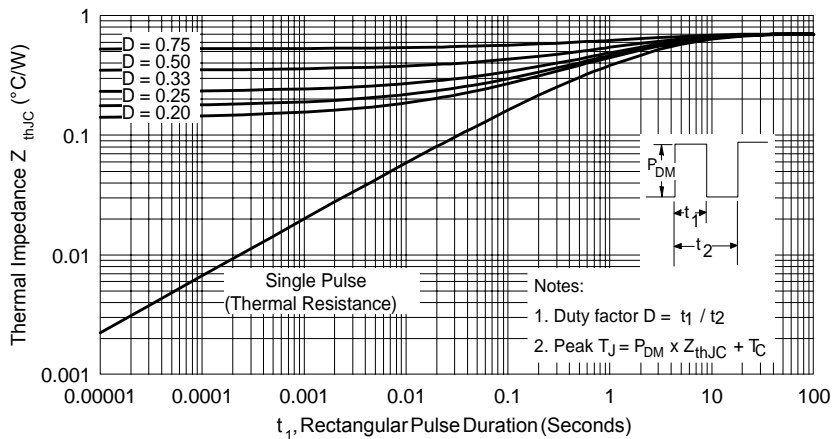

Fig. 4 - Max. Thermal Impedance Z_{thJC} Characteristics (Per Leg)

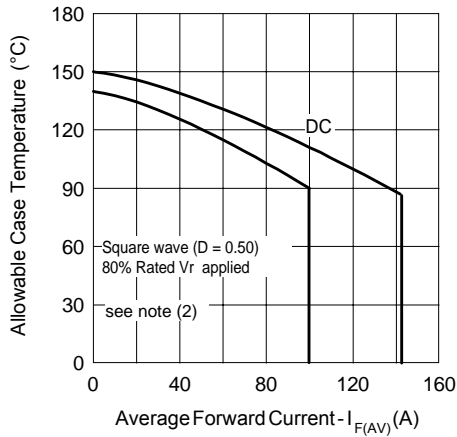

Fig. 5 - Max. Allowable Case Temperature Vs. Average Forward Current

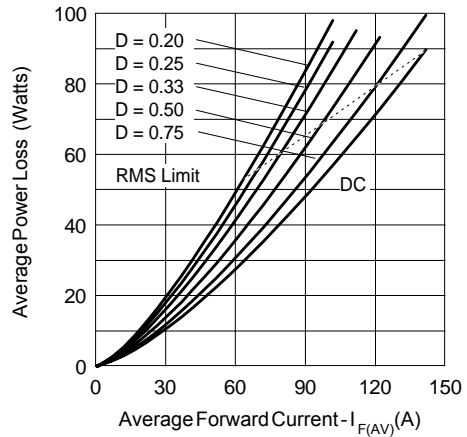

Fig. 6 - Forward Power Loss Characteristics

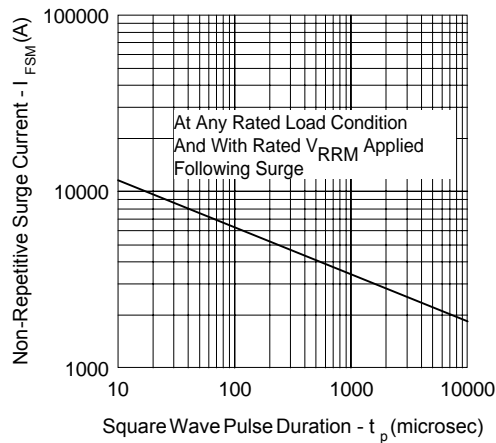

Fig. 7 - Max. Non-Repetitive Surge Current

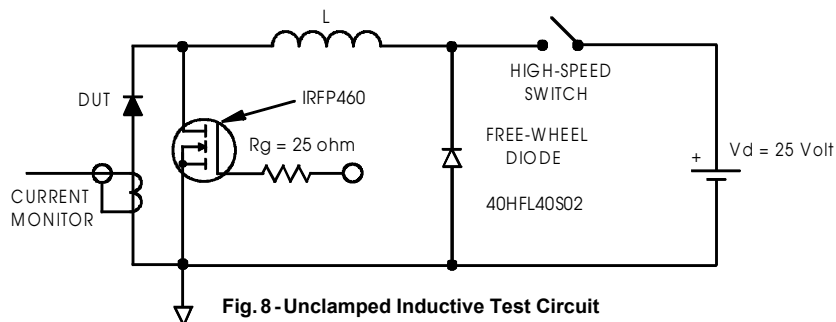

Fig. 8 - Unclamped Inductive Test Circuit

(2) Formula used: $T_C = T_J - (P_d + P_{d_{REV}}) \times R_{thJC}$;

P_d = Forward Power Loss = $I_{F(AV)} \times V_{FM} @ (I_{F(AV)} / D)$ (see Fig. 6);

$P_{d_{REV}}$ = Inverse Power Loss = $V_{R1} \times I_R (1 - D)$; $I_R @ V_{R1} = 80\%$ rated V_R

Ordering Information Table

Device Code				
208	C	M	Q	060
①	②	③	④	⑤
1	-	Current Rating: 200A		
2	-	Common Cathode		
3	-	Module		
4	-	Schottky Q Series		
5	-	Voltage Rating: 60V		

Data and specifications subject to change without notice.
This product has been designed and qualified for Industrial Level.
Qualification Standards can be found on IR's Web site.