

Variable Capacitance Diode

Description

The 1T405 is a variable capacitance diode designed for electronic tuning of wide-band CATV tuners using a super-small-miniature flat package (SSVC).

Features

- Super-small-miniature flat package
- Low series resistance: 0.85 Ω Max. (f=470 MHz)
- Large capacitance ratio: 12.5 Typ. (C₂/C₂₅)
- Small leakage current: 10 nA Max. (V_R=28 V)
- Capacitance deviation in a matching group: within 2%

Applications

Electronic tuning of UHF and wide-band CATV tuners

Structure

Silicon epitaxial planar type diode

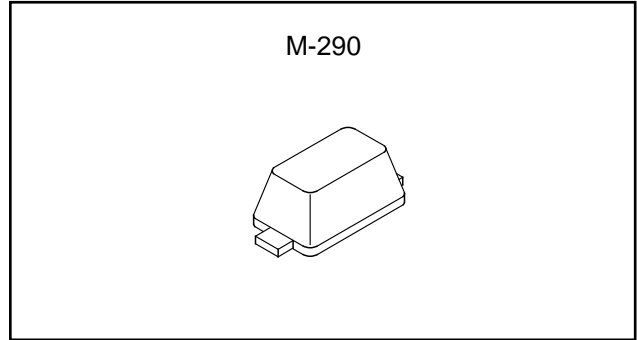

Absolute Maximum Ratings (Ta=25 °C)

- Reverse voltage V_R 34 V
- Operating temperature T_{opr} -20 to +75 °C
- Storage temperature T_{stg} -65 to +150 °C

Electrical Characteristics

(Ta=25 °C)

Item	Symbol	Conditions	Min.	Typ.	Max.	Unit
Reverse current	I _R	V _R =28 V			10	nA
Reverse voltage	V _R	I _R =1 μA	34			V
Diode capacitance	C ₂	V _R =2 V, f=1 MHz	32.96		38.96	pF
	C ₂₅	V _R =25 V, f=1 MHz	2.53		2.96	pF
Capacitance ratio	C ₂ /C ₂₅		12.0	12.5		
Series resistance	r _s	C _D =14 pF, f=470 MHz			0.85	Ω
Capacitance deviation in a matching group	ΔC	V _R =2 to 25 V, f=1 MHz			2	%

Sony reserves the right to change products and specifications without prior notice. This information does not convey any license by any implication or otherwise under any patents or other right. Application circuits shown, if any, are typical examples illustrating the operation of the devices. Sony cannot assume responsibility for any problems arising out of the use of these circuits.

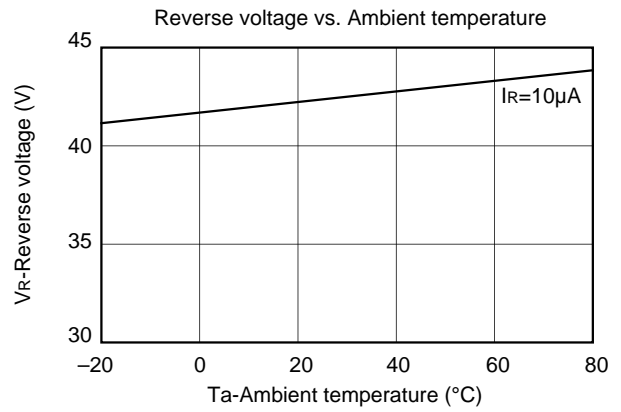
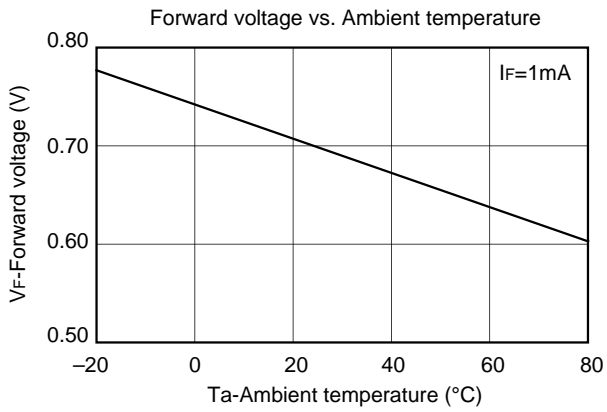
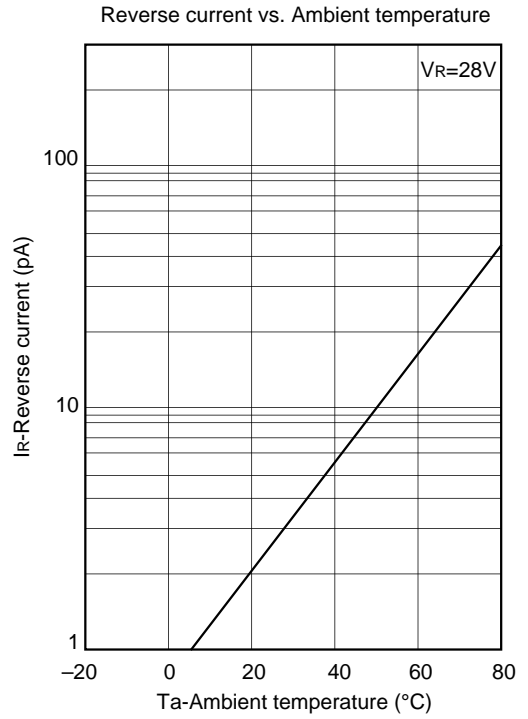
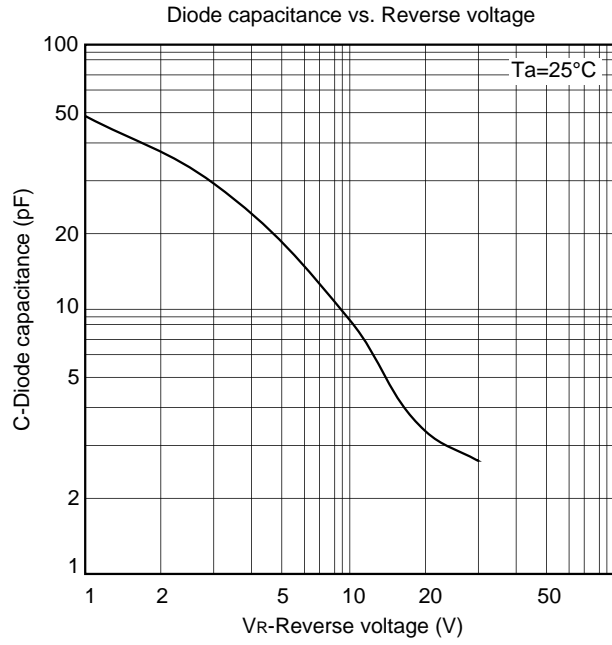

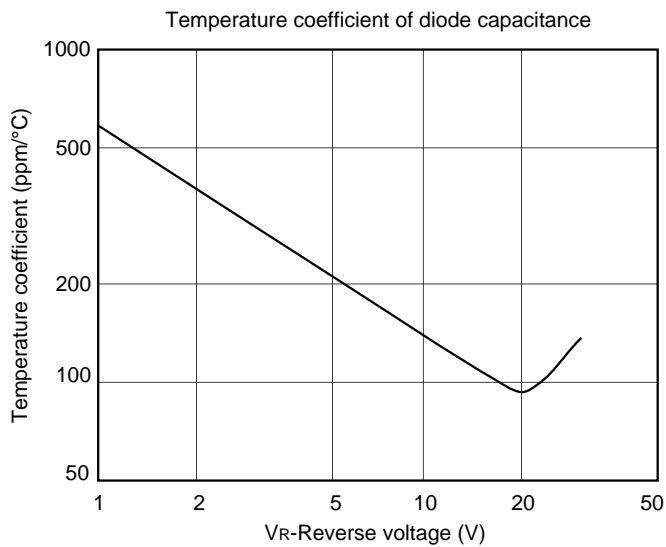
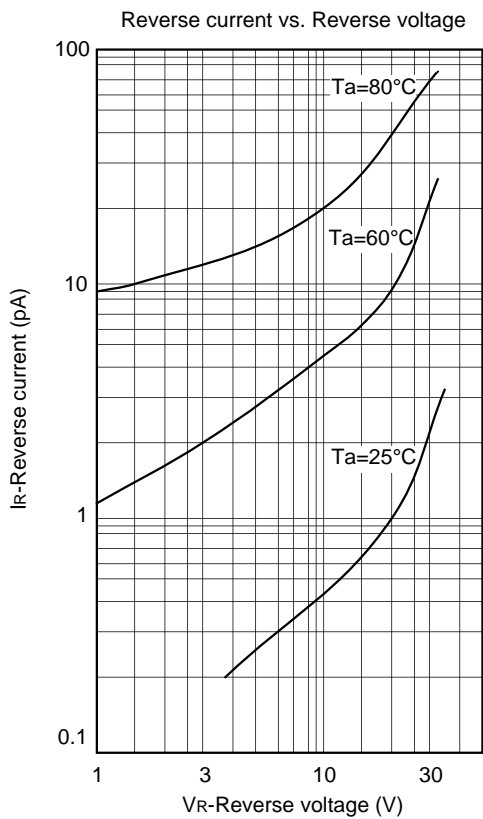
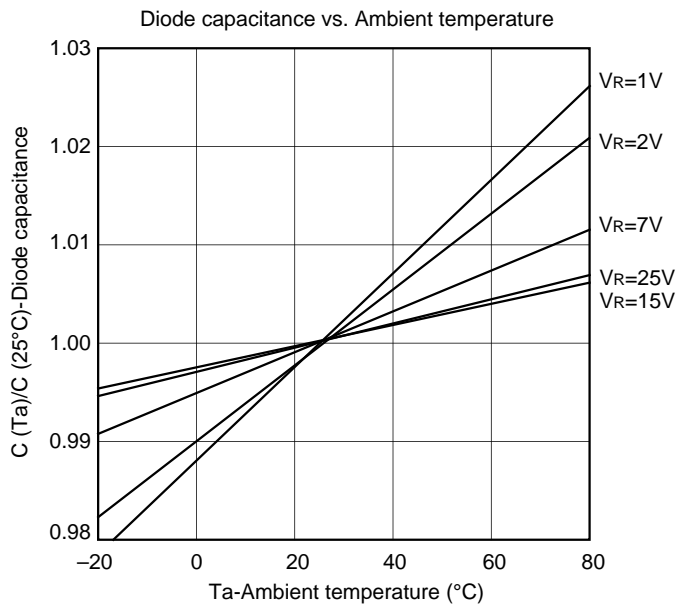

Package Outline Unit : mm

M-290

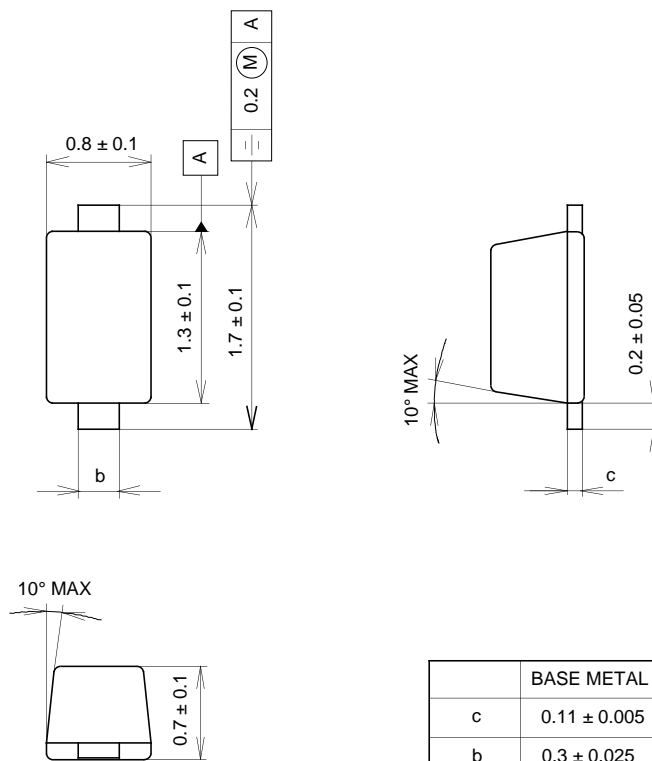

	BASE METAL	WITH PLATING
c	0.11 ± 0.005	$0.11 \begin{smallmatrix} +0.05 \\ -0.01 \end{smallmatrix}$
b	0.3 ± 0.025	$0.3 \begin{smallmatrix} +0.05 \\ -0.02 \end{smallmatrix}$

SONY CODE	M-290
EIAJ CODE	_____
JEDEC CODE	_____

PACKAGE MATERIAL	EPOXY RESIN
LEAD TREATMENT	SOLDER PLATING
LEAD MATERIAL	COPPER
PACKAGE WEIGHT	0.002g

Mark

