

300 mA HIGH-WITHSTANDING-VOLTAGE MOLD SCR

DESCRIPTION

The 03P4MG and 03P6MG are P-gate fully diffused mold SCRs with an average on-state current of 300 mA. The repeat peak off-state voltages (and reverse voltages) are 400 and 600 V.

FEATURES

- 400 and 600 V high-withstanding-voltage series of products
- The non-repetitive withstanding voltage is a high 700 V, making it easy to harmonize the rise voltage of the surge absorber.
- High-sensitivity thyristor ($I_{GT} = 3$ to $50 \mu A$)
- Employs flame-retardant epoxy resin (UL94V-0)

APPLICATIONS

Leakage breakers, SSRs, various type of alarms, consumer electronic equipments and automobile electronic components

PACKAGE DRAWING (Unit: mm)

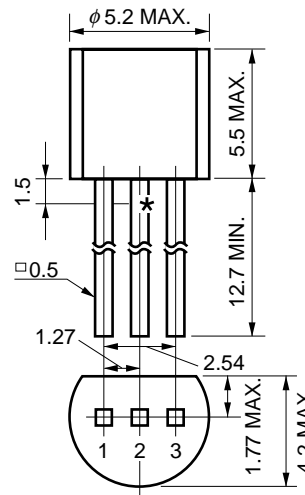

Electrode connection
1: Gate
2: Anode
3: Cathode

*T_c test bench-mark
Standard weight: 0.3 g

ABSOLUTE MAXIMUM RATINGS (T_A = 25°C)

Parameter	Symbol	Ratings		Unit	Remarks
		03P4MG	03P6MG		
Non-repetitive Peak Reverse Voltage	V _{RSM}	700	700	V	R _{GK} = 1 kΩ
Non-repetitive Peak Off-state Voltage	V _{DSM}	700	700	V	R _{GK} = 1 kΩ
Repetitive Peak Reverse Voltage	V _{RRM}	400	600	V	R _{GK} = 1 kΩ
Repetitive Peak Off-state Voltage	V _{DRM}	400	600	V	R _{GK} = 1 kΩ
Average On-state Current	I _{T(AV)}	300 (T _A = 30°C, Single half-wave, θ = 180°)		mA	Refer to Figure 10.
Effective On-state Current	I _{T(RMS)}	470		mA	—
★ Surge On-state Current	I _{TSM}	8 (f = 50 Hz, Sine half-wave, 1 cycle)		A	Refer to Figure 2.
Fusing Current	$\int i^2 dt$	0.15 (1 ms ≤ t ≤ 10 ms)		A ² s	—
Critical Rate of On-state Current of Rise	di _T /dt	20		A/μs	—
Peak Gate Power Dissipation	P _{GM}	100 (f ≥ 50 Hz, Duty ≤ 10%)		mW	Refer to Figure 3.
Average Gate Power Dissipation	P _{G(AV)}	10		mW	Refer to Figure 3.
Peak Gate Forward Current	I _{FGM}	100 (f ≥ 50 Hz, Duty ≤ 10%)		mA	—
Peak Gate Reverse Voltage	V _{RGM}	6		V	—
Junction Temperature	T _j	-40 to +125		°C	—
Storage Temperature	T _{stg}	-55 to +150		°C	—

The information in this document is subject to change without notice. Before using this document, please confirm that this is the latest version.

Not all products and/or types are available in every country. Please check with an NEC Electronics sales representative for availability and additional information.

ELECTRICAL CHARACTERISTICS (T_j = 25°C, R_{θK} = 1 kΩ)

Parameter	Symbol	Conditions	Specifications			Unit	Remarks	
			MIN.	TYP.	MAX.			
Non-repetitive Peak Reverse Current	I _{RRM}	V _{RM} = V _{RDM}	T _j = 25°C	–	–	10	μA	–
			T _j = 125°C	–	–	100	μA	–
Non-repetitive Peak Off-state Current	I _{DRM}	V _{DM} = V _{DRM}	T _j = 25°C	–	–	10	μA	–
			T _j = 125°C	–	–	100	μA	–
Critical Rate-of-rise of Off-state Voltage	dV _D /dt	T _j = 125°C, V _{DM} = $\frac{2}{3}$ V _{DRM}	10	–	–	V/μs	–	
On-state Voltage	V _T	I _T = 4 A	–	–	2.2	V	Refer to Figure 1.	
Gate Trigger Current	I _{GT}	V _{DM} = 6 V, R _L = 100 Ω	3	–	50	μA	–	
Gate Trigger Voltage	V _{GT}	V _{DM} = 6 V, R _L = 100 Ω	–	–	0.8	V	–	
Gate Non-trigger Voltage	V _{GD}	T _j = 125°C, V _{DM} = $\frac{V_{DRM}}{2}$	0.2	–	–	V	–	
Holding Current	I _H	V _{DM} = 24 V, I _{TM} = 4 A	–	–	5	mA	–	
Turn-off Time	t _q	T _j = 125°C, I _T = 200 mA, dI _R /dt = 15 A/μs, V _R ≥ 25 V, V _{DM} = $\frac{2}{3}$ V _{DRM} , dV _D /dt = 10 V/μs	–	60	–	μs	–	
Thermal Resistance	R _{th(j-c)}	Junction-to-case DC	–	–	50	°C/W	Refer to Figure 14.	
	R _{th(j-a)}	Junction-to-ambient DC	–	–	230	°C/W	Refer to Figure 14.	

TYPICAL CHARACTERISTICS (T_A = 25°C)

Figure 1. i_r vs. v_T Characteristics

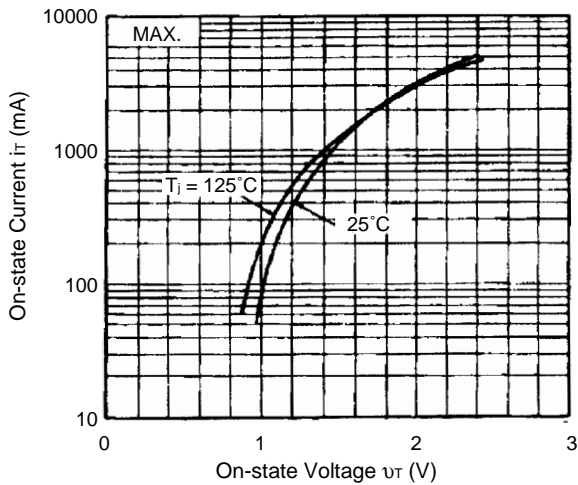

Figure 2. I_{rSM} Rating

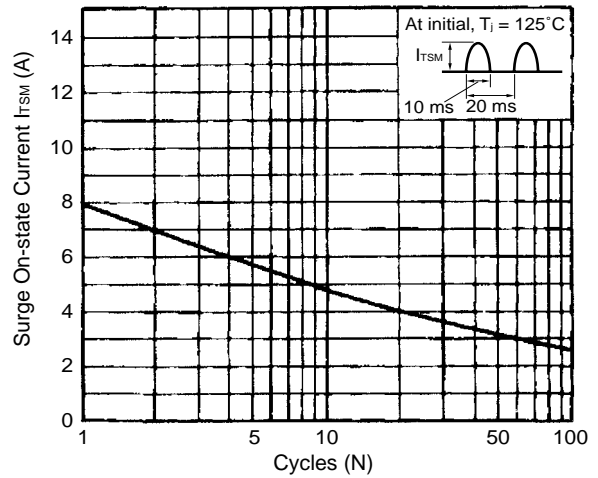

Figure 3. Gate Rating

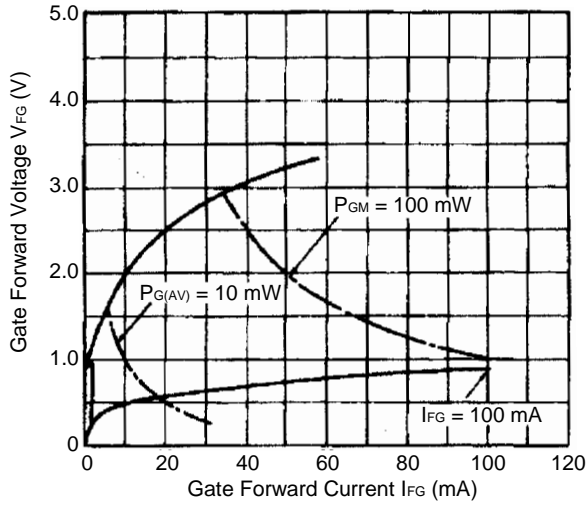

Figure 4. Example of Gate Characteristics

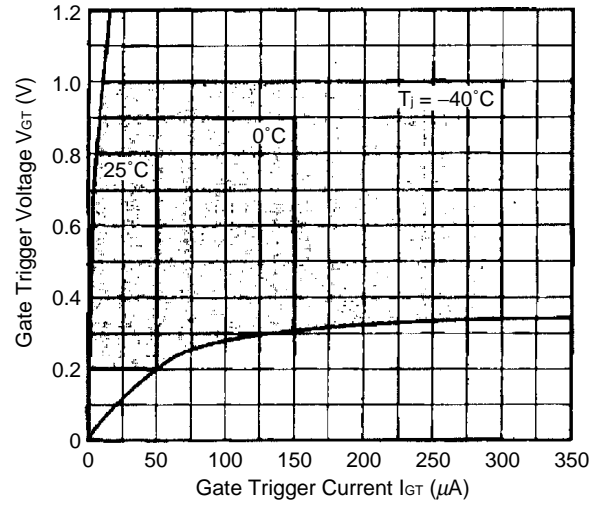

Figure 5. I_{GT} vs. T_A Example of Characteristics

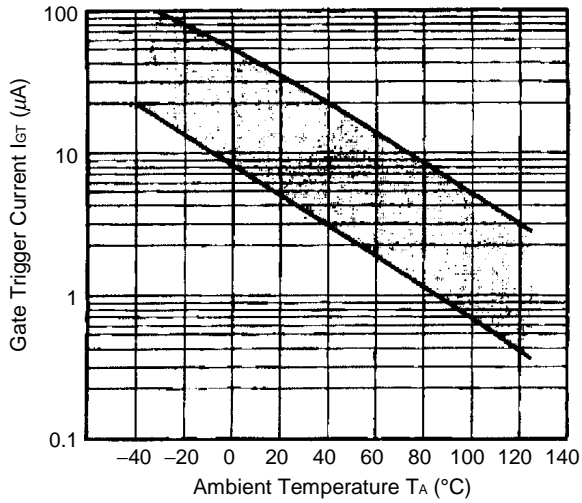

Figure 6. V_{GT} vs. T_A Example of Characteristics

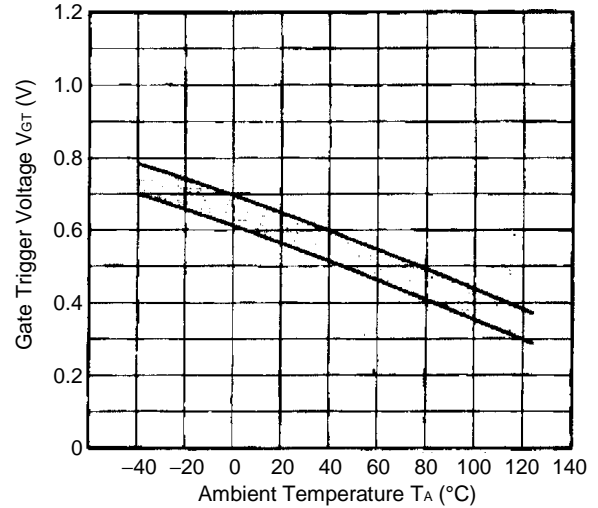

Figure 7. i_{GS} vs. τ Example of Characteristics

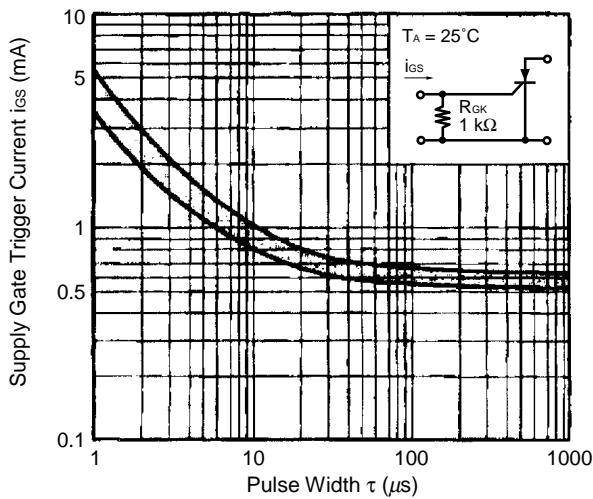

Figure 8. v_{GT} vs. τ Example of Characteristics

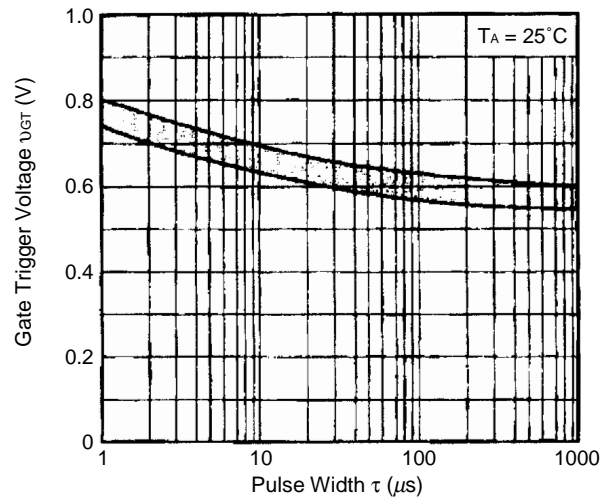

Figure 9. $P_{T(AV)}$ vs. $I_{T(AV)}$ Characteristics

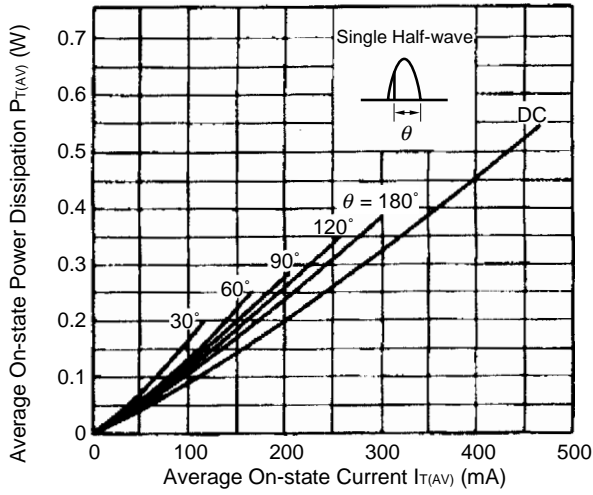

Figure 10. T_A vs. $I_{T(AV)}$ Characteristics

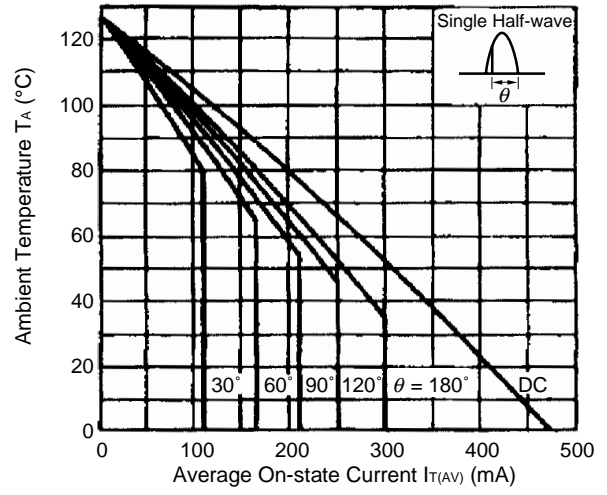

Figure 11. $P_{T(AV)}$ vs. $I_{T(AV)}$ Characteristics

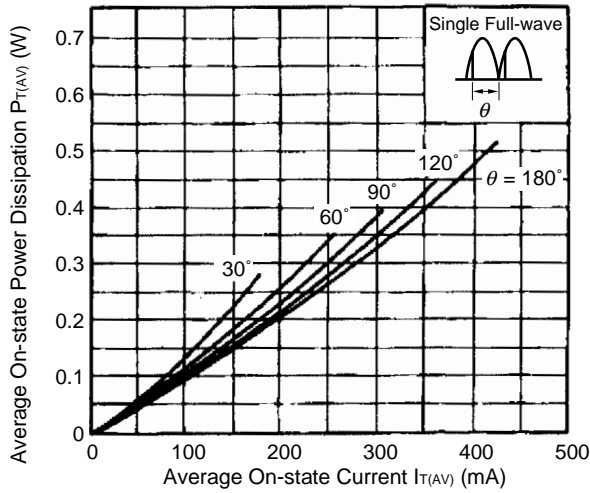

Figure 12. T_A vs. $I_{T(AV)}$ Characteristics

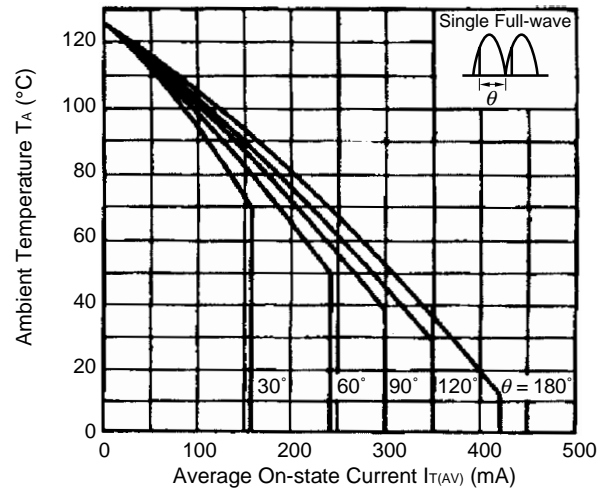

Figure 13. I_H vs. T_A Example of Characteristics

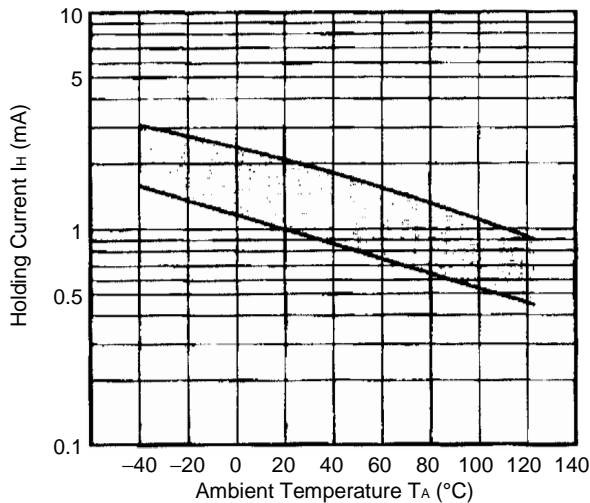
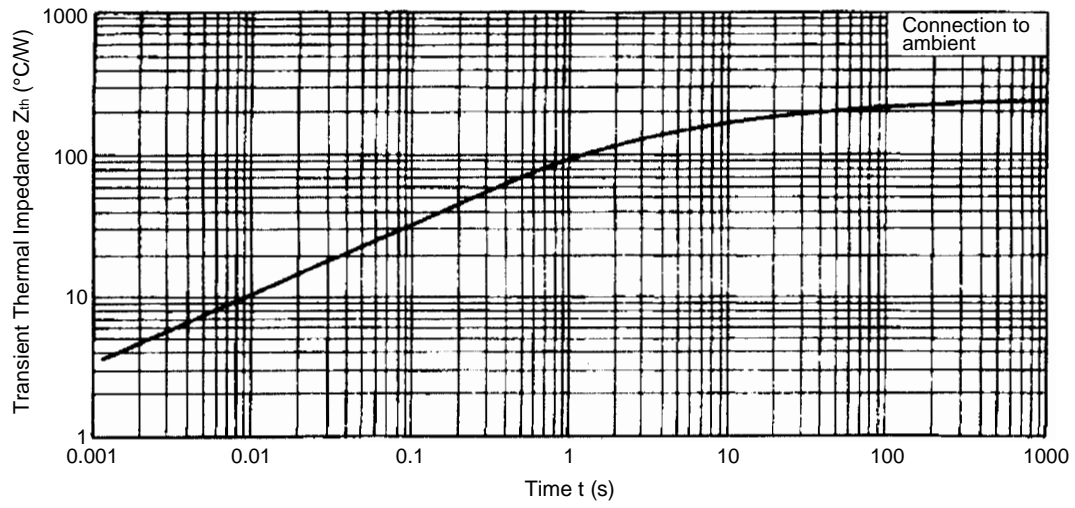

Figure 14. Z_{th} Characteristics



- **The information in this document is current as of February, 2003. The information is subject to change without notice. For actual design-in, refer to the latest publications of NEC Electronics data sheets or data books, etc., for the most up-to-date specifications of NEC Electronics products. Not all products and/or types are available in every country. Please check with an NEC Electronics sales representative for availability and additional information.**
- No part of this document may be copied or reproduced in any form or by any means without the prior written consent of NEC Electronics. NEC Electronics assumes no responsibility for any errors that may appear in this document.
- NEC Electronics does not assume any liability for infringement of patents, copyrights or other intellectual property rights of third parties by or arising from the use of NEC Electronics products listed in this document or any other liability arising from the use of such products. No license, express, implied or otherwise, is granted under any patents, copyrights or other intellectual property rights of NEC Electronics or others.
- Descriptions of circuits, software and other related information in this document are provided for illustrative purposes in semiconductor product operation and application examples. The incorporation of these circuits, software and information in the design of a customer's equipment shall be done under the full responsibility of the customer. NEC Electronics assumes no responsibility for any losses incurred by customers or third parties arising from the use of these circuits, software and information.
- While NEC Electronics endeavors to enhance the quality, reliability and safety of NEC Electronics products, customers agree and acknowledge that the possibility of defects thereof cannot be eliminated entirely. To minimize risks of damage to property or injury (including death) to persons arising from defects in NEC Electronics products, customers must incorporate sufficient safety measures in their design, such as redundancy, fire-containment and anti-failure features.
- NEC Electronics products are classified into the following three quality grades: "Standard", "Special" and "Specific".

The "Specific" quality grade applies only to NEC Electronics products developed based on a customer-designated "quality assurance program" for a specific application. The recommended applications of an NEC Electronics product depend on its quality grade, as indicated below. Customers must check the quality grade of each NEC Electronics product before using it in a particular application.

"Standard": Computers, office equipment, communications equipment, test and measurement equipment, audio and visual equipment, home electronic appliances, machine tools, personal electronic equipment and industrial robots.

"Special": Transportation equipment (automobiles, trains, ships, etc.), traffic control systems, anti-disaster systems, anti-crime systems, safety equipment and medical equipment (not specifically designed for life support).

"Specific": Aircraft, aerospace equipment, submersible repeaters, nuclear reactor control systems, life support systems and medical equipment for life support, etc.

The quality grade of NEC Electronics products is "Standard" unless otherwise expressly specified in NEC Electronics data sheets or data books, etc. If customers wish to use NEC Electronics products in applications not intended by NEC Electronics, they must contact an NEC Electronics sales representative in advance to determine NEC Electronics' willingness to support a given application.

(Note)

- (1) "NEC Electronics" as used in this statement means NEC Electronics Corporation and also includes its majority-owned subsidiaries.
- (2) "NEC Electronics products" means any product developed or manufactured by or for NEC Electronics (as defined above).