

# K Band High Power Amplifier

# TGA4502-SCC

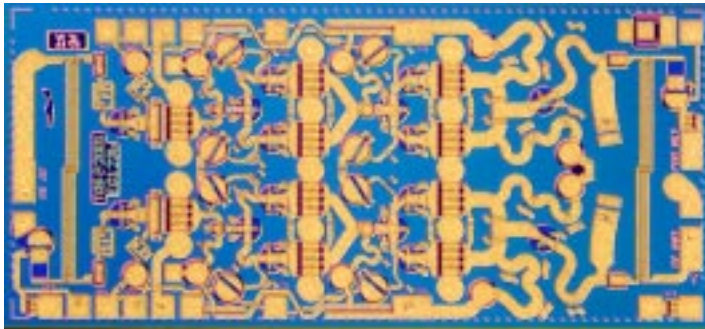

### Key Features

- 17-27 GHz Application Frequency Range
- 22 dB Nominal Gain
- 29 dBm Nominal P1dB
- 37dBm Nominal OTOI
- 15 dB Nominal Return Loss
- 0.25 um pHEMT 2MI Technology
- Bias 7V @ 760 mA
- Chip Dimensions 1.52 x 3.29 x .1mm

### Product Description

The TriQuint TGA4502-SCC is a compact High Power Amplifier MMIC for K-band applications. The part is designed using TriQuint's proven standard 0.25 um gate power pHEMT production process.

The TGA4502-SCC provides a nominal 29 dBm of output power at 1 dB gain compression from 17-27 GHz with a small signal gain of 22 dB.

The part is ideally suited for low cost emerging markets such as K-band Satellite Communications, Point-to-Point Radio, and Point-to-Multi Point Communications.

The TGA4502-SCC is 100% DC and RF tested on-wafer to ensure performance compliance.

### Primary Applications

- K Band Sat-Com
- Point-to-Point Radio
- Point-to-Multipoint Communications

### Fixtured Measured Performance

Bias Conditions:  $V_d = 7V$ ,  $I_d = 760mA$

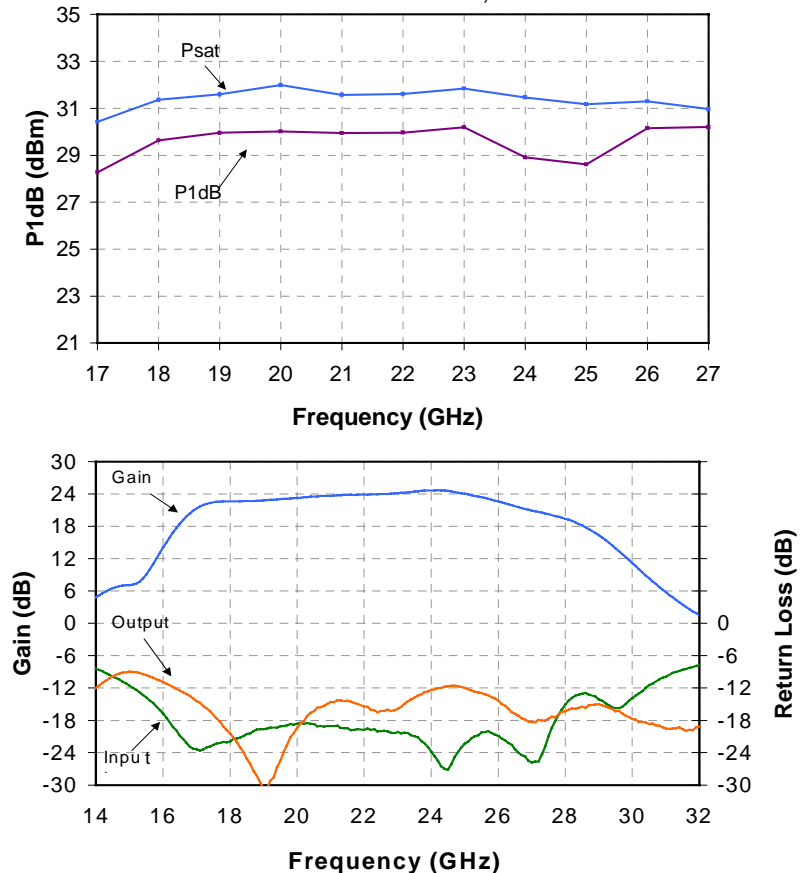

**TABLE I**  
**MAXIMUM RATINGS 1/**

| <b>SYMBOL</b>    | <b>PARAMETER</b>                  | <b>VALUE</b>  | <b>NOTES</b>          |
|------------------|-----------------------------------|---------------|-----------------------|
| V <sup>+</sup>   | Positive Supply Voltage           | 8 V           | <u>2/</u>             |
| V <sup>-</sup>   | Negative Supply Voltage Range     | -5V TO 0V     |                       |
| I <sup>+</sup>   | Positive Supply Current           | 880 mA        | <u>2/</u>             |
| I <sub>G</sub>   | Gate Supply Current               | 28 mA         |                       |
| P <sub>IN</sub>  | Input Continuous Wave Power       | 26 dBm        | <u>2/</u>             |
| P <sub>D</sub>   | Power Dissipation                 | 5.3 W         | <u>2/</u> , <u>3/</u> |
| T <sub>CH</sub>  | Operating Channel Temperature     | 150 °C        | <u>4/</u> , <u>5/</u> |
| T <sub>M</sub>   | Mounting Temperature (30 Seconds) | 320 °C        |                       |
| T <sub>STG</sub> | Storage Temperature               | -65 to 150 °C |                       |

- 1/ These ratings represent the maximum operable values for this device.
- 2/ Current is defined under no RF drive conditions. Under RF drive, the supply current may rise to 1100 mA without damage. Combinations of supply voltage, supply current, input power, and output power shall not exceed P<sub>D</sub>.
- 3/ When operated at this power dissipation with a base plate temperature of 70 °C, the median life is 1 E+6 hours.
- 4/ Junction operating temperature will directly affect the device median time to failure (T<sub>M</sub>). For maximum life, it is recommended that junction temperatures be maintained at the lowest possible levels.
- 5/ These ratings apply to each individual FET.

**TABLE II**  
**DC PROBE TEST**

 (T<sub>A</sub> = 25 °C, Nominal)

| SYMBOL                           | PARAMETER                     | MINIMUM | MAXIMUM | UNIT |
|----------------------------------|-------------------------------|---------|---------|------|
| I <sub>dss, Q1</sub>             | Saturated Drain Current       | 60      | 282     | mA   |
| G <sub>m, Q1</sub>               | Transconductance              | 132     | 318     | mS   |
| V <sub>p, Q1,2, 3-6, 7-10</sub>  | Pinch-off Voltage             | -1.5    | -0.5    | V    |
| V <sub>BVGD, Q1-10</sub>         | Breakdown Voltage Gate-Drain  | -30     | -13     | V    |
| V <sub>BVGS, Q1,2,3-6,7-10</sub> | Breakdown Voltage Gate-Source | -30     | -13     | V    |

Note: Q1 &amp; Q2 are 600 um FETs. Q3-6 &amp; Q7-10 are 2400 um FETs. Q1-10 is a 6000 um FET.

**TABLE III**  
**RF CHARACTERIZATION TABLE**

 (T<sub>A</sub> = 25 °C, Nominal)

 V<sub>d</sub> = 7V, I<sub>d</sub> = 760 mA

| SYMBOL           | PARAMETER                           | TEST CONDITION               | LIMITS  |         |         | UNITS |
|------------------|-------------------------------------|------------------------------|---------|---------|---------|-------|
|                  |                                     |                              | MINIMUM | TYPICAL | MAXIMUM |       |
| Gain             | Small Signal Gain                   | F = 17 – 18 GHz              | --      | 22      | --      | dB    |
|                  |                                     | F = 17.5, 18 GHz             | 17      | --      | --      |       |
|                  |                                     | F = 20, 22, 24 GHz           | 18      | 23      | --      |       |
|                  |                                     | F = 26.5 GHz                 | 17      | --      | --      |       |
|                  |                                     | F = 27 GHz                   | --      | 20      | --      |       |
| IRL              | Input Return Loss                   | F = 17 – 27 GHz              | --      | 20      | --      | dB    |
|                  |                                     | F = 17.5, 18, 20, 22, 24 GHz | --      | --      | 12      |       |
|                  |                                     | F = 26.5 GHz                 | --      | --      | 10      |       |
| ORL              | Output Return Loss                  | F = 17 – 27 GHz              | --      | 15      | --      | dB    |
|                  |                                     | F = 17.5, 18, 20, 22, 24 GHz | --      | --      | 12      |       |
|                  |                                     | F = 26.5 GHz                 | --      | --      | 10      |       |
| P <sub>1dB</sub> | Output Power @ 1dB Gain Compression | F = 17 – 27 GHz              | --      | 30      | --      | dBm   |
|                  |                                     | F = 18, 26.5 GHz             | 27      | --      | --      |       |
| OTOI *           | Output Third Order Intercept        | F = 17 – 27 GHz              | --      | 37      | --      | dBm   |
|                  |                                     | F = 18, 26 GHz               | 34.5    | --      | --      |       |

\* Pin/tone = -7dBm, Separation = 0.010 GHz

**TABLE IV**  
**THERMAL INFORMATION**

| Parameter  | Test Conditions                                      | T <sub>CH</sub><br>(°C) | R <sub>θJC</sub><br>(°C/W) | T <sub>M</sub><br>(HRS) |
|--|--|-------------------------|----------------------------|-------------------------|
| R <sub>θJC</sub> Thermal Resistance (channel to backside of carrier) | Vd = 7 V<br>Id = 760 mA<br>P <sub>diss</sub> = 5.3 W | 150                     | 15.1                       | 1 E+6                   |

Note: Assumes eutectic attach using 1.5 mil 80/20 AuSn mounted to a 20 mil CuMo Carrier at 70°C baseplate temperature. Worst case condition with no RF applied, 100% of DC power is dissipated.

**Measured Fixtured Data**  
 Bias Conditions:  $V_d = 7V$ ,  $I_d = 760mA$

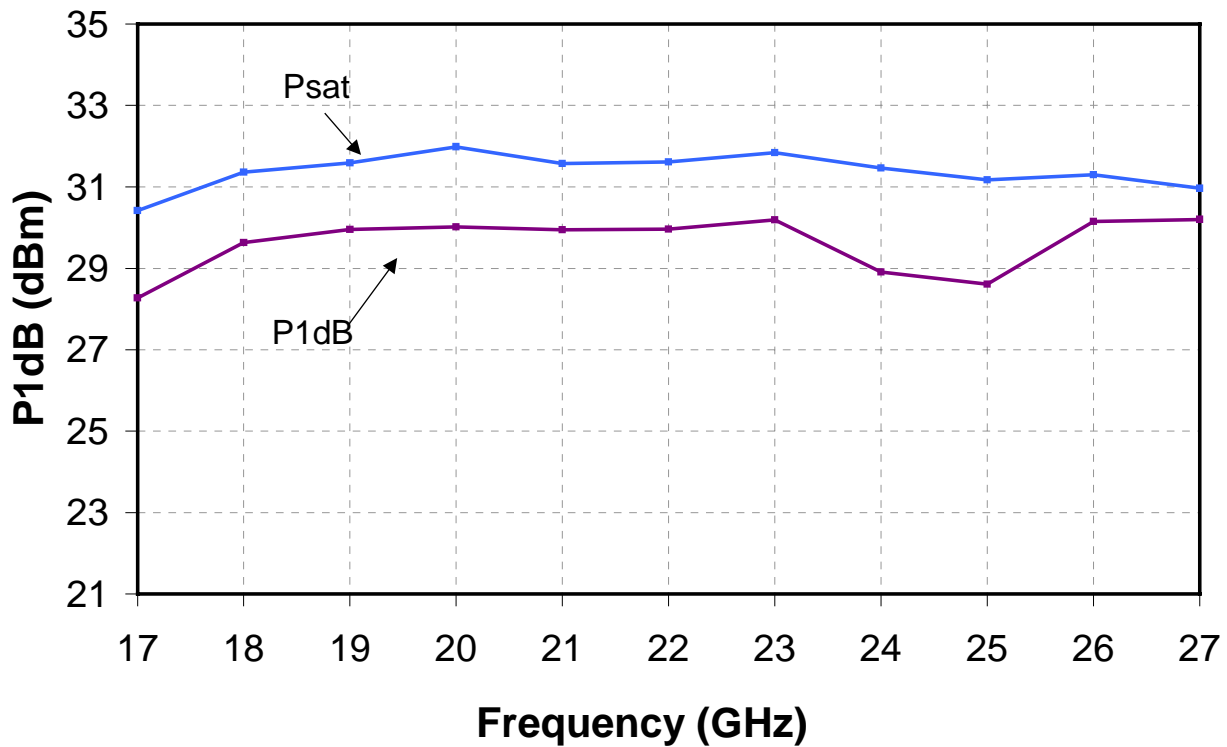
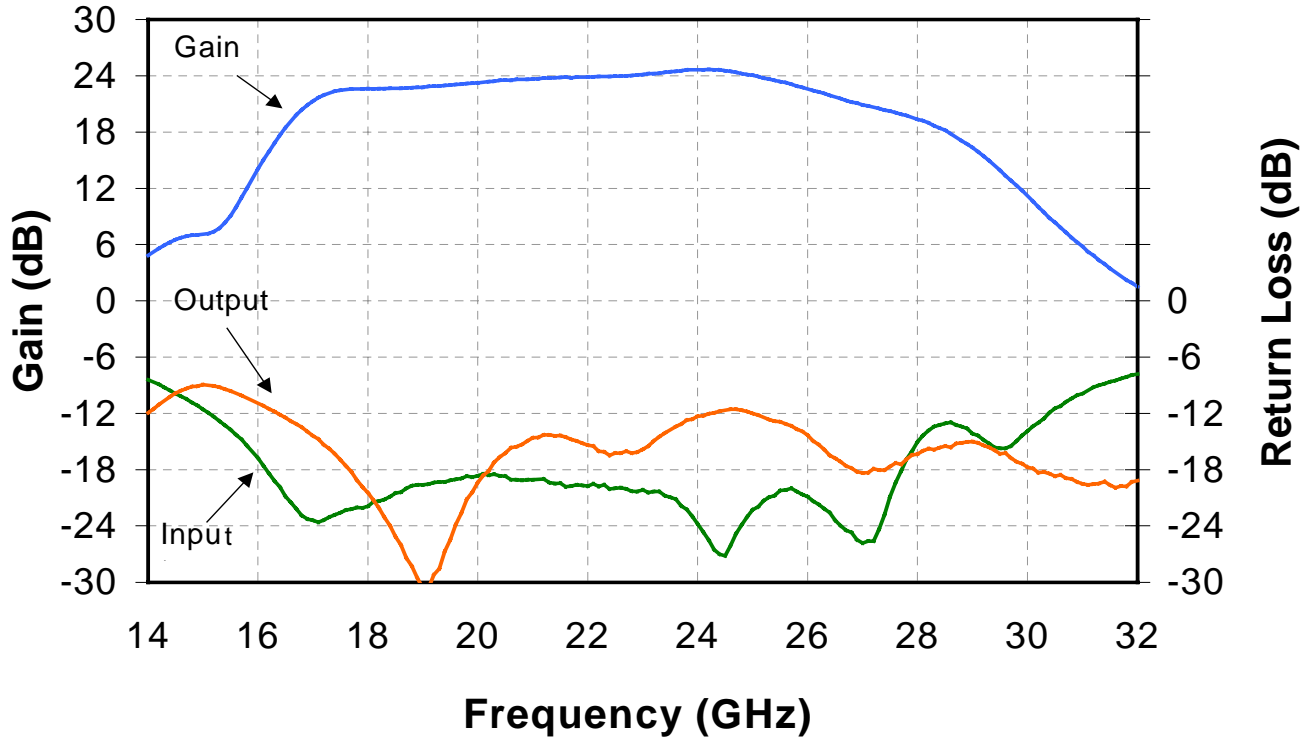

**Measured Fixtured Data**

Bias Conditions:  $V_d = 7V$ ,  $I_d = 760mA$

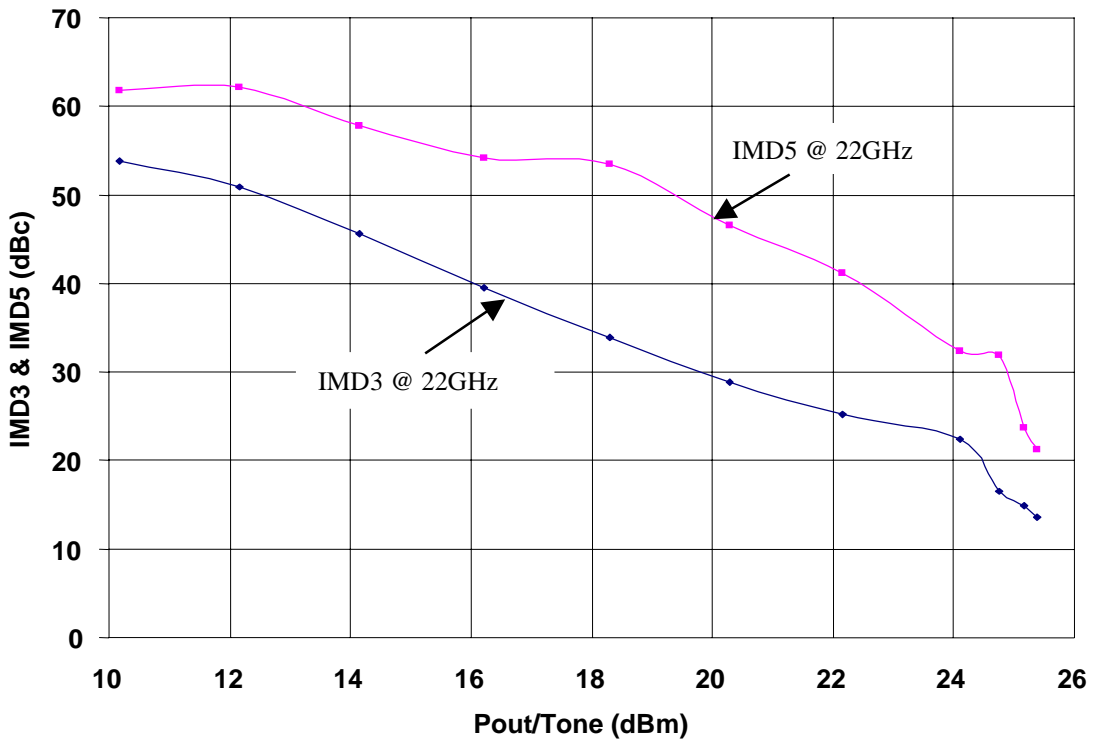
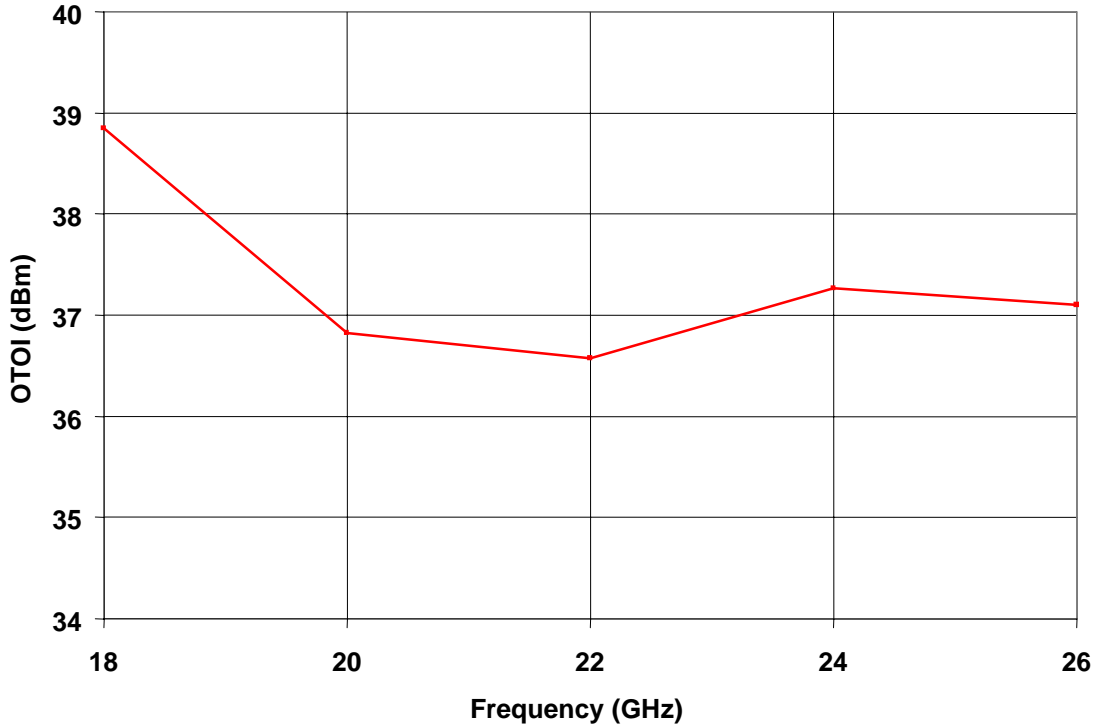

**Measured Fixtured Data**  
 Bias Conditions:  $V_d = 7V, I_d = 760mA$

At Frequency: 18GHz

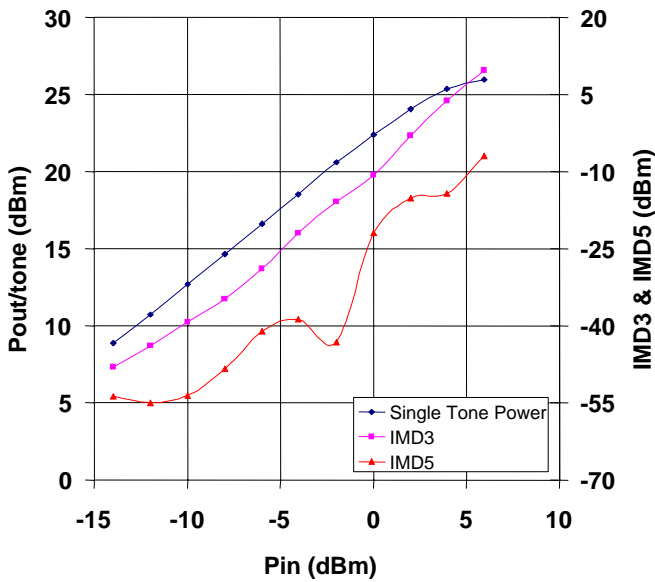

At Frequency: 20GHz

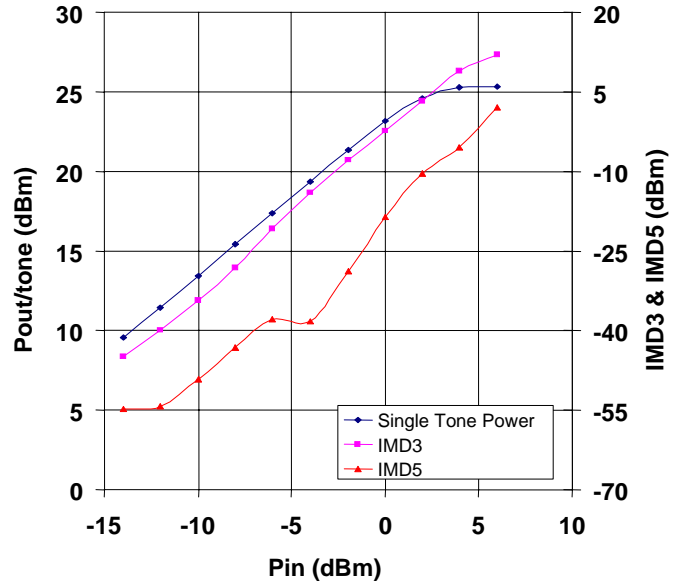

At Frequency: 24GHz

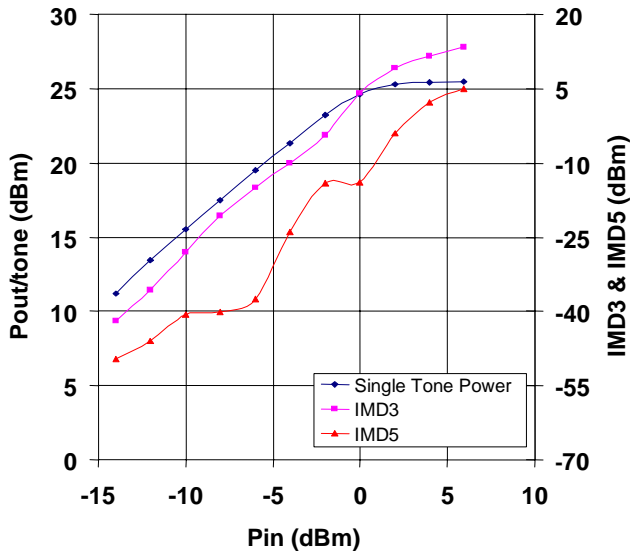

At Frequency: 26GHz

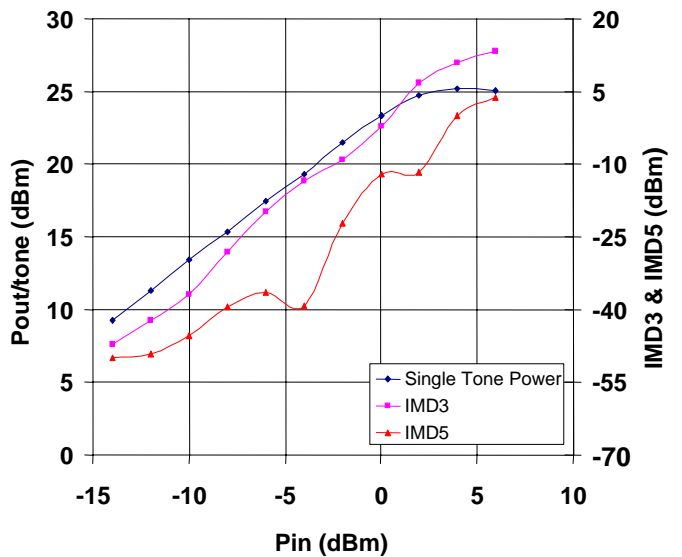

Recommended Assembly Diagram

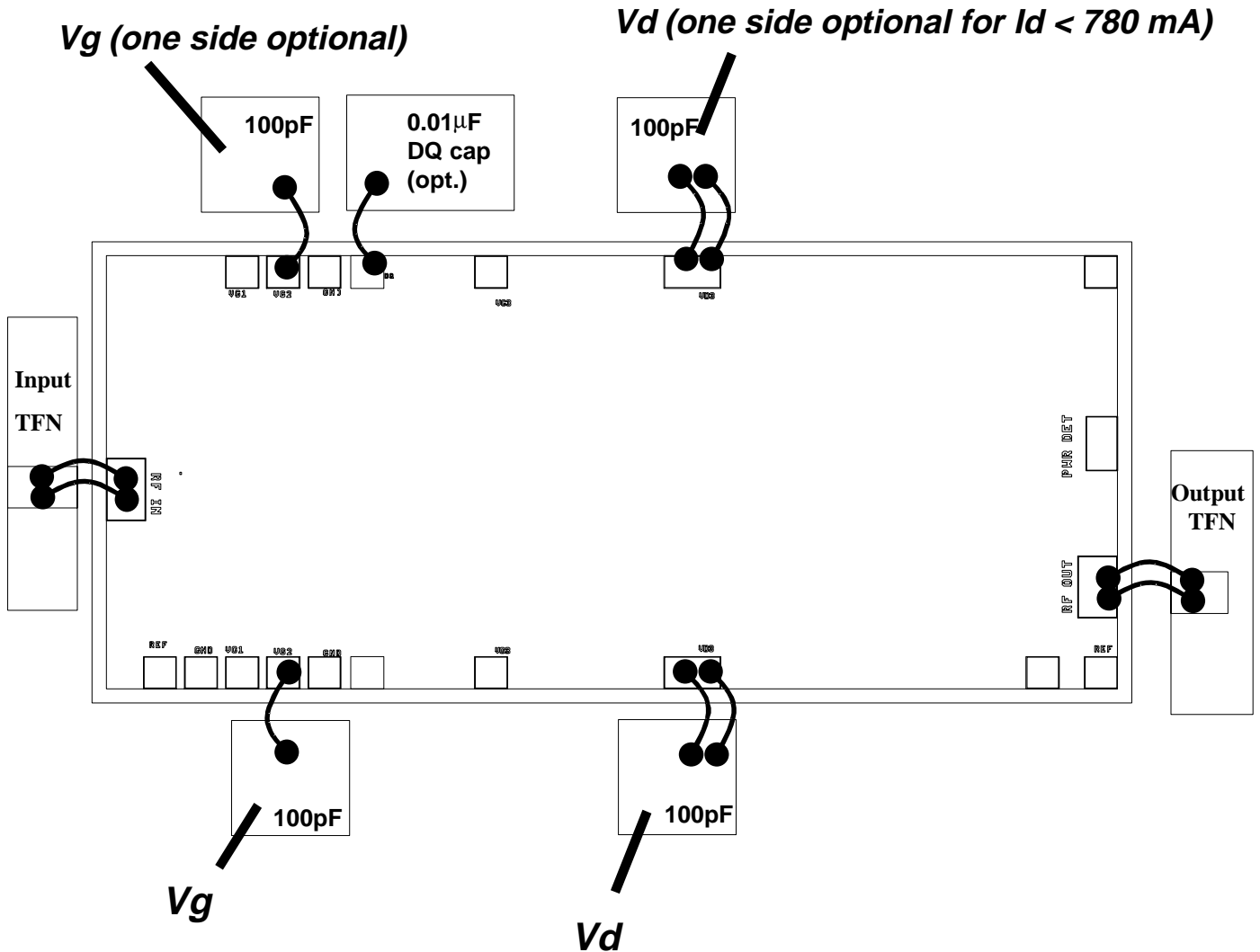

Notes:

1. Connection to power det, ref diode not shown.
2. 0.1µF cap on gate, drain lines not shown but required.
3. For high power operation, gate voltage is recommended from both sides.
4. Drain voltage is required from both sides for  $I_d > 780\text{mA}$ .

*GaAs MMIC devices are susceptible to damage from Electrostatic Discharge. Proper precautions should be observed during handling, assembly and test.*



**TGA4502 built-in power detector**

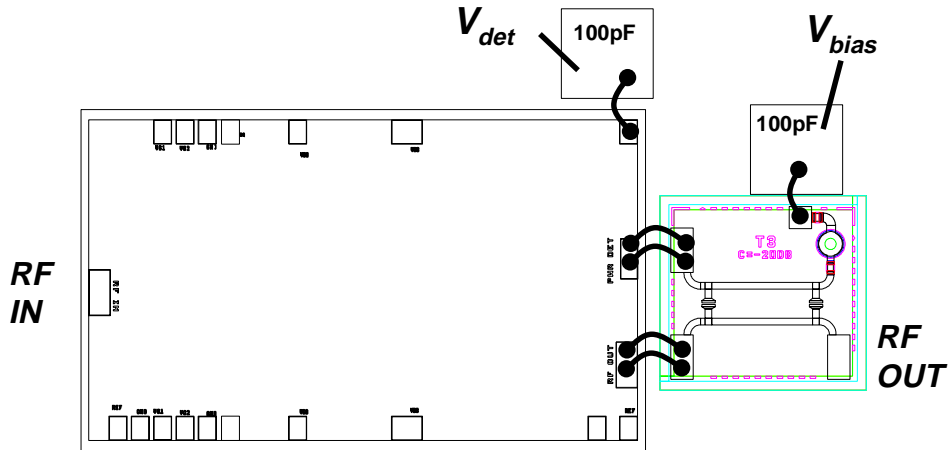

**TGA4502 with external test coupler  
(amplifier bias connections not shown)**

**On-chip diode functions as envelope detector  
External coupler and DC bias required**

TGA4502 measured detector voltage offset vs output power  
with 20dB coupler:  $V_b=0.8V$ ,  $f = 20GHz$ , Coupler loss is  
uncalibrated,  $10K\Omega$  load

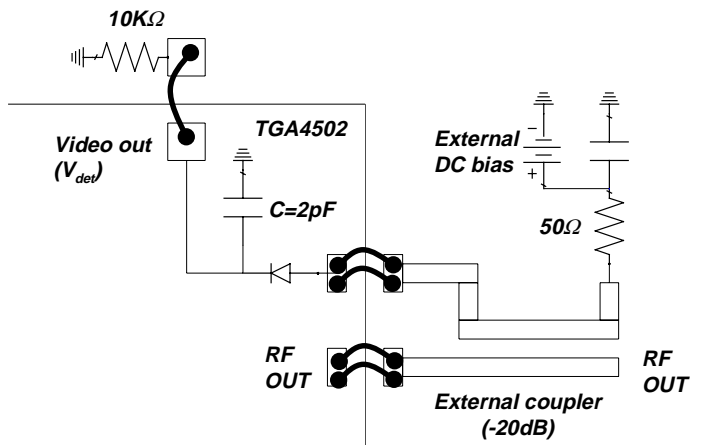
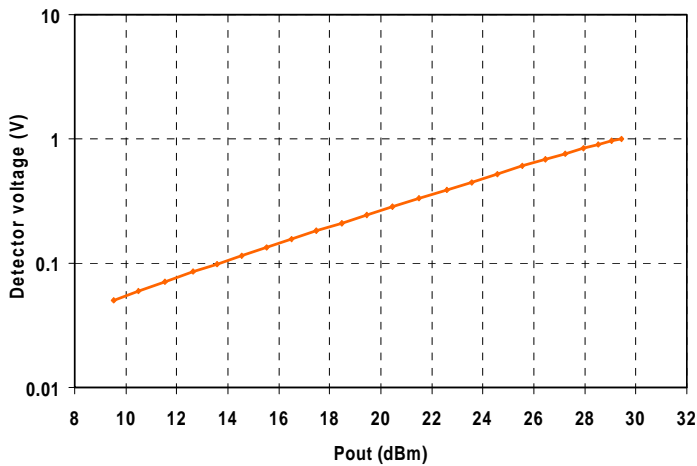

**Mechanical Drawing**

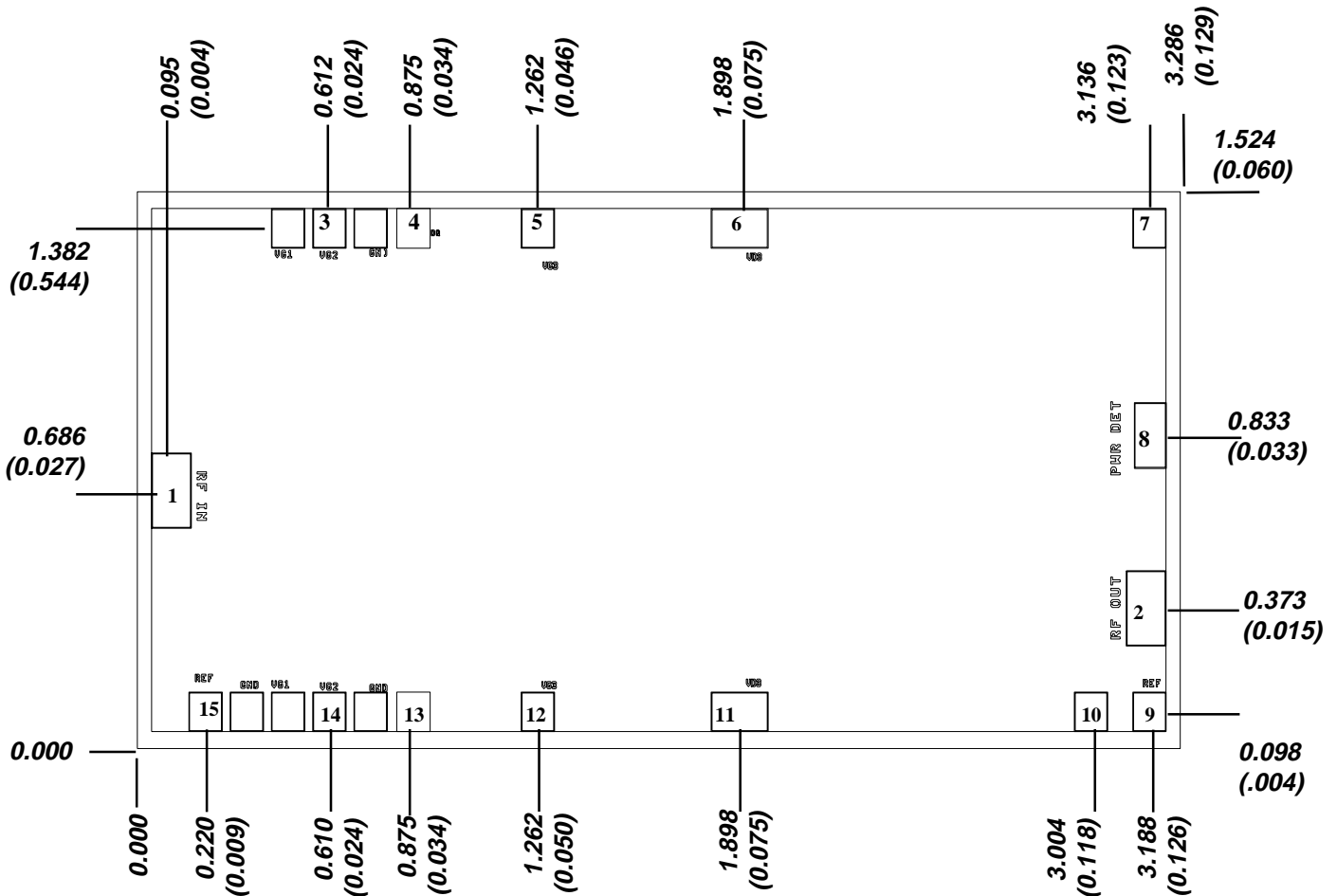

Units: Millimeters (inches)  
 Thickness: 0.100 (0.004) (reference only)  
 Chip edge to bond pad dimensions are shown to center of bond pad  
 Chip size tolerance +/- 0.051 (0.002)  
 GND IS BACKSIDE OF MMIC

|             |             |                               |              |      |                               |
|-------------|-------------|-------------------------------|--------------|------|-------------------------------|
| Bond pad #1 | (RF Input)  | 0.200 x 0.100 (0.008 x 0.004) | Bond pad #9  | REF2 | 0.100 x 0.100 (0.004 x 0.004) |
| Bond pad #2 | (RF Output) | 0.200 x 0.100 (0.008 x 0.004) | Bond pad #10 | REF1 | 0.100 x 0.100 (0.004 x 0.004) |
| Bond pad #3 | VG2         | 0.100 x 0.100 (0.004 x 0.004) | Bond pad #11 | VD3  | 0.180 x 0.100 (0.007 x 0.004) |
| Bond pad #4 | DQ          | 0.100 x 0.100 (0.004 x 0.004) | Bond pad #12 | VG3  | 0.100 x 0.100 (0.004 x 0.004) |
| Bond pad #5 | VG3         | 0.100 x 0.100 (0.004 x 0.004) | Bond pad #13 | DQ   | 0.100 x 0.100 (0.004 x 0.004) |
| Bond pad #6 | VD3         | 0.180 x 0.100 (0.007 x 0.004) | Bond pad #14 | VG2  | 0.100 x 0.100 (0.004 x 0.004) |
| Bond pad #7 | DET OUT     | 0.100 x 0.100 (0.004 x 0.004) | Bond pad #15 | REF3 | 0.100 x 0.100 (0.004 x 0.004) |
| Bond pad #8 | PWR DET     | 0.175 x 0.100 (0.007 x 0.004) |              |      |                               |

**GaAs MMIC devices are susceptible to damage from Electrostatic Discharge. Proper precautions should be observed during handling, assembly and test.**

## **Assembly Process Notes**

Reflow process assembly notes:

- Use AuSn (80/20) solder with limited exposure to temperatures at or above 300°C (for 30 sec max).
- An alloy station or conveyor furnace with reducing atmosphere should be used.
- No fluxes should be utilized.
- Coefficient of thermal expansion matching is critical for long-term reliability.
- Devices must be stored in a dry nitrogen atmosphere.

Component placement and adhesive attachment assembly notes:

- Vacuum pencils and/or vacuum collets are the preferred method of pick up.
- Air bridges must be avoided during placement.
- The force impact is critical during auto placement.
- Organic attachment can be used in low-power applications.
- Curing should be done in a convection oven; proper exhaust is a safety concern.
- Microwave or radiant curing should not be used because of differential heating.
- Coefficient of thermal expansion matching is critical.

Interconnect process assembly notes:

- Thermosonic ball bonding is the preferred interconnect technique.
- Force, time, and ultrasonics are critical parameters.
- Aluminum wire should not be used.
- Discrete FET devices with small pad sizes should be bonded with 0.0007-inch wire.
- Maximum stage temperature is 200°C.

***GaAs MMIC devices are susceptible to damage from Electrostatic Discharge. Proper precautions should be observed during handling, assembly and test.***

**Die are shipped in H20-074149 waffle packs.**