

**GaAs SP6T Switch, Absorptive, Single Supply
DC - 4.0 GHz**

**SW90-0004A
V7**

Features

- Operates DC - 4 GHz on Single Supply
- ASIC TTL / CMOS Driver
- Leadless 4 x 7 mm Chip Scale Plastic Package
- Low DC Power Consumption
- 50 Ohm Nominal Impedance
- Test Boards are Available
- Tape and Reel are Available

Description

M/A-COM's SW90-0004A is a SP6T absorptive pHEMT switch with integral TTL driver. This device is in an MLP plastic surface mount package. This switch offers excellent broadband performance and repeatability from DC to 4 GHz, while maintaining low DC power dissipation. The SW90-0004A is ideally suited for wireless infrastructure applications.

Ordering Information

Part Number	Package
SW90-0004A	Bulk Packaging
SW90-0004ATR	1000 piece reel
SW90-0004A-TB	Units Mounted on Test Board

Note: Reference Application Note M513 for reel size information.

Absolute Maximum Ratings ^{1,2}

Parameter	Absolute Maximum
Max. Input Power 0.05 GHz 0.5 - 4.0 GHz	+27 dBm +34 dBm
Bias Voltages V _{CC} Control Voltage ³	+5.5V -0.5V to V _{CC} +0.5V
Operating Temperature	-40°C to +85°C
Storage Temperature	-65°C to +125°C

1. Operation of this device above any one of these parameters may cause permanent damage.
2. When the RF input is applied to the terminated port, the absolute maximum power is +30 dBm.
3. Standard CMOS TTL interface, latch-up will occur if logic signal is applied prior to power supply.

Functional Schematic

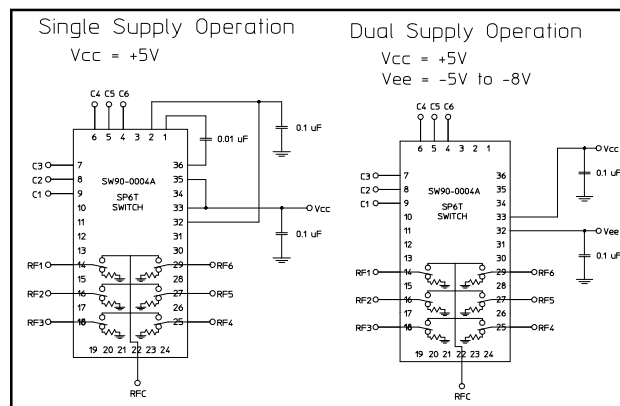

Pin Configuration ^{4,5,6}

Pin No.	Function	Pin No.	Function
1	CP2	19	GND
2	V _{EE}	20	NC
3	NC	21	GND
4	C6	22	RFC
5	C5	23	GND
6	C4	24	GND
7	C3	25	RF4
8	C2	26	GND
9	C1	27	RF5
10	NC	28	GND
11	GND	29	RF6
12	NC	30	GND
13	GND	31	NC
14	RF1	32	V _{EE}
15	GND	33	V _{CC}
16	RF2	34	NC
17	GND	35	V _{CC}
18	RF3	36	CP1

4. NC = No Connection
5. For single supply operation VEE is internally generated and must remain isolated from external power supplies. Generated noise is typical of switching DC-DC Converters.
6. Connections and external components shown in functional schematic are required. 0.1µF Capacitors need to be located near pins 32 & 33.

**GaAs SP6T Switch, Absorptive, Single Supply
DC - 4.0 GHz**

**SW90-0004A
V7**

Electrical Specifications: T_A = 25°C

Parameter	Test Conditions	Frequency	Units	Min.	Typ.	Max.
Insertion Loss	RFC-RF1, 2, 3, 4, 5, 6	DC - 3.0 GHz	dB	—	—	2.1
		3.0 - 4.0 GHz	dB	—	—	2.4
Isolation	—	DC - 4.0 GHz	dB	25	—	—
VSWR	On (RFC, RF1-RF6) Logic per Truth Table Off (RF1-RF6) Logic per Truth Table	DC - 4.0 GHz	Ratio	—	—	2.0:1
		DC - 4.0 GHz	Ratio	—	—	2.0:1
1 dB Compression	— —	50 MHz	dBm	—	15	—
		0.5 - 4.0 GHz	dBm	—	27	—
Input IP ₃	Two-tone inputs up to +5 dBm	50 MHz 0.5-4.0 GHz	dBm dBm	— —	30 40	— —
Switching Speed	Ton (50% Control to 10% RF)		nS	—	20	—
	Toff (50% Control to 90% RF)		nS	—	15	—
	Trise (10% to 90% RF)		nS	—	5	—
	Tfall (90% to 10% RF)		nS	—	2	—
V _{cc}	—	—	V	4.5	5.0	5.5
Logic "0"	Sink Current is 20 µA max.	—	V	0.0	—	0.8
Logic "1"	Source Current is 20 µA max.	—	V	2.0	—	5.0
I _{cc} ⁷	V _{cc} min to max, Logic "0" or "1"	—	mA	—	5	8
Turn-on Current ⁸	For guaranteed start-up	—	mA	—	—	125
Switching Noise	Generated from DC-DC Converter with recommended capacitors	3.5 MHz	dBm	—	-93	—
Thermal Resistance θ _{jc}	—	—	°C/W	—	15	—

7. During turn-on, the device requires an initial start up current (I_{cc}) specified as "Turn-on Current". Once operational, I_{cc} will drop to the specified levels. This is not applicable to dual supply operation.

8. The DC-DC converter is guaranteed to start in 100 µs as long as the power supplies have the maximum turn-on current available for start-up.

Truth Table

Control Inputs "0" is TTL Low, "1" is TTL High						Condition of Switch RF Common to Each RF Port					
C1	C2	C3	C4	C5	C6	RF1	RF2	RF3	RF4	RF5	RF6
1	0	0	0	0	0	On	Off	Off	Off	Off	Off
0	1	0	0	0	0	Off	On	Off	Off	Off	Off
0	0	1	0	0	0	Off	Off	On	Off	Off	Off
0	0	0	1	0	0	Off	Off	Off	On	Off	Off
0	0	0	0	1	0	Off	Off	Off	Off	On	Off
0	0	0	0	0	1	Off	Off	Off	Off	Off	On

**GaAs SP6T Switch, Absorptive, Single Supply
DC - 4.0 GHz**

**SW90-0004A
V7**

Typical Performance Curves

Insertion Loss vs. Frequency

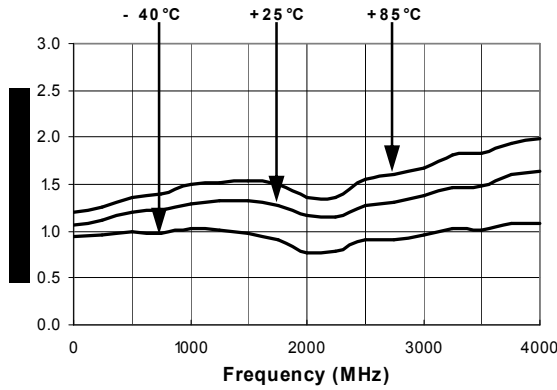

Isolation (dB) vs. Frequency

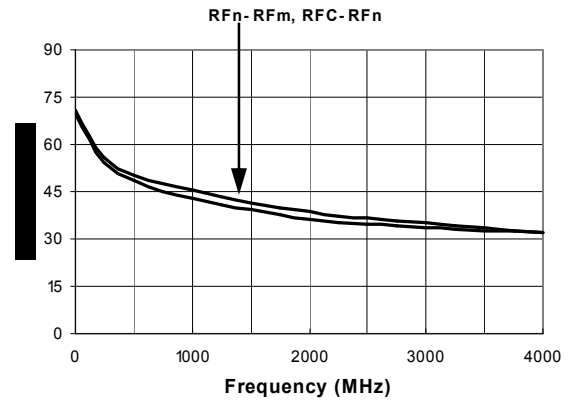

On VSWR vs. Frequency

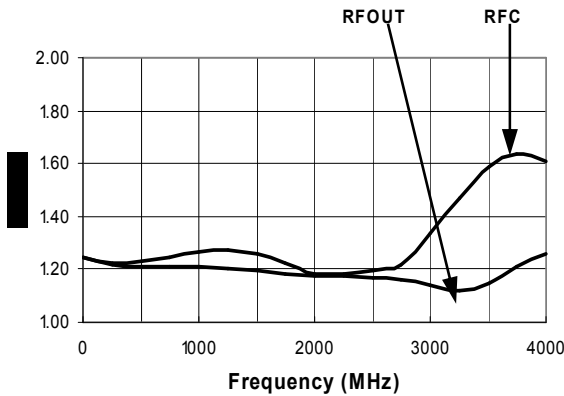

VSWR (Terminations) vs. Frequency

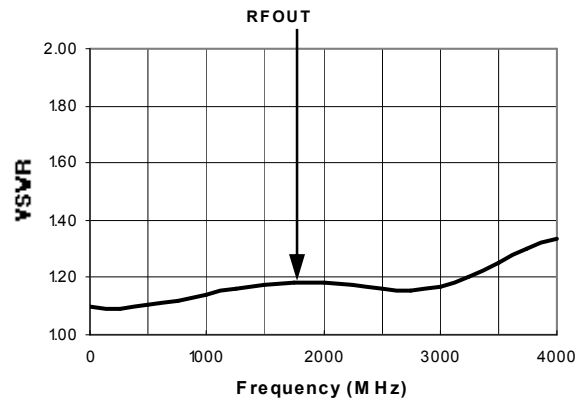

IP3 Results ¹⁰

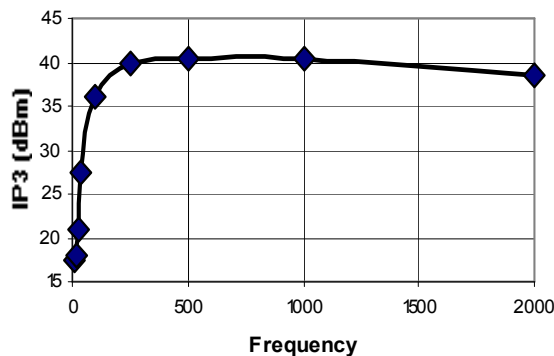

10. All testing done with the second tone 5 MHz above the frequency on the plot, except for the 10 MHz point, where the second tone is at 11 MHz. Both tones are +5 dBm.

**GaAs SP6T Switch, Absorptive, Single Supply
DC - 4.0 GHz**

**SW90-0004A
V7**

Recommended PCB Layout ⁹

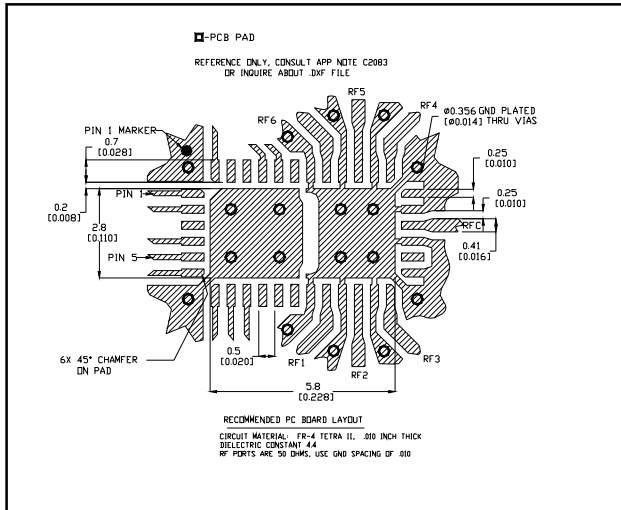

9. Application Note C2083 is available on line at www.macom.com

CSP-2

