

International  
**IOR** Rectifier

**MUR2020CTPbF**

## Ultrafast Rectifier

### Features

- Ultrafast Recovery Time
- Low Forward Voltage Drop
- Low Leakage Current
- 175°C Operating Junction Temperature
- Lead-Free ("PbF" suffix)

$$t_{rr} = 25\text{ns}$$

$$I_{F(AV)} = 20\text{Amp}$$

$$V_R = 200\text{V}$$

### Description/ Applications

International Rectifier's MUR.. series are the state of the art Ultra fast recovery rectifiers specifically designed with optimized performance of forward voltage drop and ultra fast recovery time.

The planar structure and the platinum doped life time control, guarantee the best overall performance, ruggedness and reliability characteristics.

These devices are intended for use in the output rectification stage of SMPS, UPS, DC-DC converters as well as free-wheeling diode in low voltage inverters and chopper motor drives.

Their extremely optimized stored charge and low recovery current minimize the switching losses and reduce over dissipation in the switching element and snubbers.

### Absolute Maximum Ratings

Parameters	Max	Units
$V_{RRM}$ Peak Repetitive Peak Reverse Voltage	200	V
$I_{F(AV)}$ Average Rectified Forward Current	10	A
Per Leg		
Total Device, (Rated $V_R$ ), $T_C = 145^\circ\text{C}$	20	
Total Device		
$I_{FSM}$ Non Repetitive Peak Surge Current	100	
Per Leg		
$I_{FM}$ Peak Repetitive Forward Current	20	
Per Leg		
(Rated $V_R$ , Square wave, 20 KHz), $T_C = 145^\circ\text{C}$		
$T_J, T_{STG}$ Operating Junction and Storage Temperatures	-65 to 175	$^\circ\text{C}$

## Case Styles

MUR2020CTPbF



TO-220AB

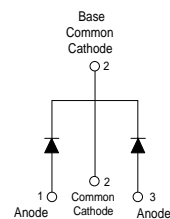

**Electrical Characteristics @ T<sub>J</sub> = 25°C (unless otherwise specified)**

Parameters	Min	Typ	Max	Units	Test Conditions
V <sub>BR</sub> , V <sub>r</sub> Breakdown Voltage, Blocking Voltage	200	-	-	V	I <sub>R</sub> = 100μA
V <sub>F</sub> Forward Voltage	-	-	0.85	V	I <sub>F</sub> = 8A, T <sub>J</sub> = 125°C
	-	-	1.15	V	I <sub>F</sub> = 16A, T <sub>J</sub> = 25°C
	-	-	1.05	V	I <sub>F</sub> = 16A, T <sub>J</sub> = 125°C
I <sub>R</sub> Reverse Leakage Current	-	-	15	μA	V <sub>R</sub> = V <sub>R</sub> Rated
	-	-	250	μA	T <sub>J</sub> = 150°C, V <sub>R</sub> = V <sub>R</sub> Rated
C <sub>T</sub> Junction Capacitance	-	55	-	pF	V <sub>R</sub> = 200V
L <sub>S</sub> Series Inductance	-	8.0	-	nH	Measured lead to lead 5mm from package body

**Dynamic Recovery Characteristics @ T<sub>J</sub> = 25°C (unless otherwise specified)**

Parameters	Min	Typ	Max	Units	Test Conditions	
t <sub>rr</sub> Reverse Recovery Time	-	-	35	ns	I <sub>F</sub> = 1.0A, di <sub>F</sub> /dt = 50A/μs, V <sub>R</sub> = 30V	
	-	-	25		I <sub>F</sub> = 0.5A, I <sub>R</sub> = 1.0A, I <sub>REC</sub> = 0.25A	
	-	21	-	A	T <sub>J</sub> = 25°C	
	-	35	-		T <sub>J</sub> = 125°C	
I <sub>RRM</sub> Peak Recovery Current	-	1.9	-	T <sub>J</sub> = 25°C	I <sub>F</sub> = 10A V <sub>R</sub> = 160V di <sub>F</sub> /dt = 200A/μs	
	-	4.8	-	T <sub>J</sub> = 125°C		
Q <sub>rr</sub> Reverse Recovery Charge	-	25	-	nC		T <sub>J</sub> = 25°C
	-	-	78	-		T <sub>J</sub> = 125°C

**Thermal - Mechanical Characteristics**

Parameters	Min	Typ	Max	Units
T <sub>J</sub> Max. Junction Temperature Range	- 65	-	175	°C
T <sub>Stg</sub> Max. Storage Temperature Range	- 65	-	175	
R <sub>thJC</sub> Thermal Resistance, Junction to Case Per Leg	-	-	2.5	°C/W
R <sub>thJA</sub> Thermal Resistance, Junction to Ambient Per Leg	-	-	50	
R <sub>thCS</sub> <sup>①</sup> Thermal Resistance, Case to Heatsink	-	0.5	-	
Wt Weight	-	2.0	-	g
	-	0.07	-	(oz)
Mounting Torque	6.0	-	12	Kg-cm
	5.0	-	10	lbf.in
Marking Device	MUR2020CT			

① Mounting Surface, Flat, Smooth and Greased

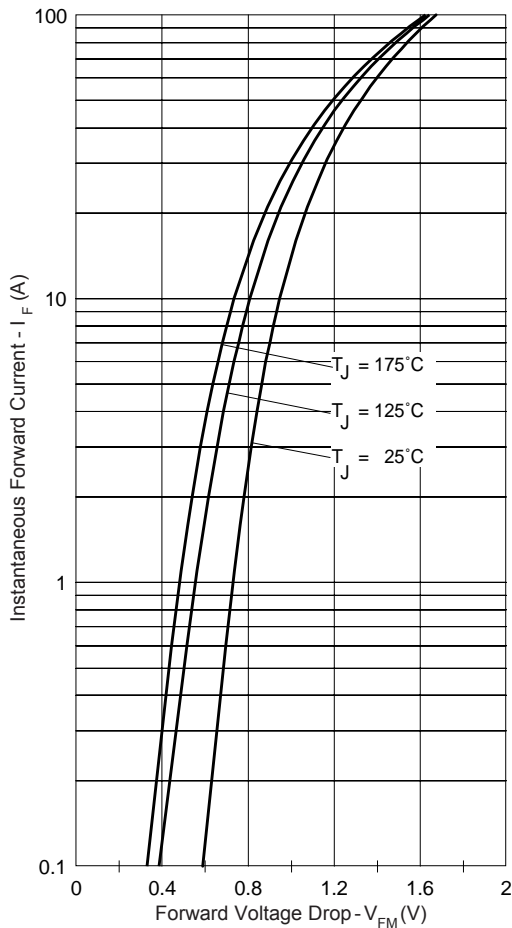

Fig. 1 - Typical Forward Voltage Drop Characteristics

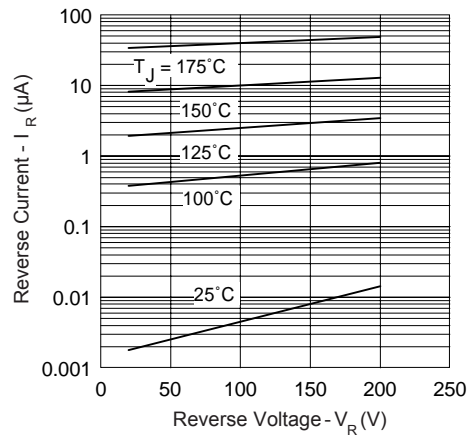

Fig. 2 - Typical Values Of Reverse Current Vs. Reverse Voltage

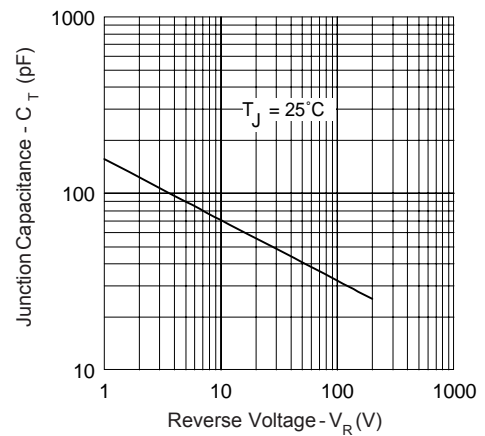

Fig. 3 - Typical Junction Capacitance Vs. Reverse Voltage

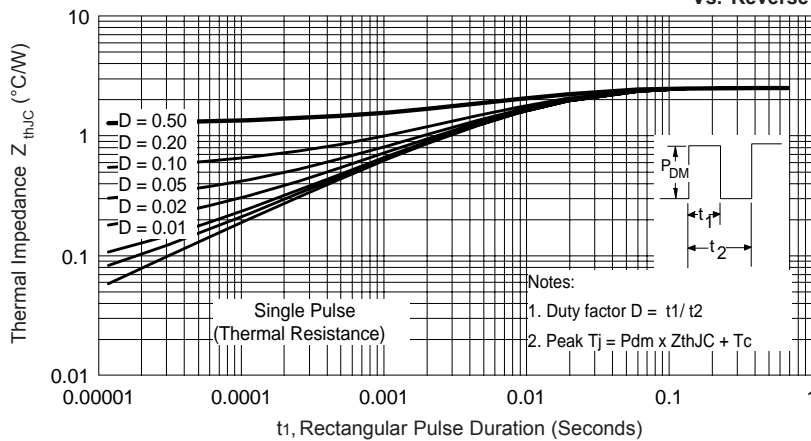

Fig. 4 - Max. Thermal Impedance  $Z_{thJC}$  Characteristics

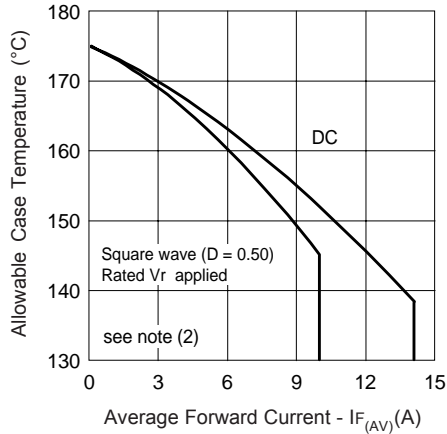

Fig. 5 - Max. Allowable Case Temperature Vs. Average Forward Current

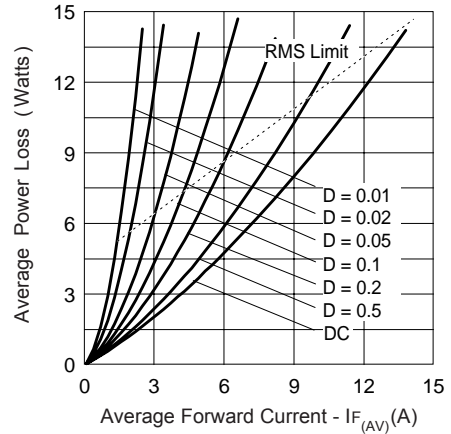

Fig. 6 - Forward Power Loss Characteristics

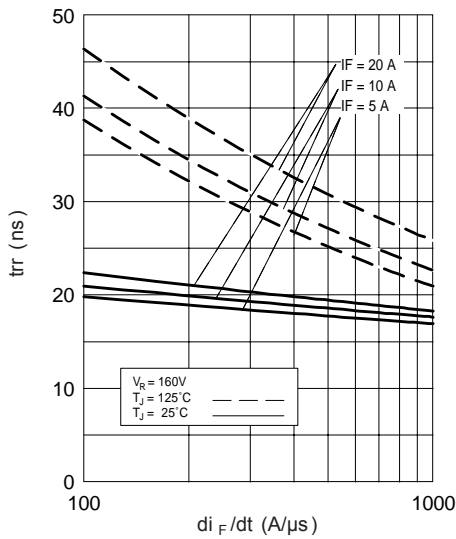

Fig. 7 - Typical Reverse Recovery vs.  $di_F/dt$

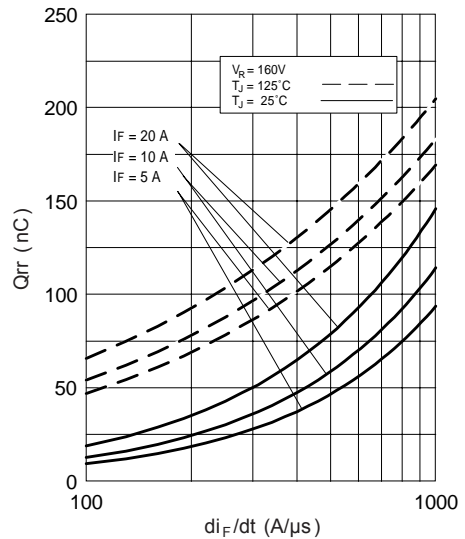

Fig. 8 - Typical Stored Charge vs.  $di_F/dt$

(2) Formula used:  $T_C = T_J - (Pd + Pd_{REV}) \times R_{thJC}$ ;  
 $Pd = \text{Forward Power Loss} = I_{F(AV)} \times V_{FM} @ (I_{F(AV)}/D)$  (see Fig. 6);  
 $Pd_{REV} = \text{Inverse Power Loss} = V_{R1} \times I_R (1-D); I_R @ V_{R1} = \text{rated } V_R$

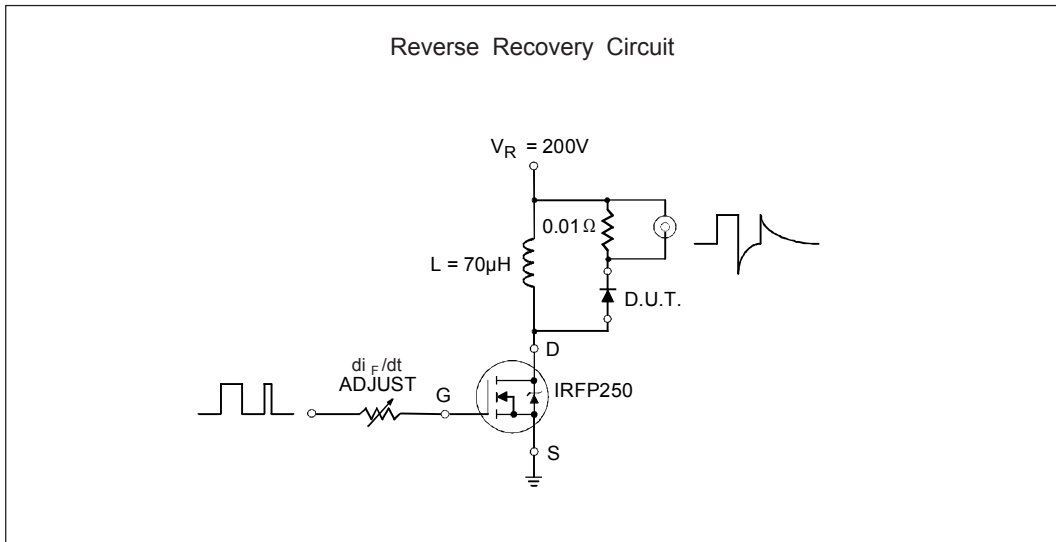

Fig. 9- Reverse Recovery Parameter Test Circuit

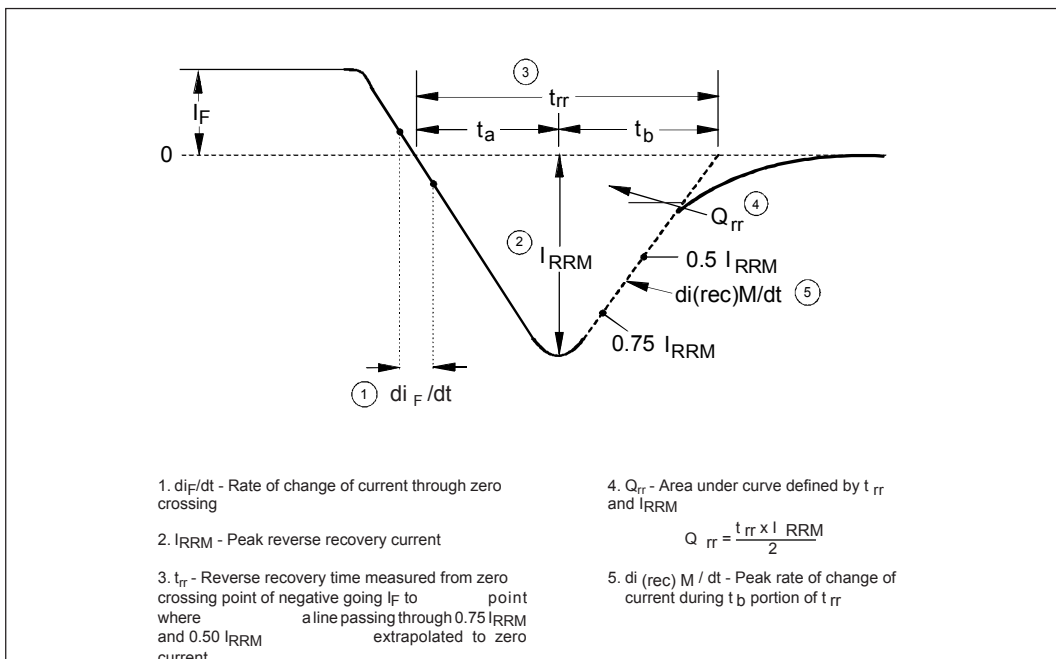
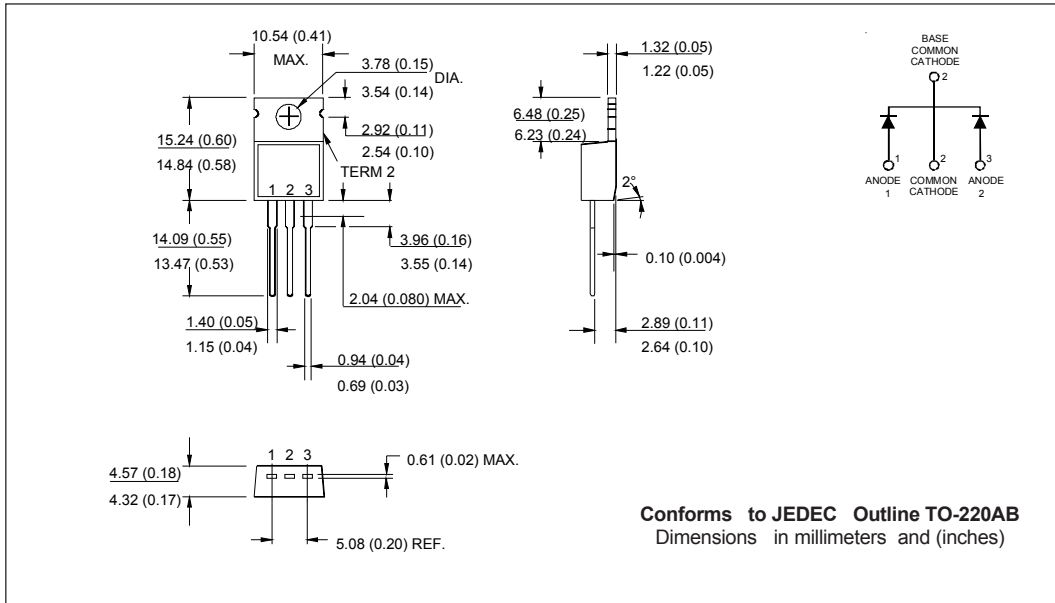
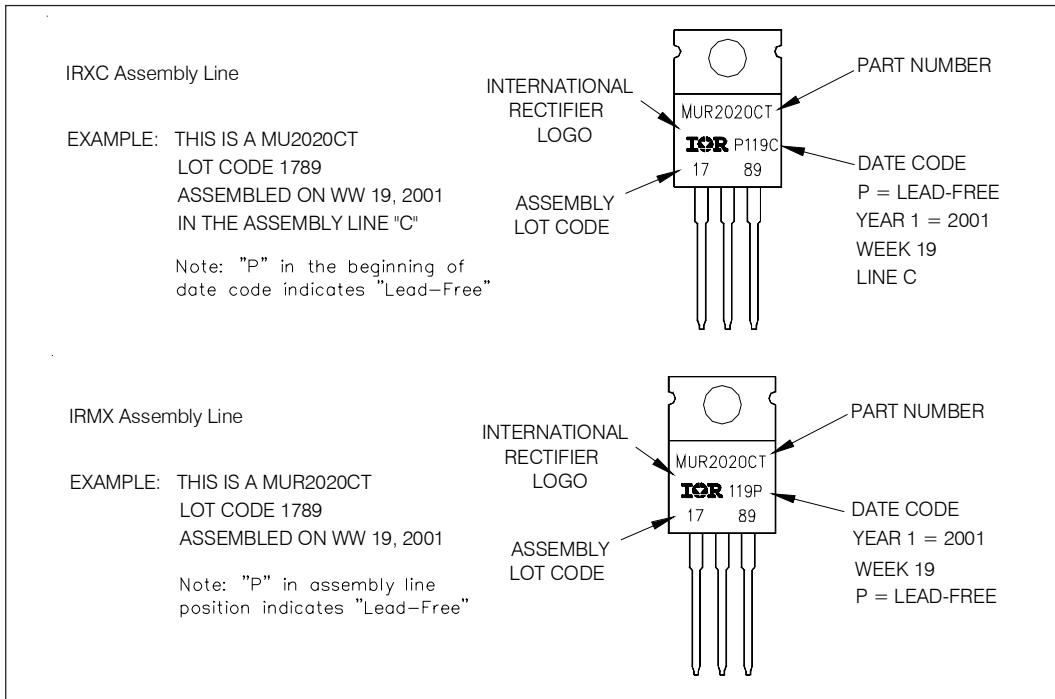

Fig. 10 - Reverse Recovery Waveform and Definitions

Outline Table



Part Marking Information



Ordering Information Table

**Device Code**

<b>MUR</b>	<b>20</b>	<b>20</b>	<b>CT</b>	<b>PbF</b>
①	②	③	④	⑤

<b>1</b>	- Ultrafast MUR Series
<b>2</b>	- Current Rating (20 = 20A)
<b>3</b>	- Voltage Rating (20 = 200V)
<b>4</b>	- CT = Center Tap (Dual)
<b>5</b>	- • none = Standard Production • PbF = Lead-Free

Tube Standard Pack Quantity : 50 pieces

```

MUR2020
*****
* SPICE Model Diode *
*****
.SUBCKT MUR2020 ANO CAT
D1 ANO 1 CAT
*Define diode model
.MODEL DMOD D (IS=1.04703N N=1.44364 BV=280 IBV=100P RS=7.57994M
+ CJO=218.618P VJ=700M M=399.212M EG=1.11 RL=17.4782G)

*****

.ENDS MUR2020

Thermal Model Subcircuit
.SUBCKT MUR2020 5 1

CTHERM1 5 4 3.93E+01
CTHERM2 4 3 2.67E+02
CTHERM3 3 2 5.20E+02
CTHERM4 2 1 1.66E+03

RTHERM1 5 4 1.12E+00
RTHERM2 4 3 1.04E+00
RTHERM1 3 2 1.57E-01
RTHERM1 2 1 1.89E-01

.ENDS MUR2020
    
```

MUR2020CTPbF

Bulletin PD-20895 rev. A 12/05

International  
**IOR** Rectifier

---

Data and specifications subject to change without notice.  
This product has been designed and qualified for Industrial Level and Lead-Free.  
Qualification Standards can be found on IR's Web site.

International  
**IOR** Rectifier

**IR WORLD HEADQUARTERS:** 233 Kansas St., El Segundo, California 90245, USA Tel: (310) 252-7105  
TAC Fax: (310) 252-7309  
Visit us at [www.irf.com](http://www.irf.com) for sales contact information. 12/04