

**GaAs SPDT Terminated Switch
DC - 3.0 GHz**

MASW-007935
V1

Features

- Low Insertion Loss: < 0.6 dB @ 900 MHz
- High Isolation: > 38 dB @ 900 MHz
- Low Power Consumption: < 10 μ A @ -3 V
- Positive or Negative 2.5 to 8 V Control
- Lead-Free SOT-26 Package
- 100% Matte Tin Plating over Copper
- Halogen-Free "Green" Mold Compound
- 260°C Reflow Compatible
- RoHS* Compliant Version of SW-442

Description

M/A-COM's MASW-007935 is a GaAs monolithic switch in a low cost lead-free SOT-26 surface mount plastic package. The MASW-007935 is ideally suited for applications where very low power consumption, low insertion loss and very small size are required.

Typical application is in dual band systems which require switching between small signal components such as filter banks, single band LNA's, converters etc. The MASW-007935 can be used in applications up to 0.25 Watts in systems such as CDMA, W-CDMA, PCS, DCS1800, GSM and other analog/digital wireless communications systems.

The MASW-007935 is fabricated using a mature 0.5 micron GaAs PHEMT process. The process features full passivation for increased performance and reliability.

Ordering Information ¹

| Part Number | Package |
|--------------------|-----------------|
| MASW-007935-000000 | Bulk Packaging |
| MASW-007935-TR1000 | 1000 piece reel |

1. Reference Application Note M513 for reel size information.

**Functional Schematic
Positive Control Voltage**

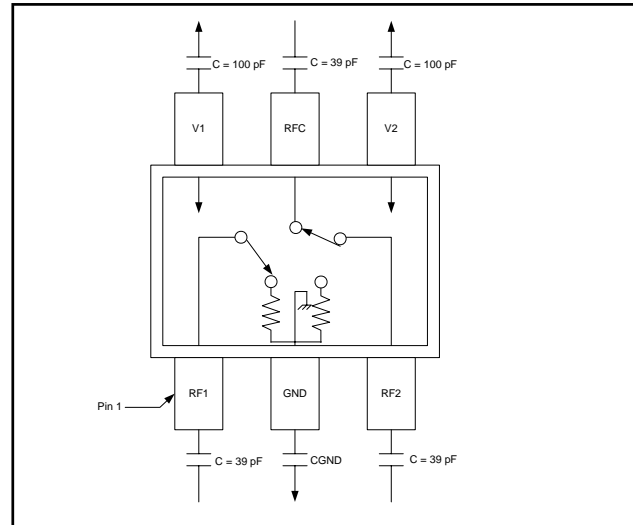

**Functional Schematic
Negative Control Voltage**

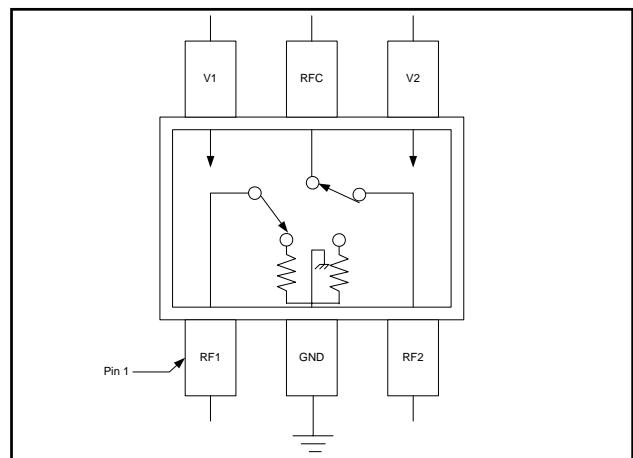

Pin Configuration

| PIN No. | Function | Description |
|---------|----------|-----------------|
| 1 | RF1 | RF Input/Output |
| 2 | GND | RF Ground |
| 3 | RF2 | RF Input/Output |
| 4 | V2 | V Control 2 |
| 5 | RFC | RF Common |
| 6 | V1 | V Control 1 |

* Restrictions on Hazardous Substances, European Union Directive 2002/95/EC.

**GaAs SPDT Terminated Switch
DC - 3.0 GHz**

**MASW-007935
V1**

Electrical Specifications: $T_A = 25^\circ\text{C}$, $Z_0 = 50\ \Omega$, $V_{CTL} = -3\text{V}$ (unless otherwise specified)

| Parameter | Test Conditions | Units | Min | Typ | Max |
|---|---|---------------|-----|-------|-------|
| Insertion Loss ³ | DC-1 GHz | dB | — | 0.5 | 0.7 |
| | 1-2 GHz | dB | — | 0.8 | 1.0 |
| | 2-3 GHz | dB | — | 1.1 | 1.25 |
| Isolation | DC-1 GHz | dB | 36 | 38 | — |
| | 1-2 GHz | dB | 25 | 28 | — |
| | 2-3 GHz | dB | 21 | 22 | — |
| VSWR | DC-2 GHz | Ratio | — | 1.4:1 | 1.5:1 |
| | 2-3 GHz | Ratio | — | 1.6:1 | 1.7:1 |
| P_{1dB} (2.7 V supply) | 500 MHz - 3 GHz | dBm | — | 24 | — |
| P_{1dB} (5 V supply) | 500 MHz - 3 GHz | dBm | — | 28 | — |
| IP_2 (2.7 V supply) | 2-Tone 900 MHz, 5 MHz spacing, 10 dBm each tone | dBm | — | 80 | — |
| IP_3 (2.7 V supply) | 2-Tone 900 MHz, 5 MHz spacing, 10 dBm each tone | dBm | — | 50 | — |
| T_{rise} , T_{fall} T_{on} , T_{off} Transients | 10% to 90% RF, 90% to 10% RF | nS | — | 40 | — |
| | 50% Control to 90% RF, 50% Control to 10% RF | nS | — | 60 | — |
| | In-Band | mV | — | 10 | — |
| Control Current | $V_{CTL} = -3\text{V}$ | μA | — | 6 | 15 |

2. External DC blocking capacitors are required on all RF ports when using positive voltage control.

3. Insertion loss can be optimized by varying the DC blocking capacitor value, e.g. 1000 pF for 100 MHz - 1 GHz, 39 pF for 0.5 GHz - 3 GHz.

Absolute Maximum Ratings^{4,5}

| Parameter | Absolute Maximum |
|---|--------------------|
| Input Power (0.5 - 3.0 GHz) 3 V Control 5 V Control | +30 dBm +33 dBm |
| Operating Voltage | +8.5 Volts |
| Operating Temperature | -40°C to +85°C |
| Storage Temperature | -65°C to +150°C |

4. Exceeding any one or combination of these limits may cause permanent damage to this device.

5. M/A-COM does not recommend sustained operation near these survivability limits.

Handling Procedures

Please observe the following precautions to avoid damage:

Static Sensitivity

Gallium Arsenide Integrated Circuits are sensitive to electrostatic discharge (ESD) and can be damaged by static electricity. Proper ESD control techniques should be used when handling these devices.

Truth Table

| Mode (Control) | V1 | V2 | RFC - RF1 | RFC - RF2 |
|-----------------------|-----------------------|-----------------------|-----------|-----------|
| Positive ⁶ | $0 \pm 0.2\ \text{V}$ | +2.5 to +8 V | On | Off |
| | +2.5 to +8 V | $0 \pm 0.2\ \text{V}$ | Off | On |
| Negative ⁷ | $0 \pm 0.2\ \text{V}$ | -2.5 to -8 V | Off | On |
| | -2.5 to -8 V | $0 \pm 0.2\ \text{V}$ | On | Off |

6. External DC blocking capacitors are required on all RF ports and GND. GND capacitors can be used with positive control voltage to resonate lead inductance for improved isolation.

7. If negative control is used, DC blocking capacitors and GND capacitors are not required.

**GaAs SPDT Terminated Switch
DC - 3.0 GHz**

MASW-007935
V1

Typical Performance Curves

Output VSWR vs. Frequency over Temperature

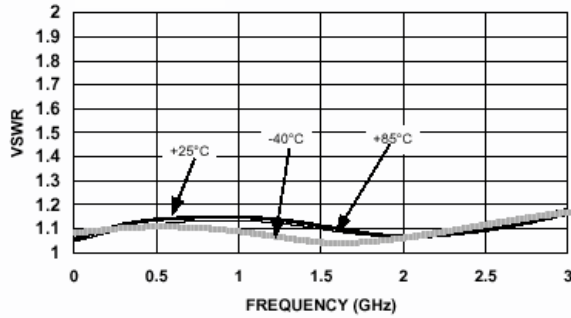

Input VSWR vs. Frequency over Temperature

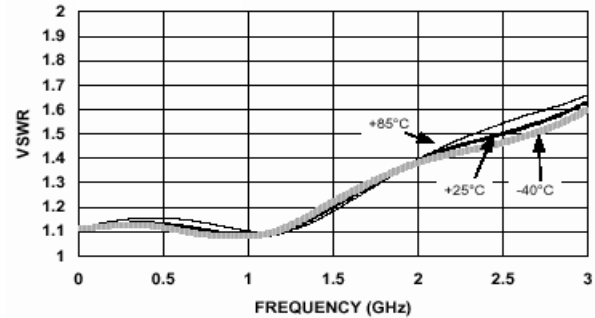

Isolation vs. Frequency over Temperature (Positive Control)

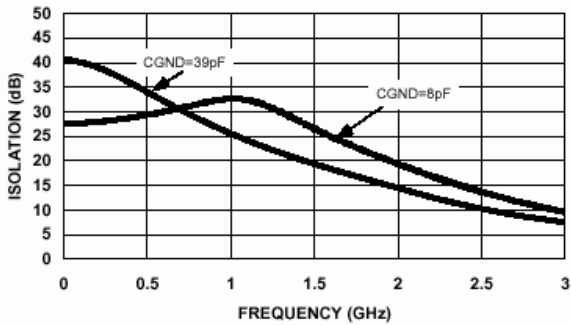

Isolation vs. Frequency over Temperature (Negative Control)

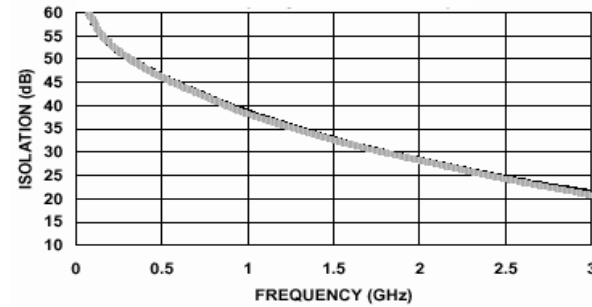

Insertion Loss vs. Frequency over Temperature (Positive Control)

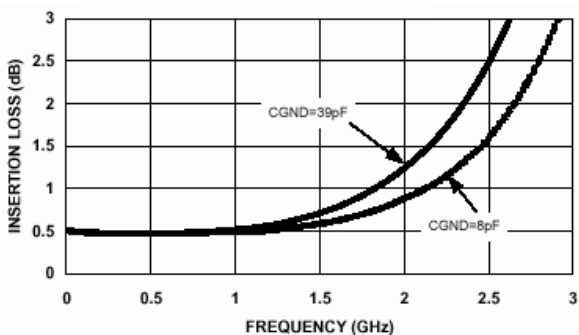

Insertion Loss vs. Frequency over Temperature (Negative Control)

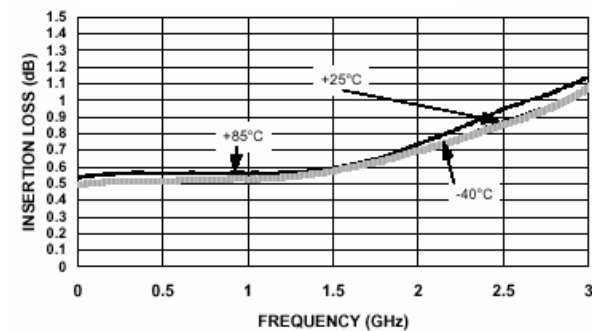

**GaAs SPDT Terminated Switch
DC - 3.0 GHz**

**MASW-007935
V1**

Lead-Free SOT-26 Plastic Package†

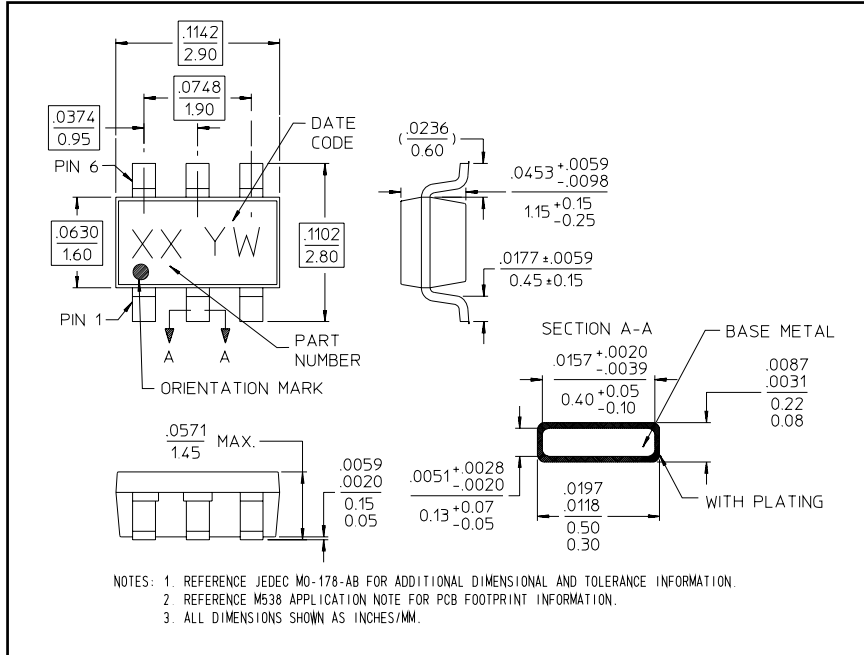

† Reference Application Note M538 for lead-free solder reflow recommendations.