

SPECIFICATIONS

Electrical Ratings	50mA @ 48VDC
Electrical Life	100,000 cycles typical
Contact Resistance	< 50 mΩ initial
Actuation Force	160 +/- 50gF
Actuator Travel	.25 +/- .1mm
Dielectric Strength	1000Vrms min
Insulation Resistance	> 100MΩ min
Operating Temperature	-40°C to 85°C
Storage Temperature	-40°C to 85°C



MATERIALS ←RoHS COMPLIANT

Actuator	4/6 Nylon
Housing	4/6 Nylon
Cover	Steel
Contacts	Phosphor Bronze, Silver Plated
Terminals	Brass, Silver Plated

ORDERING INFORMATION

1. Series:	CS1110A	3.1
CS1110		
CS1110A w/ grounding tab		
CS1110J w/ J lead terminals		
CS1110M w/ mounting stems		
2. Actuator Length "L" (mm):		
2.0		
2.3		
2.5		
3.1		

DIMENSIONS

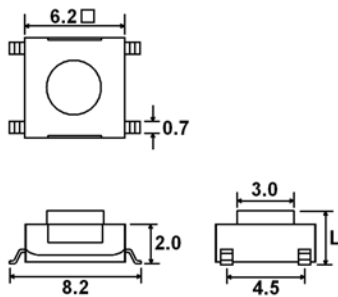

CS1110

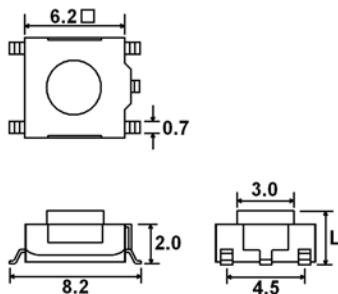

CS1110A

SCHEMATIC & PC LAYOUT

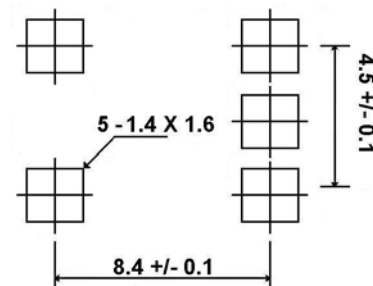
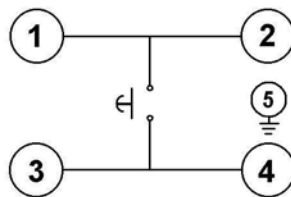
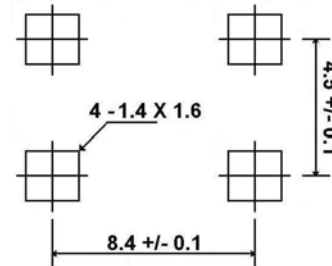
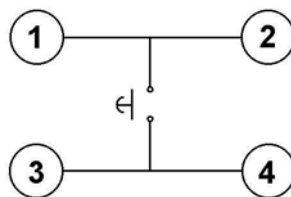

DIMENSIONS

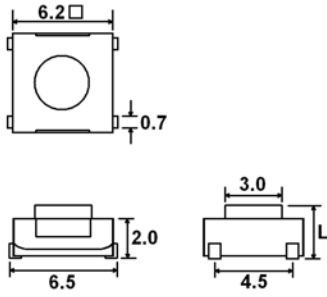

CS1110J

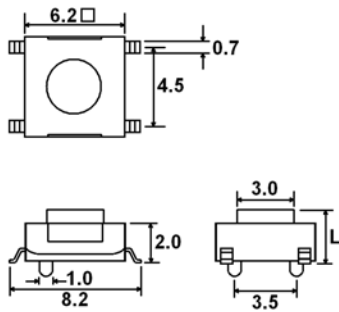

CS1110M

SCHEMATIC & PC LAYOUT

