

Smart Lowside Power Switch

Features

- Logic Level Input
- Input protection (ESD)
- Thermal shutdown (with restart)
- Overload protection
- Short circuit protection
- Overvoltage protection
- Current limitation

Product Summary

Continuous drain source voltage	V_{DS}	55	V
On-state resistance	$R_{DS(ON)}$	550	m Ω
Current limitation	$I_{D(lim)}$	1	A
Nominal load current	$I_{D(Nom)}$	0.7	A
Clamping energy	E_{AS}	550	mJ

Application

- All kinds of resistive, inductive and capacitive loads in switching applications
- μ C compatible power switch for 12 V and 24 V DC applications
- Replaces electromechanical relays and discrete circuits

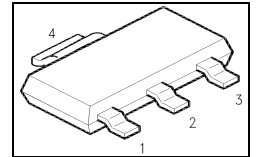

General Description

N channel vertical power FET in **Smart Power Technology**. Fully protected by embedded protection functions.

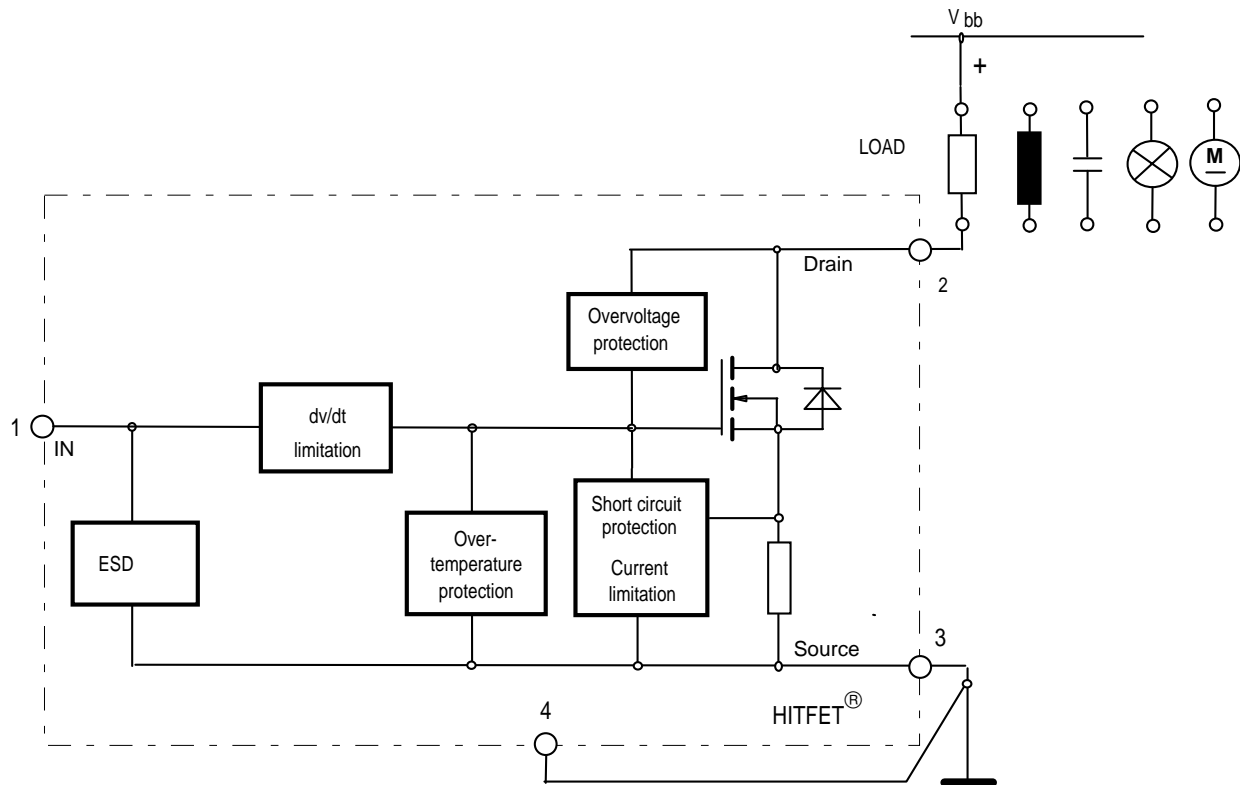

Pin	Symbol	Function
1	IN	Input
2	DRAIN	Output to the load
3	SOURCE	Ground
TAB	SUBSTRATE	Must be connected to Pin 3

Maximum Ratings at $T_j=25^\circ\text{C}$ unless otherwise specified

Parameter	Symbol	Values	Unit	
Continuous drain source voltage (overvoltage protection see page 4)	V_{DS}	55	V	
Drain source voltage for short circuit protection	V_{DS}	32	V	
Load dump protection $V_{LoadDump}=U_P+U_S$; $U_P=13.5\text{ V}$ $R_l^1=2\ \Omega$; $t_d=400\text{ms}$; IN=low or high (8V) $R_L=50\ \Omega$ $R_l=2\ \Omega$; $t_d=400\text{ms}$; IN=high (8V) $R_L=22\ \Omega$	$V_{LoadDump}^{2)}$	80 47	V	
Continuous input voltage	V_{IN}	-0.2 ... +10	V	
Peak input voltage	V_{IN}	-0.2 ... +20	V	
Operating temperature range	T_j	-40 ... +150	$^\circ\text{C}$	
Storage temperature range	T_{stg}	-55 ... +150		
Power dissipation (DC)	P_{tot}	1.8	W	
Unclamped single pulse inductive energy $I_{D(ISO)} = 0.7\text{ A}$	E_{AS}	550	mJ	
Electrostatic discharge voltage (Human Body Model) according to MIL STD 883D, method 3015.7 and EOS/ESD assn. standard S5.1 - 1993	V_{ESD}	4000	V	
DIN humidity category, DIN 40 040		E		
IEC climatic category, DIN IEC 68-1		40/150/56		
Thermal resistance	junction soldering point: junction - ambient ³⁾ :	R_{thJS} R_{thJA}	≤ 10 ≤ 70	K/W

¹⁾ R_l =internal resistance of the load dump test pulse generator LD200

²⁾ $V_{LoadDump}$ is setup without DUT connected to the generator per ISO 7637-1 and DIN 40 839.

³⁾ Device on epoxy pcb 40mm x 40 mm x 1.5mm with 6cm² copper area for pin 4 connection

Electrical Characteristics

Parameter and Conditions at $T_j = 25^\circ\text{C}$, unless otherwise specified	Symbol	Values			Unit
		min	typ	max	

Static Characteristics

Drain source clamp voltage $I_D = 10\text{ mA}$ $T_j = -40\dots+150^\circ\text{C}$:	$V_{DS(AZ)}$	55	--	70	V	
Off state drain current $V_{IN} = 0\text{ V}$, $V_{DS} = 32\text{ V}$ $T_j = -40\dots+150^\circ\text{C}$:	I_{DSS}	--	--	5	μA	
Input threshold voltage $I_D = 10\text{ mA}$	$V_{IN(th)}$	2	2.5	3	V	
Input current $V_{IN} = 5\text{ V}$ normal operation, $I_D < I_{D(lim)}$: current limitation mode, $I_D = I_{D(lim)}$: after thermal shutdown, $I_D = 0\text{ A}$:	$I_{IN(1)}$	--	100	200	μA	
	$I_{IN(2)}$	--	200	300		
	$I_{IN(3)}$	1000	1500	2000		
On-state resistance $I_D = 0.7\text{ A}$, $V_{IN} = 5\text{ V}$	$R_{DS(on)}$	$T_j = 25^\circ\text{C}$:	--	550	675	$\text{m}\Omega$
		$T_j = 150^\circ\text{C}$:	--	850	1350	
On-state resistance $I_D = 0.7\text{ A}$, $V_{IN} = 10\text{ V}$	$R_{DS(on)}$	$T_j = 25^\circ\text{C}$:	--	475	550	$\text{m}\Omega$
		$T_j = 150^\circ\text{C}$:	--	750	1000	
Nominal load current $V_{BB} = 12\text{ V}$, $V_{DS} = 0.5\text{ V}$, $T_S = 85^\circ\text{C}$ $T_j < 150^\circ\text{C}$	$I_{D(Nom)}$	0.7	--	--	A	
Current limit $V_{IN} = 10\text{ V}$, $V_{DS} = 12\text{ V}$	$I_{D(lim)}$	1	1.5	1.9	A	

Dynamic characteristics

Turn-on time $R_L = 22\ \Omega$, $V_{IN} = 0\text{ to }10\text{ V}$, $V_{bb} = 12\text{ V}$ V_{IN} to 90% I_D :	t_{on}	--	10	20	μs
Turn-off time $R_L = 22\ \Omega$, $V_{IN} = 10\text{ to }0\text{ V}$, $V_{bb} = 12\text{ V}$ V_{IN} to 10% I_D :	t_{off}	--	10	20	μs
Slew rate on $R_L = 22\ \Omega$, $V_{IN} = 0\text{ to }10\text{ V}$, $V_{bb} = 12\text{ V}$ 70 to 50% V_{bb} :	$-dV_{DS}/dt_{on}$	--	4	10	$\text{V}/\mu\text{s}$
Slew rate off $R_L = 22\ \Omega$, $V_{IN} = 10\text{ to }0\text{ V}$, $V_{bb} = 12\text{ V}$ 50 to 70% V_{bb} :	dV_{DS}/dt_{off}	--	4	10	$\text{V}/\mu\text{s}$

Parameter and Conditions at $T_j = 25\text{ °C}$, unless otherwise specified	Symbol	Values			Unit
		min	typ	max	

Protection Functions

Thermal overload trip temperature	T_{jt}	150	165	--	°C	
Thermal hysteresis	ΔT_{jt}	--	10	--	K	
Unclamped single pulse inductive energy $I_{D(ISO)}=0.7\text{ A}$, $V_{bb}=32\text{ V}$	E_{AS}	$T_j=25\text{ °C}$	550	--	--	mJ
		$T_j=150\text{ °C}$	200	--	--	

Inverse Diode

Continuous source drain voltage $V_{IN} = 0\text{ V}$, $-I_D = 2 \cdot 0.7\text{ A}$	V_{SD}	--	1	--	V
--	----------	----	---	----	---

Circuit Description

The BSP 75 is a monolithic power switch in Smart Power Technology (SPT) with a logic level input, an open drain DMOS output stage and integrated protection functions. It is designed for all kind of resistive and inductive loads (relays, solenoid) in automotive and industrial applications.

Protection functions

- **Overvoltage protection:** An internal clamp limits the output voltage at $V_{DS(AZ)}$ (about 63 V) when inductive loads are switched off.
- **Current limitation:** By means of an internal current measurement the drain current is limited at $I_{D(lim)}$ (1.4 - 1.5 A typ.). If the current limitation is active the device operates in the linear region, so power dissipation may exceed the capability of the heatsink. This operation leads to an increasing junction temperature until the overtemperature threshold is reached.
- **Overtemperature and short circuit protection:** This protection is based on sensing the chip temperature. The location of the sensor ensures a fast and accurate junction temperature detection. Overtemperature shutdown occurs at minimum 150 °C. A hysteresis of typ. 10 K enables an automatical restart by cooling.

The device is ESD protected according Human Body Model (4 kV) and load dump protected (see Maximum Ratings).

Block diagram

Terms

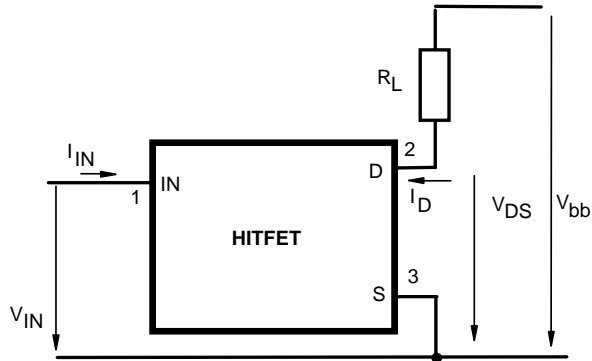

Input circuit (ESD protection)

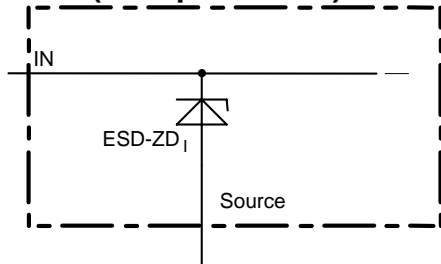

ESD zener diodes are not designed for DC current.

Inductive and overvoltage output clamp

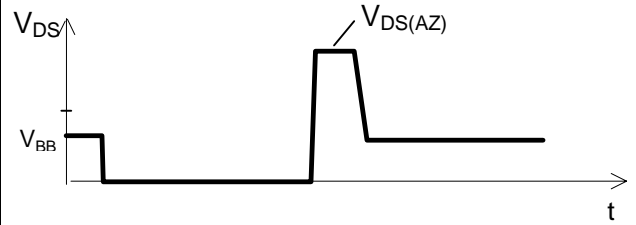
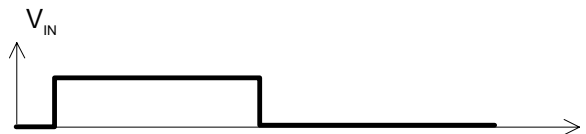
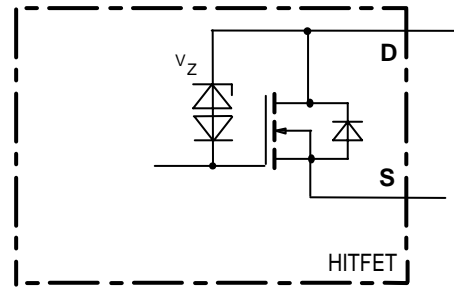

Turn on into overload or short circuit

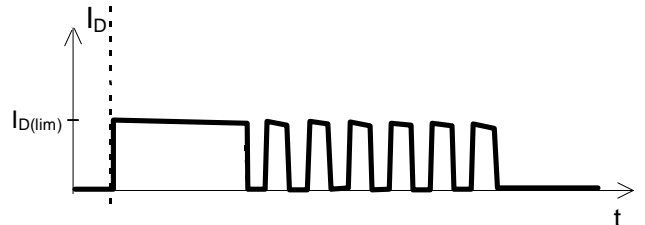
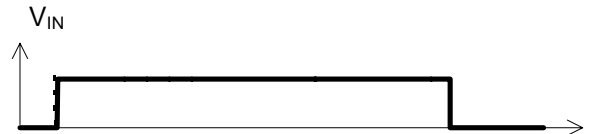

Shut down by overtemperature and restart by cooling. Current internally limited at $I_{D(lim)}$.

Maximum allowable power dissipation

$$P_{tot} = f(T_C)$$

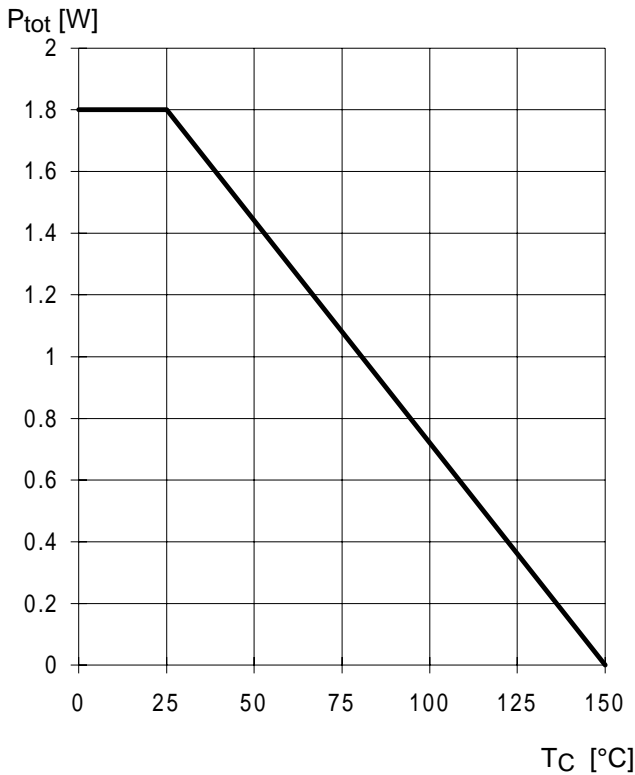

On-state resistance

$$R_{ON} = f(T_j); I_D = 0.7 \text{ A}; V_{IN} = 10 \text{ V}$$

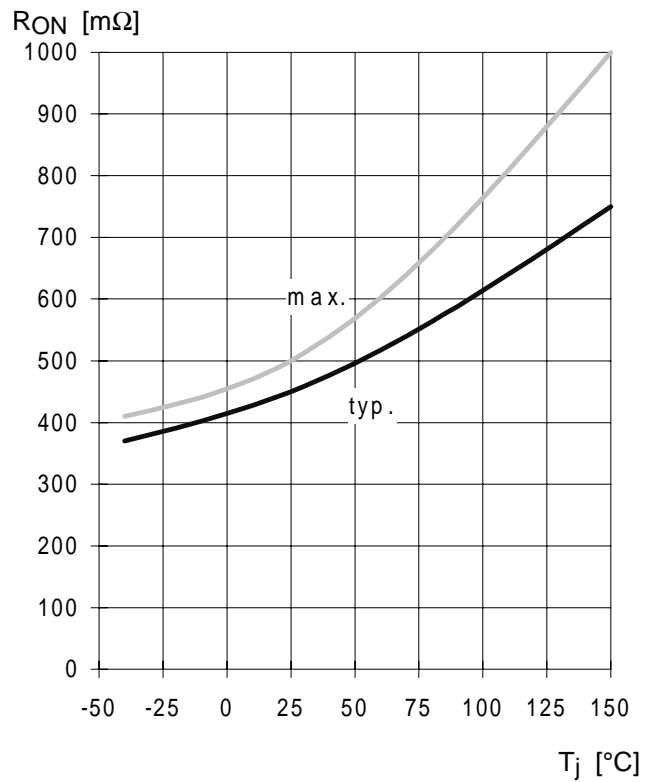

On-state resistance

$$R_{ON} = f(T_j); I_D = 0.7 \text{ A}; V_{IN} = 5 \text{ V}$$

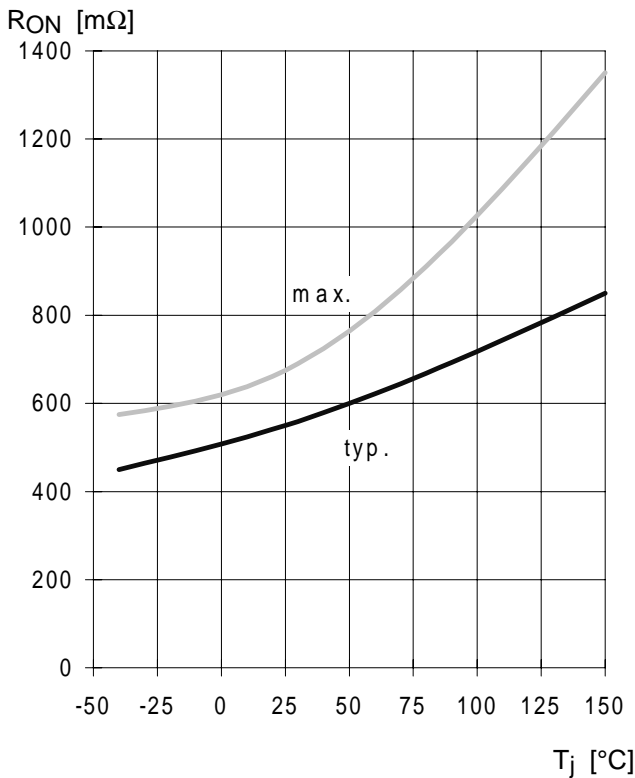

Typ. input threshold voltage

$$V_{IN(th)} = f(T_j); I_D = 10 \text{ mA}; V_{DS} = 12 \text{ V}$$

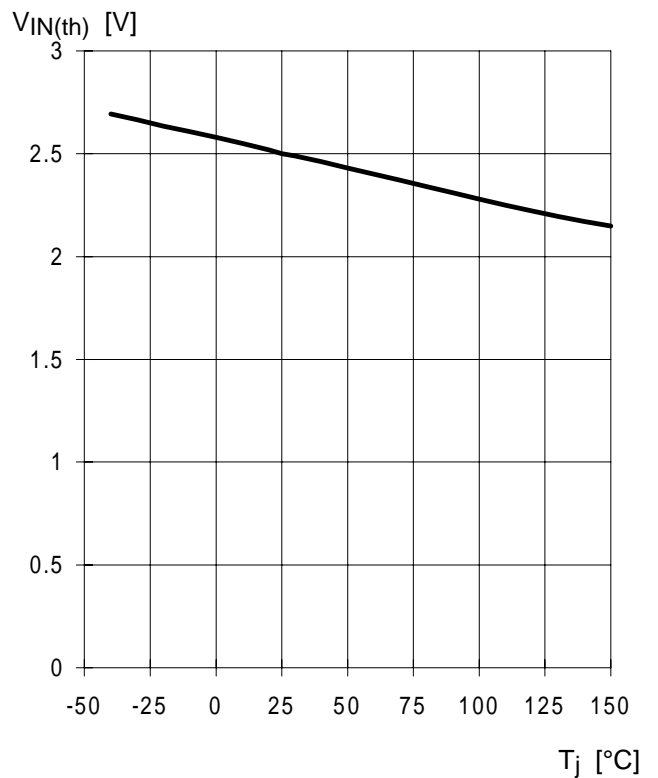

Typ. on-state resistance
 $R_{ON} = f(V_{IN})$ $I_D = 0.7 \text{ A}$; $T_j = 25^\circ\text{C}$

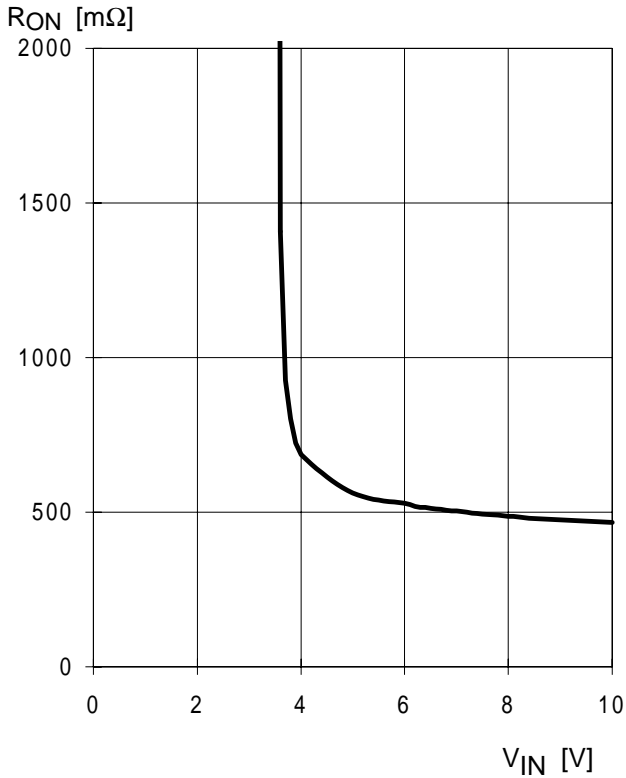

Typ. short circuit current
 $I_{D(SC)} = f(V_{IN})$; $V_{DS} = 12\text{V}$, $T_j = 25^\circ\text{C}$

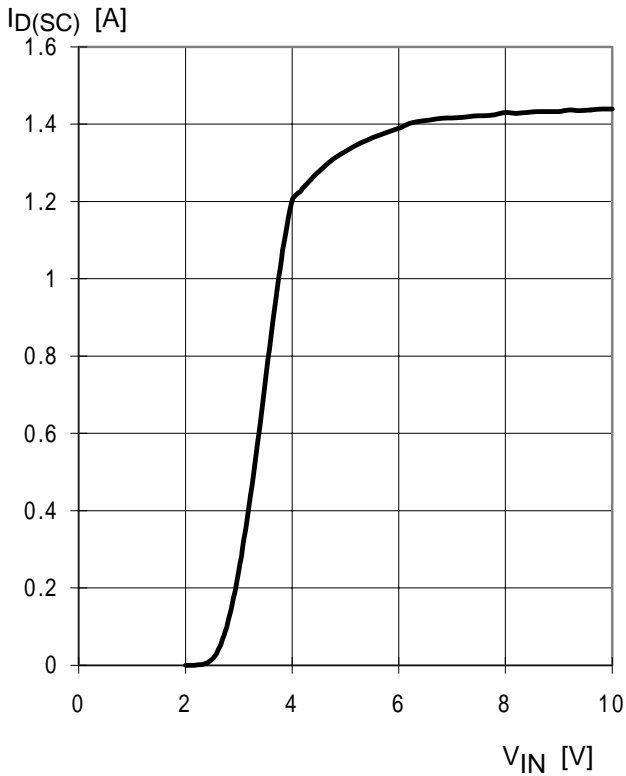

Typ. current limitation
 $I_{D(lim)} = f(T_j)$; $V_{DS} = 12\text{V}$, $V_{IN} = 10\text{V}$

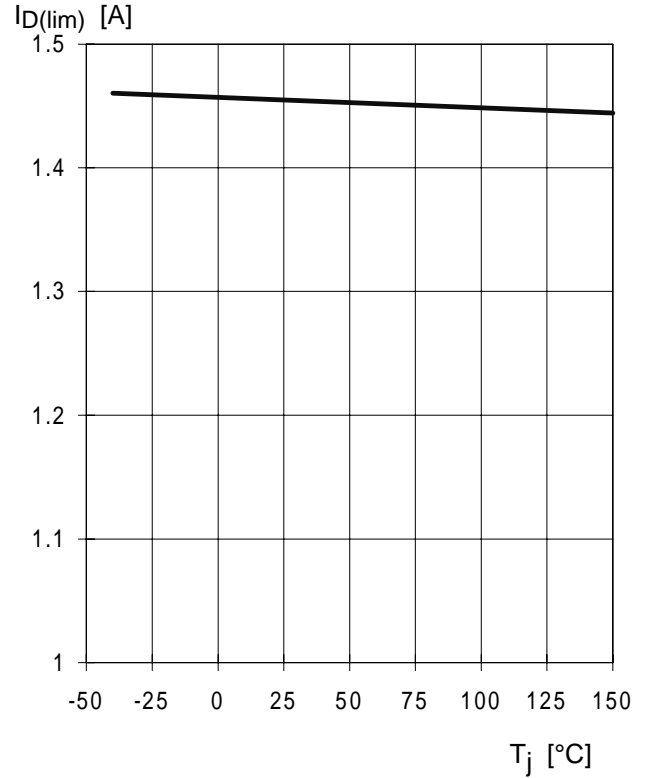

Transient thermal impedance
 $Z_{thJC} = f(t_p)$
 Parameter: $D = t_p / T$

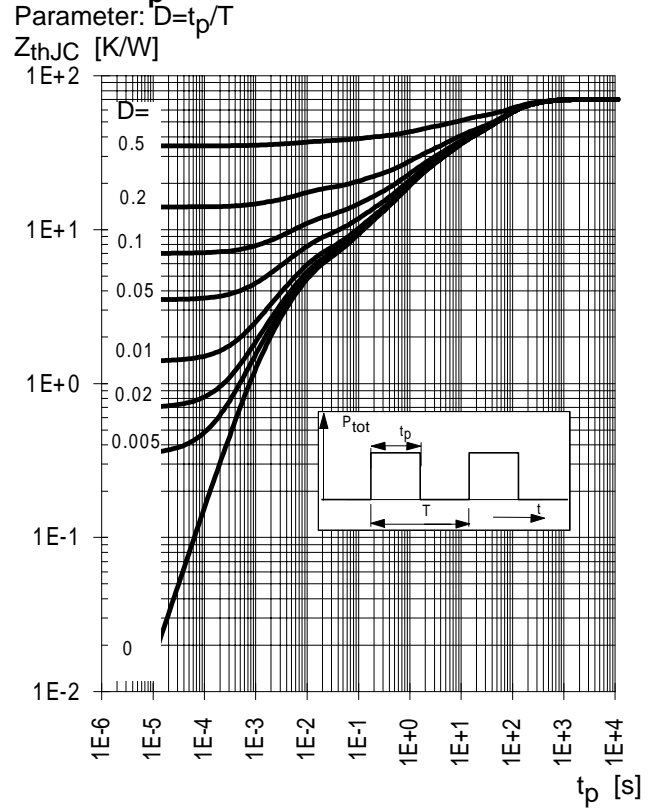

Application examples:

Status signal of thermal shutdown by monitoring input current

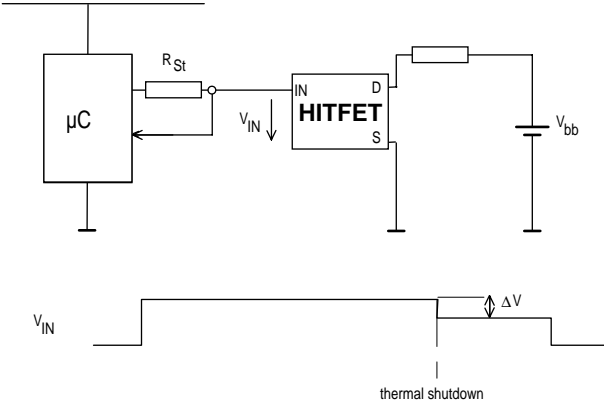

Package and ordering code

all dimensions in mm

SOT223/4

Ordering code

BSP75	Q67060-S7200-A2
-------	-----------------

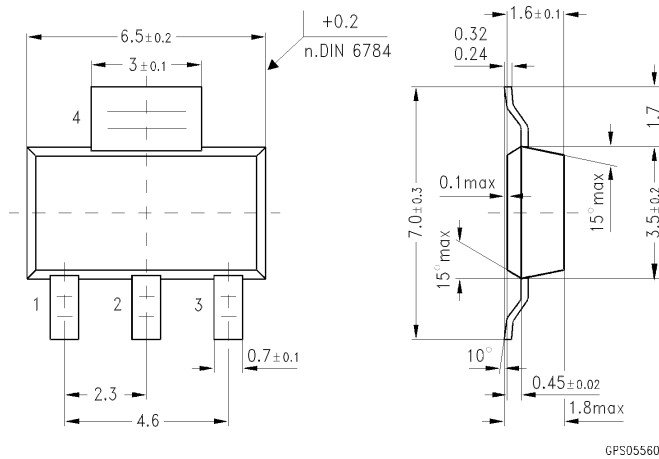

Definition of soldering point with temperature T_s :
upper side of solder edge of device pin 4.

