

NL27WZU04

Dual Unbuffered Inverter

The NL27WZU04 is a high performance dual unbuffered inverter operating from a 1.65 to 5.5 V supply. These devices are well suited for use as oscillators, pulse shapers, and in many other applications requiring a high-input impedance amplifier. For digital applications, the NL27WZ04 is recommended.

Features

- Pb-Free Package is Available
- Designed for 1.65 V to 5.5 V V_{CC} Operation
- Unbuffered for Crystal Oscillator and Analog Applications
- LVC MOS Compatible
- Source/Sink ± 16 mA @ 4.5 V V_{CC}
- Near Zero Static Supply Current Substantially Reduces System Power Requirements
- Chip Complexity: FET = 72; Equivalent Gate = 18

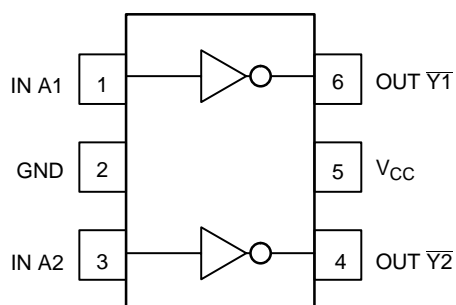

Figure 1. Pinout (Top View)

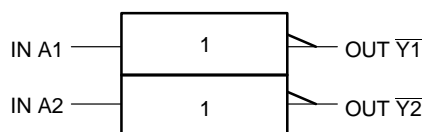

Figure 2. Logic Symbol

FUNCTION TABLE

A Input	\bar{Y} Output
L	H
H	L



ON Semiconductor®

<http://onsemi.com>

MARKING DIAGRAMS



SC-88 / SOT-363/SC-70
DF SUFFIX
CASE 419B

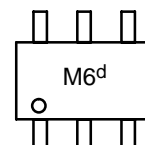

Pin 1
d = Date Code

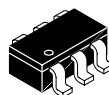

TSOP-6/SOT-23/SC-59
DT SUFFIX
CASE 318G

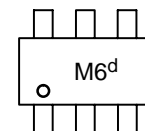

Pin 1
d = Date Code

PIN ASSIGNMENT

1	IN A1
2	GND
3	IN A2
4	OUT $\bar{Y}2$
5	V_{CC}
6	OUT $\bar{Y}1$

ORDERING INFORMATION

See detailed ordering and shipping information in the package dimensions section on page 4 of this data sheet.

NL27WZU04

MAXIMUM RATINGS

Symbol	Characteristics	Value	Unit
V _{CC}	DC Supply Voltage	-0.5 to +7.0	V
V _I	DC Input Voltage	-0.5 ≤ V _I ≤ V _{CC}	V
V _O	DC Output Voltage	-0.5 to 7.0	V
I _{IK}	DC Input Diode Current V _I < GND	-50	mA
I _{OK}	DC Output Diode Current V _O < GND V _O > V _{CC}	-50 +50	mA
I _O	DC Output Sink Current	±50	mA
I _{CC}	DC Supply Current per Supply Pin	±100	mA
I _{GND}	DC Ground Current per Ground Pin	±100	mA
T _{STG}	Storage Temperature Range	-65 to +150	°C
P _D	Power Dissipation in Still Air SC-88, TSOP-6	200	mW
θ _{JA}	Thermal Resistance SC-88, TSOP-6	333	°C/W
T _L	Lead Temperature, 1 mm from case for 10 s	260	°C
T _J	Junction Temperature under Bias	+150	°C
V _{ESD}	ESD Withstand Voltage Human Body Model (Note 1) Machine Model (Note 2) Charged Device Model (Note 3)	> 2000 > 200 N/A	V
I _{LatchUp}	LatchUp Performance Above V _{CC} and Below GND at 85°C (Note 4)	±500	mA

Maximum ratings are those values beyond which device damage can occur. Maximum ratings applied to the device are individual stress limit values (not normal operating conditions) and are not valid simultaneously. If these limits are exceeded, device functional operation is not implied, damage may occur and reliability may be affected.

1. Tested to EIA/JESD22-A114-A.
2. Tested to EIA/JESD22-A115-A.
3. Tested to JESD22-C101-A.
4. Tested to EIA/JESD78.

RECOMMENDED OPERATING CONDITIONS

Symbol	Parameter	Min	Max	Unit
V _{CC}	Supply Voltage Operating Data Retention Only	1.65 1.5	5.5 5.5	V
V _I	Input Voltage	0	5.5	V
V _O	Output Voltage (High or LOW State)	0	V _{CC}	V
T _A	Operating Free-Air Temperature	-40	+85	°C
Δt/ΔV	Input Transition Rise or Fall Rate V _{CC} = 2.5 V ± 0.2 V V _{CC} = 3.0 V ± 0.3 V V _{CC} = 5.0 V ± 0.5 V	0 0 0	20 10 5	ns/V

NL27WZU04

DC ELECTRICAL CHARACTERISTICS

Symbol	Parameter	Condition	V _{CC} (V)	T _A = 25°C			-40°C ≤ T _A ≤ 85°C		Unit
				Min	Typ	Max	Min	Max	
V _{IH}	High-Level Input Voltage		1.65 to 1.85	0.85 V _{CC}			0.85 V _{CC}		V
			2.3 to 5.5	0.8 V _{CC}			0.8 V _{CC}		
V _{IL}	Low-Level Input Voltage		1.65 to 1.85			0.15 V _{CC}		0.15 V _{CC}	V
			2.3 to 5.5			0.2 V _{CC}		0.2 V _{CC}	
V _{OH}	High-Level Output Voltage V _{IN} = V _{IL}	I _{OH} = -100 μA	1.65 to 5.5	V _{CC} -0.1			V _{CC} -0.1		V
		V _{IN} = GND							
	I _{OH} = -3 mA	1.65	1.29	1.52		1.29			
	I _{OH} = -4 mA	2.3	1.9	2.1		1.9			
	I _{OH} = -6 mA	2.7	2.2	2.3		2.2			
	I _{OH} = -8 mA	3.0	2.4	2.6		2.4			
	I _{OH} = -12 mA	3.0	2.3	2.5		2.3			
V _{OL}	Low-Level Output Voltage V _{IN} = V _{IH}	I _{OL} = 100 μA	1.65 to 5.5			0.1		0.1	V
		V _{IN} = V _{CC}							
	I _{OL} = 3 mA	1.65		0.08	0.24		0.24		
	I _{OL} = 4 mA	2.3		0.12	0.3		0.3		
	I _{OL} = 6 mA	2.7		0.20	0.4		0.4		
	I _{OL} = 8 mA	3.0		0.24	0.4		0.4		
	I _{OL} = 12 mA	3.0		0.26	0.55		0.55		
I _{IN}	Input Leakage Current	V _{IN} = V _{CC} or GND	5.5			±0.1		±1.0	μA
I _{CC}	Maximum Quiescent Supply Current	V _{IN} = V _{CC} or GND	1.65 to 5.5			1.0		10	μA

AC ELECTRICAL CHARACTERISTICS t_R = t_F = 2.5 ns; C_L = 50 pF; R_L = 500 Ω

Symbol	Parameter	Condition	V _{CC} (V)	T _A = 25°C			-40°C ≤ T _A ≤ 85°C		Unit
				Min	Typ	Max	Min	Max	
t _{PLH} t _{PHL}	Propagation Delay Input A to Y (Figure 3 and 4)	R _L = 1 MΩ, C _L = 50 pF	1.8 ± 0.15	1.5	5.5	1.8	1.5	11.0	ns
		R _L = 1 MΩ, C _L = 15 pF	2.5 ± 0.2	1.2	3.3	5.7	1.2	6.3	
		R _L = 1 MΩ, C _L = 15 pF	3.3 ± 0.3	0.8	2.7	4.1	0.8	4.5	
		R _L = 500 Ω, C _L = 50 pF		1.2	4.0	6.4	1.2	7.0	
		R _L = 1 MΩ, C _L = 15 pF	5.0 ± 0.5	0.5	2.2	3.3	0.5	3.6	
		R _L = 500 Ω, C _L = 50 pF		0.8	3.4	5.6	0.8	6.2	

CAPACITIVE CHARACTERISTICS

Symbol	Parameter	Condition	Typical	Unit
C _{IN}	Input Capacitance	V _{CC} = 5.5 V, V _I = 0 V or V _{CC}	7	pF
C _{OUT}	Output Capacitance	V _{CC} = 5.5 V, V _I = 0 V or V _{CC}	8	pF
C _{PD}	Power Dissipation Capacitance (Note 5)	10 MHz, V _{CC} = 5.5 V, V _I = 0 V or V _{CC}	25	pF

5. C_{PD} is defined as the value of the internal equivalent capacitance which is calculated from the operating current consumption without load. Average operating current can be obtained by the equation: I_{CC(OPR)} = C_{PD} • V_{CC} • f_{in} + I_{CC}. C_{PD} is used to determine the no-load dynamic power consumption; P_D = C_{PD} • V_{CC}² • f_{in} + I_{CC} • V_{CC}.

NL27WZU04

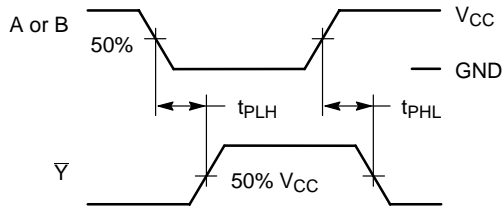

PROPAGATION DELAYS

$t_R = t_F = 2.5 \text{ ns}$, 10% to 90%; $f = 1 \text{ MHz}$; $t_W = 500 \text{ ns}$

Figure 3. Switching Waveforms

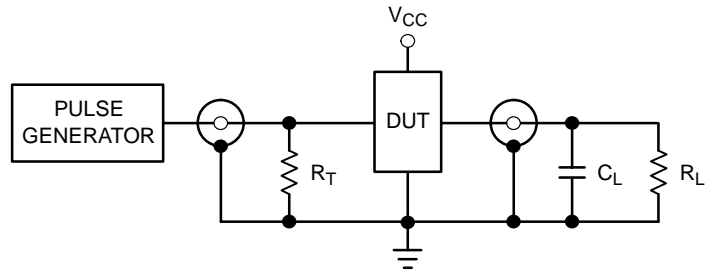

$C_L = 50 \text{ pF}$ or equivalent (includes jig and probe capacitance)
 $R_L = R_1 = 500 \Omega$ or equivalent
 $R_T = Z_{OUT}$ of pulse generator (typically 50Ω)

Figure 4. Test Circuit

DEVICE ORDERING INFORMATION

Device Order Number	Device Nomenclature							Package Type (Name/SOT#/ Common Name)	Tape and Reel Size†
	Logic Circuit Indicator	No. of Gates per Package	Temp Range Identifier	Technology	Device Function	Package Suffix	Tape & Reel Suffix		
NL27WZU04DFT2	NL	2	7	WZ	U04	DF	T2	SC-88 / SOT-363 / SC-70	178 mm (7") 3000 Unit
NL27WZU04DFT2G	NL	2	7	WZ	U04	DF	T2	SC-88 / SOT-363 / SC-70 (Pb-Free)	178 mm (7") 3000 Unit
NL27WZU04DTT1	NL	2	7	WZ	U04	DT	T1	TSOP-6 / SOT-23 / SC-59	178 mm (7") 3000 Unit

†For information on tape and reel specifications, including part orientation and tape sizes, please refer to our Tape and Reel Packaging Specifications Brochure, BRD8011/D.

NL27WZU04

PACKAGE DIMENSIONS

SC70-6/SC-88/SOT-363
 DF SUFFIX
 CASE 419B-02
 ISSUE U

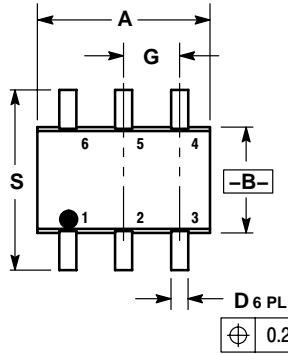

- NOTES:
 1. DIMENSIONING AND TOLERANCING PER ANSI Y14.5M, 1982.
 2. CONTROLLING DIMENSION: INCH.
 3. 419B-01 OBSOLETE, NEW STANDARD 419B-02.

DIM	INCHES		MILLIMETERS	
	MIN	MAX	MIN	MAX
A	0.071	0.087	1.80	2.20
B	0.045	0.053	1.15	1.35
C	0.031	0.043	0.80	1.10
D	0.004	0.012	0.10	0.30
G	0.026 BSC		0.65 BSC	
H	---	0.004	---	0.10
J	0.004	0.010	0.10	0.25
K	0.004	0.012	0.10	0.30
N	0.008 REF		0.20 REF	
S	0.079	0.087	2.00	2.20

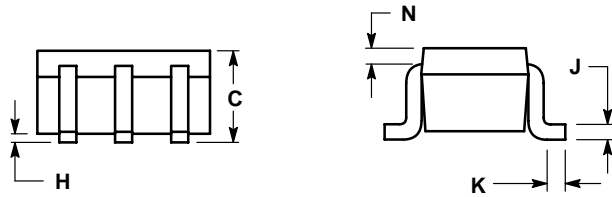

SOLDERING FOOTPRINT*

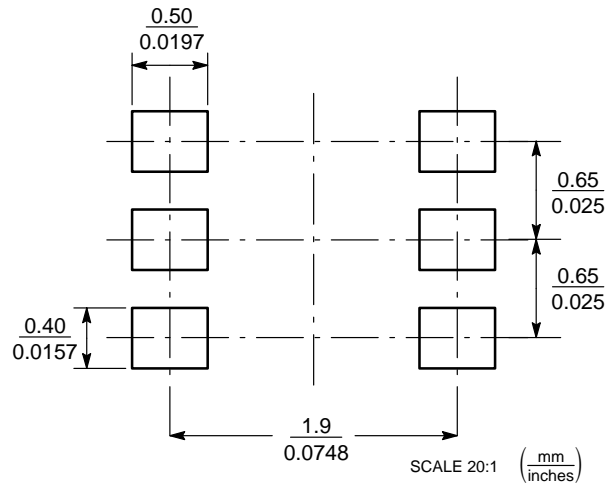

*For additional information on our Pb-Free strategy and soldering details, please download the ON Semiconductor Soldering and Mounting Techniques Reference Manual, SOLDERRM/D.

NL27WZU04

PACKAGE DIMENSIONS

SOT23-6/TSOP-6/SC59-6
DT SUFFIX
CASE 318G-02
ISSUE M

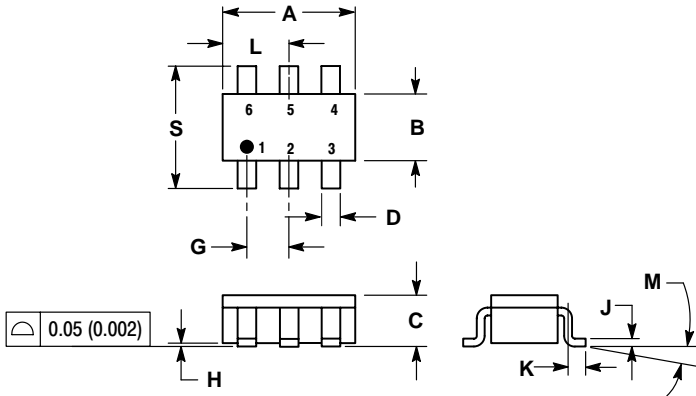

NOTES:

1. DIMENSIONING AND TOLERANCING PER ANSI Y14.5M, 1982.
2. CONTROLLING DIMENSION: MILLIMETER.
3. MAXIMUM LEAD THICKNESS INCLUDES LEAD FINISH THICKNESS. MINIMUM LEAD THICKNESS IS THE MINIMUM THICKNESS OF BASE MATERIAL.
4. DIMENSIONS A AND B DO NOT INCLUDE MOLD FLASH, PROTRUSIONS, OR GATE BURRS.

DIM	MILLIMETERS		INCHES	
	MIN	MAX	MIN	MAX
A	2.90	3.10	0.1142	0.1220
B	1.30	1.70	0.0512	0.0669
C	0.90	1.10	0.0354	0.0433
D	0.25	0.50	0.0098	0.0197
G	0.85	1.05	0.0335	0.0413
H	0.013	0.100	0.0005	0.0040
J	0.10	0.26	0.0040	0.0102
K	0.20	0.60	0.0079	0.0236
L	1.25	1.55	0.0493	0.0610
M	0°	10°	0°	10°
S	2.50	3.00	0.0985	0.1181

SOLDERING FOOTPRINT*

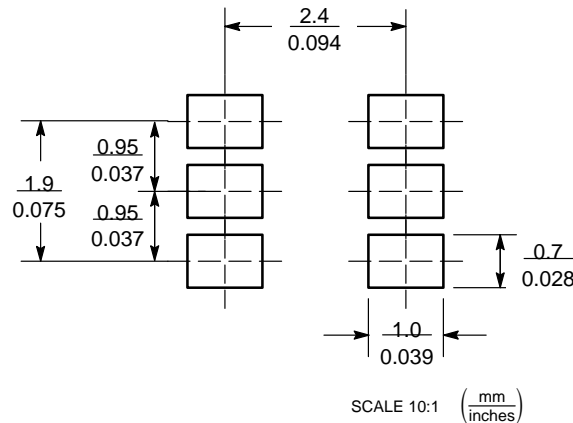

*For additional information on our Pb-Free strategy and soldering details, please download the ON Semiconductor Soldering and Mounting Techniques Reference Manual, SOLDERRM/D.

ON Semiconductor and are registered trademarks of Semiconductor Components Industries, LLC (SCILLC). SCILLC reserves the right to make changes without further notice to any products herein. SCILLC makes no warranty, representation or guarantee regarding the suitability of its products for any particular purpose, nor does SCILLC assume any liability arising out of the application or use of any product or circuit, and specifically disclaims any and all liability, including without limitation special, consequential or incidental damages. "Typical" parameters which may be provided in SCILLC data sheets and/or specifications can and do vary in different applications and actual performance may vary over time. All operating parameters, including "Typicals" must be validated for each customer application by customer's technical experts. SCILLC does not convey any license under its patent rights nor the rights of others. SCILLC products are not designed, intended, or authorized for use as components in systems intended for surgical implant into the body, or other applications intended to support or sustain life, or for any other application in which the failure of the SCILLC product could create a situation where personal injury or death may occur. Should Buyer purchase or use SCILLC products for any such unintended or unauthorized application, Buyer shall indemnify and hold SCILLC and its officers, employees, subsidiaries, affiliates, and distributors harmless against all claims, costs, damages, and expenses, and reasonable attorney fees arising out of, directly or indirectly, any claim of personal injury or death associated with such unintended or unauthorized use, even if such claim alleges that SCILLC was negligent regarding the design or manufacture of the part. SCILLC is an Equal Opportunity/Affirmative Action Employer. This literature is subject to all applicable copyright laws and is not for resale in any manner.

PUBLICATION ORDERING INFORMATION

LITERATURE FULFILLMENT:
Literature Distribution Center for ON Semiconductor
P.O. Box 61312, Phoenix, Arizona 85082-1312 USA
Phone: 480-829-7710 or 800-344-3860 Toll Free USA/Canada
Fax: 480-829-7709 or 800-344-3867 Toll Free USA/Canada
Email: orderlit@onsemi.com

N. American Technical Support: 800-282-9855 Toll Free
USA/Canada

Japan: ON Semiconductor, Japan Customer Focus Center
2-9-1 Kamimeguro, Meguro-ku, Tokyo, Japan 153-0051
Phone: 81-3-5773-3850

ON Semiconductor Website: <http://onsemi.com>

Order Literature: <http://www.onsemi.com/litorder>

For additional information, please contact your local Sales Representative.