



PRELIMINARY SPECIFICATION

MOS FIELD EFFECT POWER TRANSISTOR ARRAY

4PA1572

FAST SWITCHING
N-CHANNEL SILICON POWER MOS FET ARRAY

PACKAGE DIMENSIONS
in millimeters

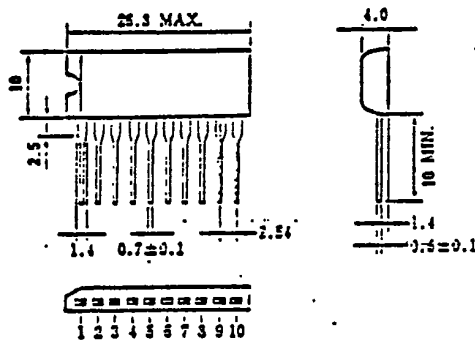

2,4,5,8: Gate
3,5,7,9: Drain
1,10: Source

FEATURES

- Suitable for switching power supplies, actuator controls, and pulse circuits
- Low $R_{DS(on)}$
- No second breakdown

ABSOLUTE MAXIMUM RATINGS ($T_a=25^\circ C$)

- Drain to Source Voltage V_{DS} 60V
- Gate to Source Voltage V_{GS} $\pm 20V$
- Continuous Drain Current $I_D(DC)$ 2A
- Total Power Dissipation P_T 3.5W
- Total Power Dissipation $P_{T\#}$ 22W
- Channel Temperature T_{ch} 150°C
- Storage Temperature T_{stg} -55~150°C
 $+T_c=25^\circ C$

ELECTRICAL CHARACTERISTICS ($T_a=25^\circ C$)

CHARACTERISTIC	SYMBOL	MIN.	TYP.	MAX.	UNIT	TEST CONDITIONS
Drain Leakage Current	I_{DSS}			10	μA	$V_{DS}=60V, V_{GS}=0$
Gate to Source Leakage Current	I_{GSS}			± 100	nA	$V_{GS}=\pm 20V, V_{DS}=0$
Gate to Source Cutoff Voltage	$V_{GS(off)}$	1.0		2.5	V	$V_{DS}=10V, I_D=1mA$
Forward Transfer Admittance	$ y_{fs} $	0.5			S	$V_{DS}=10V, I_D=1A$
Drain to Source On-State Resistance	$R_{DS(on)}$		0.40	0.60	Ω	$V_{GS}=10V, I_D=1A$
			0.60	0.35	Ω	$V_{GS}=4V, I_D=1A$
Input Capacitance	C_{iss}		200		pF	$V_{DS}=10V$
Output Capacitance	C_{oss}		70		pF	$V_{GS}=0$
Reverse Transfer Capacitance	C_{rss}		15		pF	$f=1MHz$
Turn-On Delay Time	$t_d(on)$		45		ns	$I_D=1A, V_{cc}=50V$
Rise Time	t_r		40		ns	$V_{GS(on)}=10V$
Turn-Off Delay Time	$t_d(off)$		450		ns	$R_L=50 \Omega$
Fall Time	t_f		110		ns	

Mar.28.1988 ID-1730

uPA1572H

NEC

TURN-ON AND TURN-OFF TIME TEST CIRCUIT

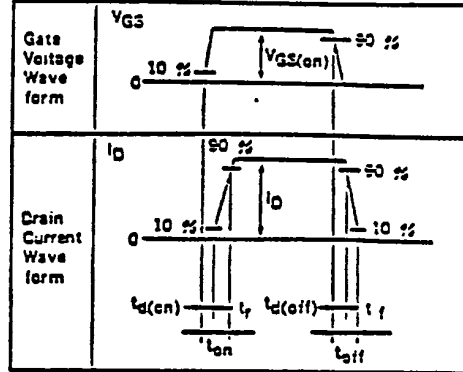
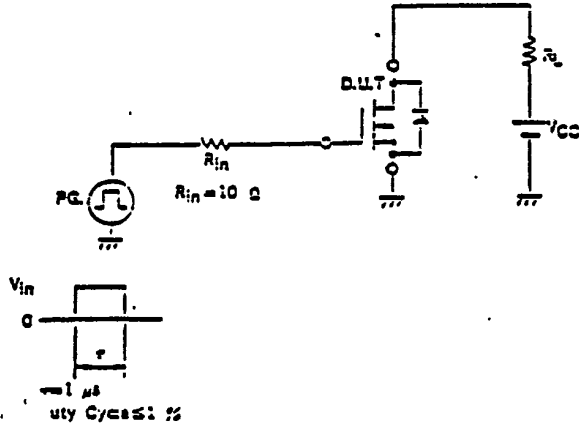

DERATING FACTOR OF FORWARD BIAS SAFE OPERATING AREA

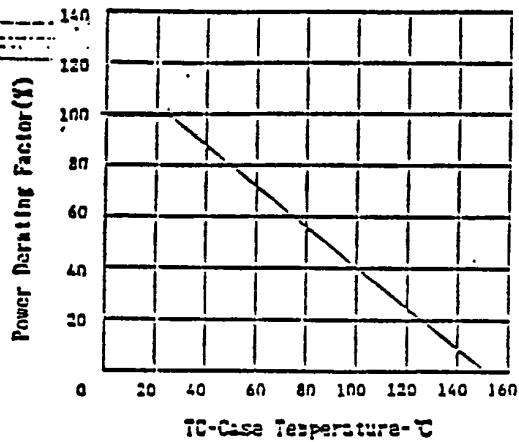

FORWARD BIAS SAFE OPERATING AREA

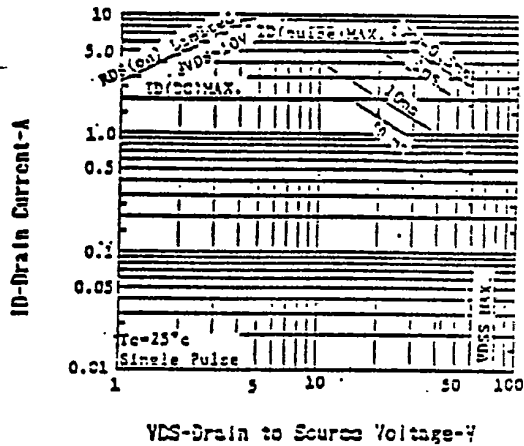

TOTAL POWER DISSIPATION vs. CASE TEMPERATURE

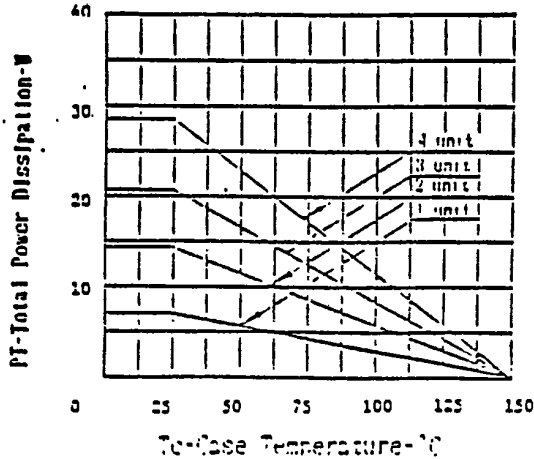

DRAIN CURRENT vs. DRAIN TO SOURCE VOLTAGE

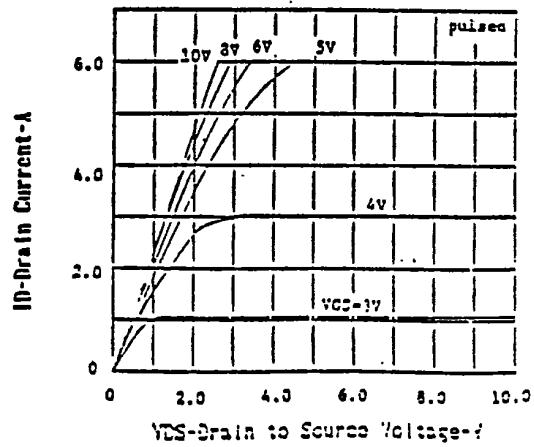



uPA1572H

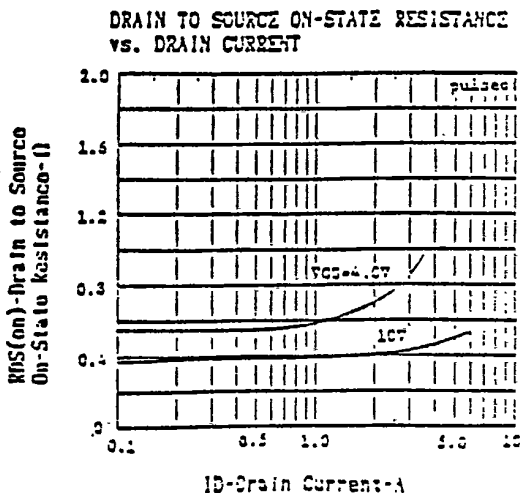
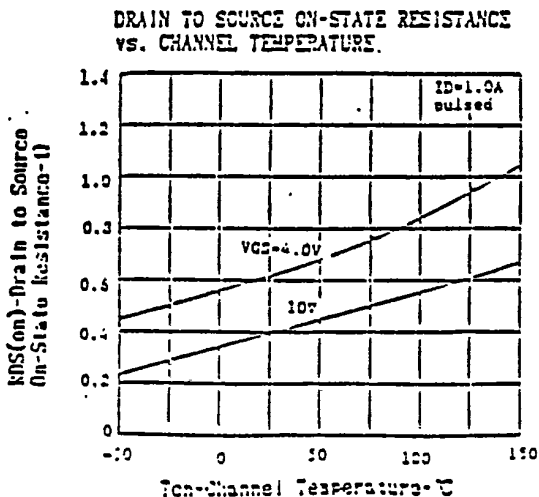
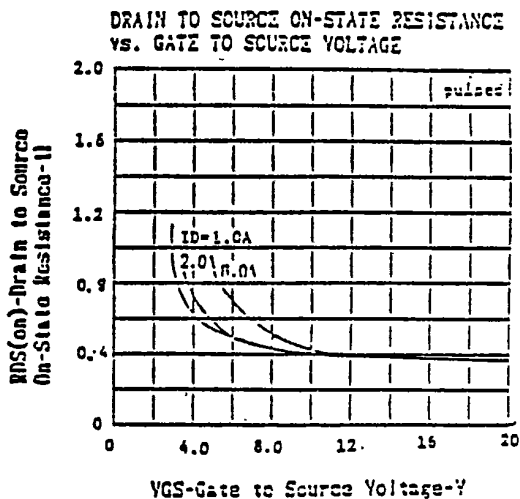
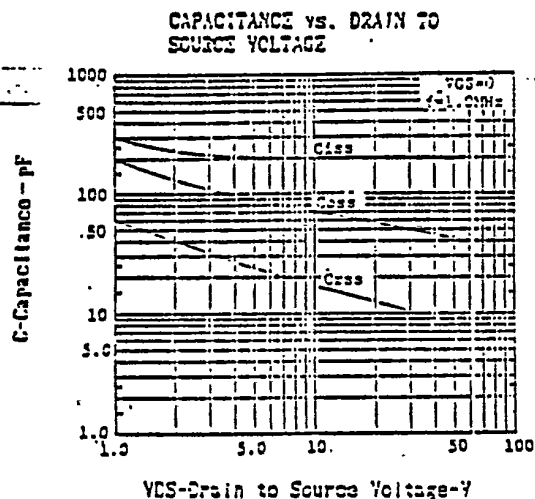
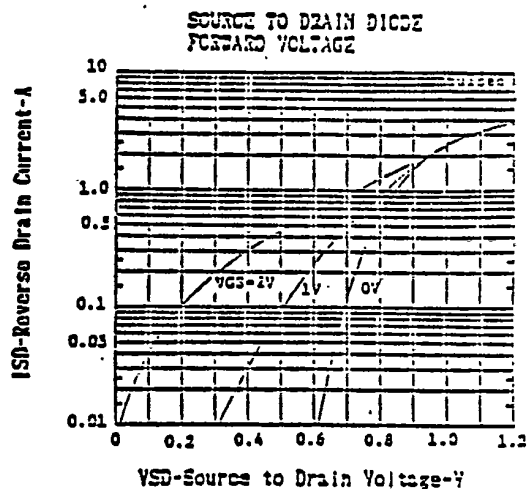
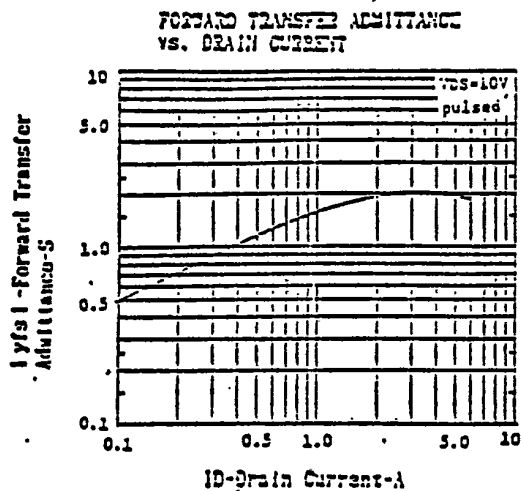

3

uPA 1.572H

NEC ELECTRONIC DEVICE

TRANSFER CHARACTERISTICS

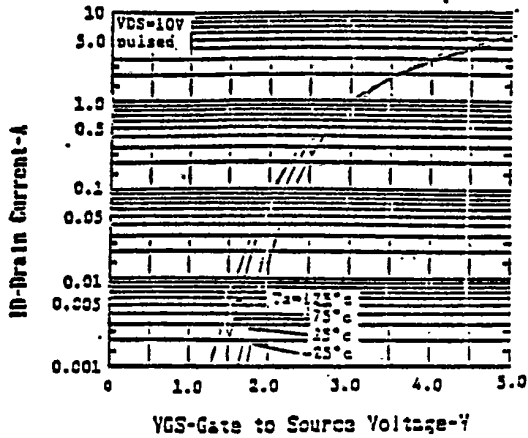

GATE TO SOURCE CUTOFF VOLTAGE VS. CHANNEL TEMPERATURE

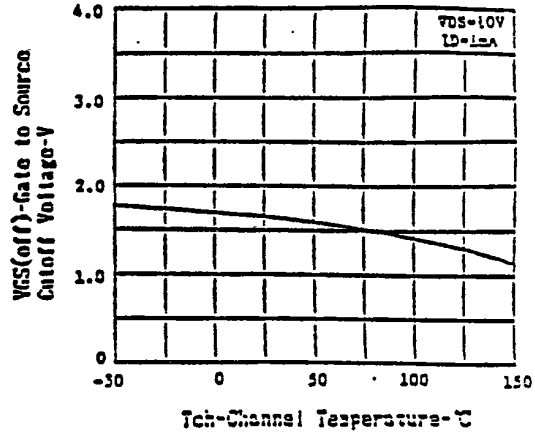

TURN-ON AND TURN-OFF TIME

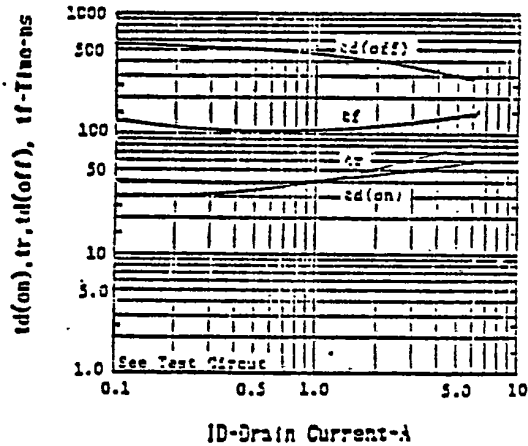

NEC Corporation

INTERNATIONAL ELECTRONIC DEVICES DIV.
 NEC Building, 33-1, Shiba Gochome
 Minato-ku, Tokyo 108, Japan
 Tel: Tokyo 454-1111
 Telex Address: NECTOX J22586
 Cable Address: MICROPHONE TOKYO