

# NTD32N06

## Power MOSFET 32 Amps, 60 Volts, N-Channel DPAK

Designed for low voltage, high speed switching applications in power supplies, converters and power motor controls and bridge circuits.

### Features

- Pb-Free Packages are Available
- Smaller Package than MTB36N06V
- Lower  $R_{DS(on)}$
- Lower  $V_{DS(on)}$
- Lower Total Gate Charge
- Lower and Tighter  $V_{SD}$
- Lower Diode Reverse Recovery Time
- Lower Reverse Recovery Stored Charge

### Typical Applications

- Power Supplies
- Converters
- Power Motor Controls
- Bridge Circuits

### MAXIMUM RATINGS ( $T_J = 25^\circ\text{C}$ unless otherwise noted)

Rating	Symbol	Value	Unit
Drain-to-Source Voltage	$V_{DSS}$	60	Vdc
Drain-to-Gate Voltage ( $R_{GS} = 10\text{ M}\Omega$ )	$V_{DGR}$	60	Vdc
Gate-to-Source Voltage, Continuous – Non-Repetitive ( $t_p \leq 10\text{ ms}$ )	$V_{GS}$ $V_{GS}$	$\pm 20$ $\pm 30$	Vdc
Drain Current	$I_D$	32	Adc
– Continuous @ $T_A = 25^\circ\text{C}$	$I_D$	22	
– Continuous @ $T_A = 100^\circ\text{C}$	$I_{DM}$	90	Apk
– Single Pulse ( $t_p \leq 10\ \mu\text{s}$ )			
Total Power Dissipation @ $T_A = 25^\circ\text{C}$ Derate above $25^\circ\text{C}$	$P_D$	93.75 0.625	W W/ $^\circ\text{C}$
Total Power Dissipation @ $T_A = 25^\circ\text{C}$ (Note 1)		2.88	W
Total Power Dissipation @ $T_A = 25^\circ\text{C}$ (Note 2)		1.5	W
Operating and Storage Temperature Range	$T_J, T_{stg}$	$-55$ to $+175$	$^\circ\text{C}$
Single Pulse Drain-to-Source Avalanche Energy – Starting $T_J = 25^\circ\text{C}$ (Note 3) ( $V_{DD} = 50\text{ Vdc}$ , $V_{GS} = 10\text{ Vdc}$ , $L = 1.0\text{ mH}$ , $I_{L(pk)} = 25\text{ A}$ , $V_{DS} = 60\text{ Vdc}$ , $R_G = 25\ \Omega$ )	$E_{AS}$	313	mJ
Thermal Resistance – Junction-to-Case – Junction-to-Ambient (Note 1) – Junction-to-Ambient (Note 2)	$R_{\theta JC}$ $R_{\theta JA}$ $R_{\theta JA}$	1.6 52 100	$^\circ\text{C/W}$
Maximum Lead Temperature for Soldering Purposes, 1/8" from case for 10 seconds	$T_L$	260	$^\circ\text{C}$

Maximum ratings are those values beyond which device damage can occur. Maximum ratings applied to the device are individual stress limit values (not normal operating conditions) and are not valid simultaneously. If these limits are exceeded, device functional operation is not implied, damage may occur and reliability may be affected.

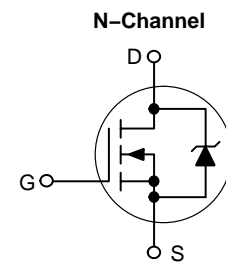
1. When surface mounted to an FR4 board using 1" pad size, (Cu Area 1.127 in<sup>2</sup>).
2. When surface mounted to an FR4 board using minimum recommended pad size, (Cu Area 0.412 in<sup>2</sup>).
3. Repetitive rating; pulse width limited by maximum junction temperature.



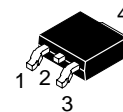
ON Semiconductor®

<http://onsemi.com>

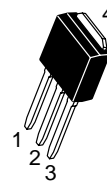
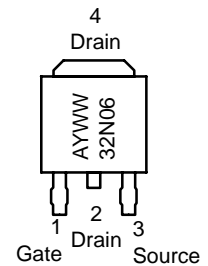
$V_{(BR)DSS}$	$R_{DS(on)}$ TYP	$I_D$ MAX
60 V	26 m $\Omega$	32 A



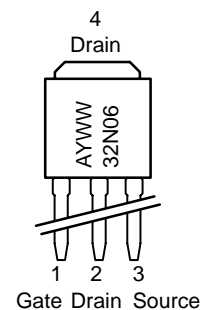
### MARKING DIAGRAMS



DPAK  
CASE 369D  
STYLE 2



DPAK-3  
CASE 369D  
STYLE 2



32N06 = Device Code  
A = Assembly Location  
Y = Year  
WW = Work Week

### ORDERING INFORMATION

See detailed ordering and shipping information in the package dimensions section on page 6 of this data sheet.

# NTD32N06

## ELECTRICAL CHARACTERISTICS (T<sub>J</sub> = 25°C unless otherwise noted)

Characteristic	Symbol	Min	Typ	Max	Unit
<b>OFF CHARACTERISTICS</b>					
Drain-to-Source Breakdown Voltage (Note 4) (V <sub>GS</sub> = 0 Vdc, I <sub>D</sub> = 250 μAdc) Temperature Coefficient (Positive)	V <sub>(BR)DSS</sub>	60 –	70 41.6	– –	Vdc mV/°C
Zero Gate Voltage Drain Current (V <sub>DS</sub> = 60 Vdc, V <sub>GS</sub> = 0 Vdc) (V <sub>DS</sub> = 60 Vdc, V <sub>GS</sub> = 0 Vdc, T <sub>J</sub> = 150°C)	I <sub>DSS</sub>	– –	– –	1.0 10	μAdc
Gate-Body Leakage Current (V <sub>GS</sub> = ±20 Vdc, V <sub>DS</sub> = 0 Vdc)	I <sub>GSS</sub>	–	–	±100	nAdc

## ON CHARACTERISTICS (Note 4)

Gate Threshold Voltage (Note 4) (V <sub>DS</sub> = V <sub>GS</sub> , I <sub>D</sub> = 250 μAdc) Threshold Temperature Coefficient (Negative)	V <sub>GS(th)</sub>	2.0 –	2.8 7.0	4.0 –	Vdc mV/°C
Static Drain-to-Source On-Resistance (Note 4) (V <sub>GS</sub> = 10 Vdc, I <sub>D</sub> = 16 Adc)	R <sub>DS(on)</sub>	–	21	26	mΩ
Static Drain-to-Source On-Voltage (Note 4) (V <sub>GS</sub> = 10 Vdc, I <sub>D</sub> = 20 Adc) (V <sub>GS</sub> = 10 Vdc, I <sub>D</sub> = 32 Adc) (V <sub>GS</sub> = 10 Vdc, I <sub>D</sub> = 16 Adc, T <sub>J</sub> = 150°C)	V <sub>DS(on)</sub>	– – –	0.417 0.680 0.633	0.62 – –	Vdc
Forward Transconductance (Note 4) (V <sub>DS</sub> = 6 Vdc, I <sub>D</sub> = 16 Adc)	g <sub>FS</sub>	–	21.1	–	mhos

## DYNAMIC CHARACTERISTICS

Input Capacitance	(V <sub>DS</sub> = 25 Vdc, V <sub>GS</sub> = 0 Vdc, f = 1.0 MHz)	C <sub>iss</sub>	–	1231	1725	pF
Output Capacitance		C <sub>oss</sub>	–	346	485	
Transfer Capacitance		C <sub>rss</sub>	–	77	160	

## SWITCHING CHARACTERISTICS (Note 5)

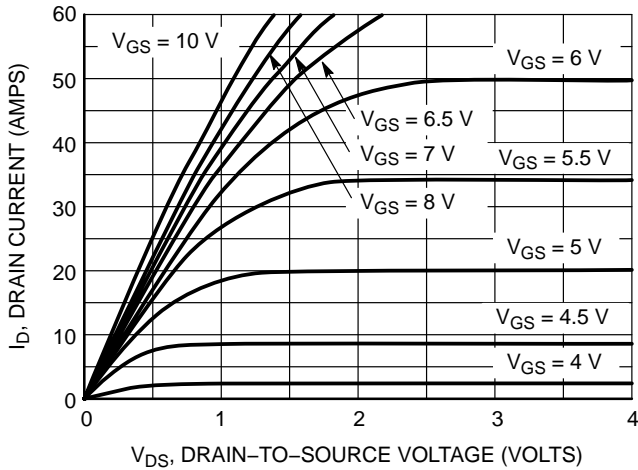
Turn-On Delay Time	(V <sub>DD</sub> = 30 Vdc, I <sub>D</sub> = 32 Adc, V <sub>GS</sub> = 10 Vdc, R <sub>G</sub> = 9.1 Ω) (Note 4)	t <sub>d(on)</sub>	–	10	25	ns
Rise Time		t <sub>r</sub>	–	84	180	
Turn-Off Delay Time		t <sub>d(off)</sub>	–	31	70	
Fall Time		t <sub>f</sub>	–	93	200	
Gate Charge	(V <sub>DS</sub> = 48 Vdc, I <sub>D</sub> = 32 Adc, V <sub>GS</sub> = 10 Vdc) (Note 4)	Q <sub>T</sub>	–	33	60	nC
		Q <sub>1</sub>	–	6.0	–	
		Q <sub>2</sub>	–	15	–	

## SOURCE-DRAIN DIODE CHARACTERISTICS

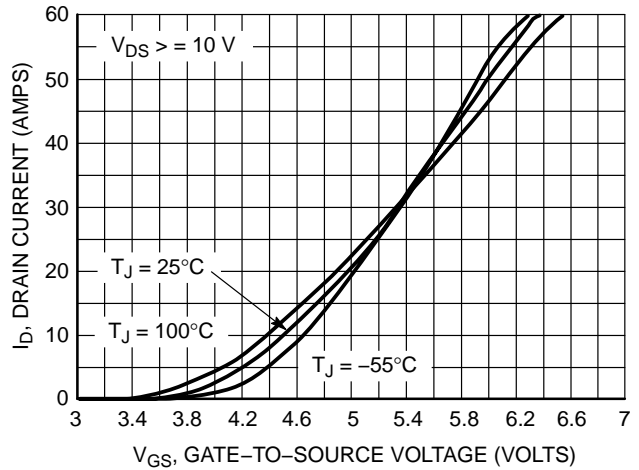
Forward On-Voltage	(I <sub>S</sub> = 20 Adc, V <sub>GS</sub> = 0 Vdc) (Note 4) (I <sub>S</sub> = 32 Adc, V <sub>GS</sub> = 0 Vdc) (Note 4) (I <sub>S</sub> = 20 Adc, V <sub>GS</sub> = 0 Vdc, T <sub>J</sub> = 150°C)	V <sub>SD</sub>	– – –	0.89 0.96 0.75	1.0 – –	Vdc
Reverse Recovery Time	(I <sub>S</sub> = 32 Adc, V <sub>GS</sub> = 0 Vdc, di <sub>S</sub> /dt = 100 A/μs) (Note 4)	t <sub>rr</sub>	–	52	–	ns
		t <sub>a</sub>	–	37	–	
		t <sub>b</sub>	–	14.3	–	
Reverse Recovery Stored Charge		Q <sub>RR</sub>	–	0.095	–	μC

- Pulse Test: Pulse Width ≤ 300 μs, Duty Cycle ≤ 2%.
- Switching characteristics are independent of operating junction temperatures.

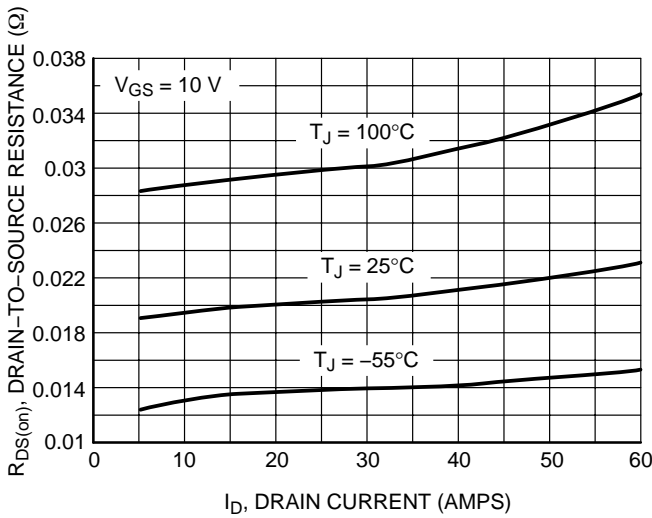
# NTD32N06



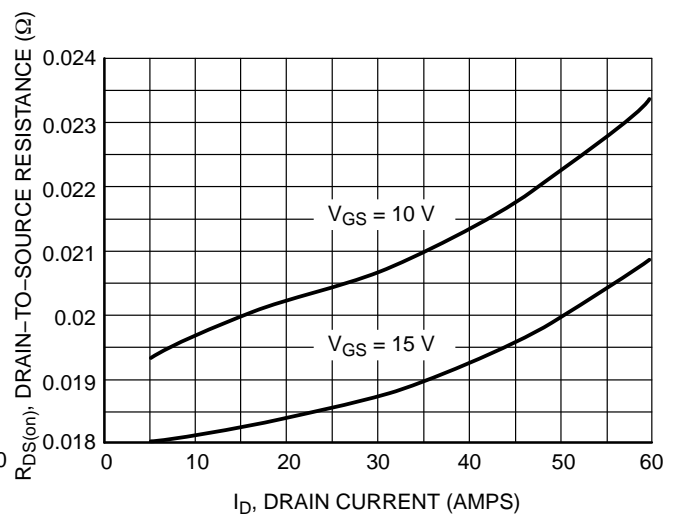
**Figure 1. On-Region Characteristics**



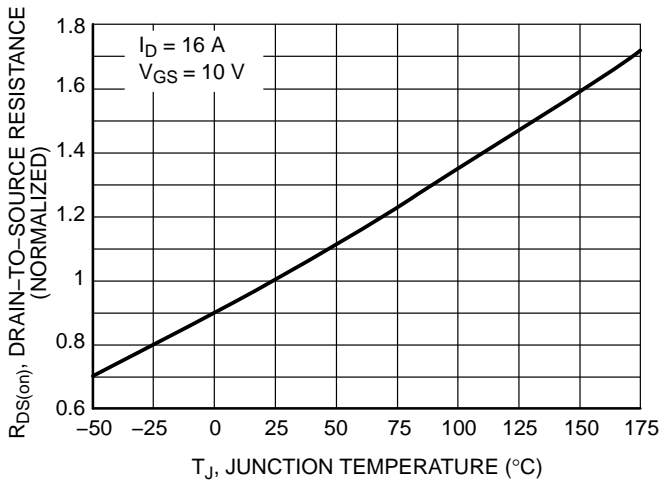
**Figure 2. Transfer Characteristics**



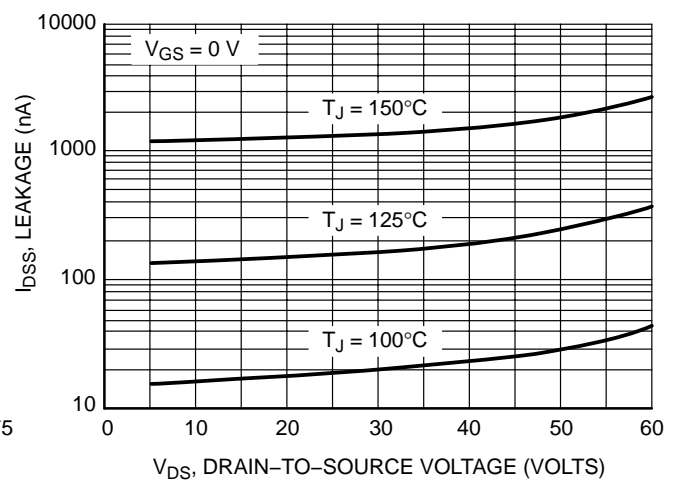
**Figure 3. On-Resistance vs. Gate-to-Source Voltage**



**Figure 4. On-Resistance vs. Drain Current and Gate Voltage**

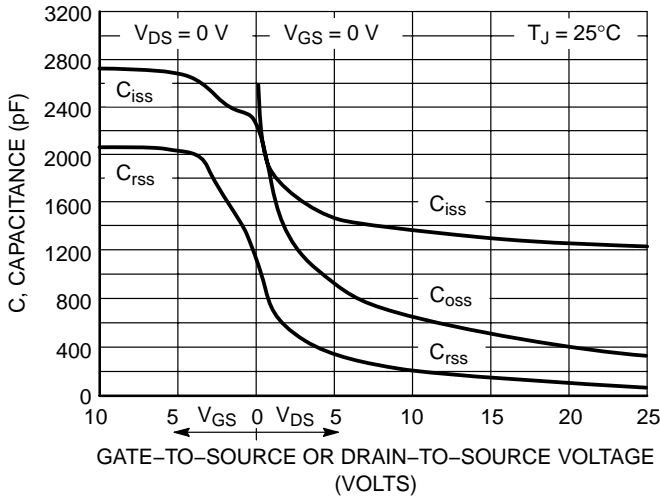


**Figure 5. On-Resistance Variation with Temperature**

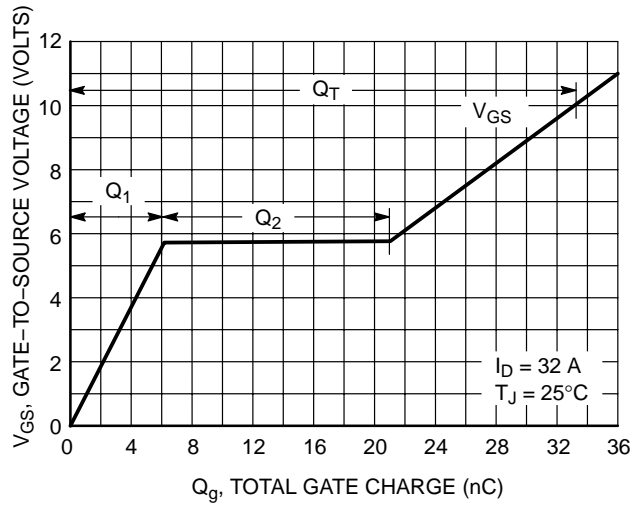


**Figure 6. Drain-to-Source Leakage Current vs. Voltage**

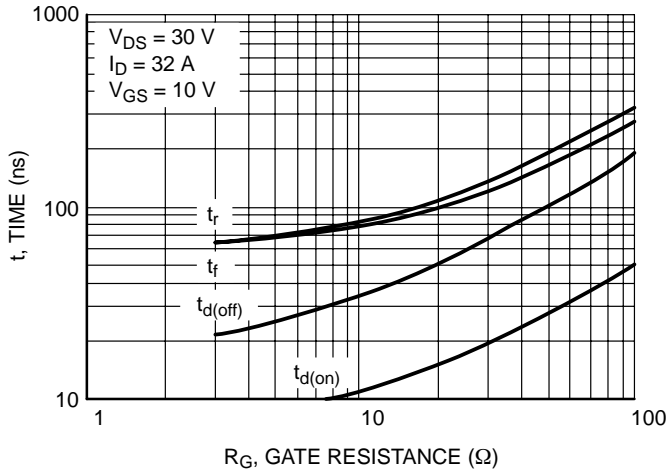
# NTD32N06



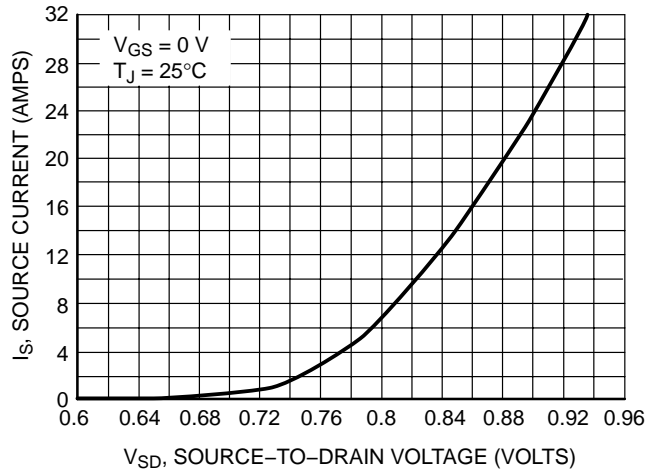
**Figure 7. Capacitance Variation**



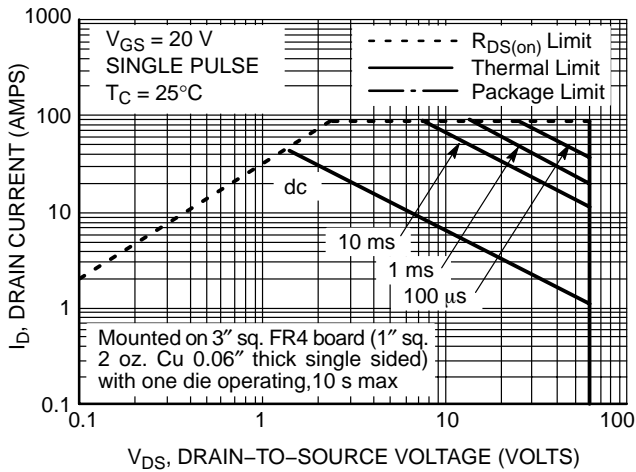
**Figure 8. Gate-to-Source and Drain-to-Source Voltage vs. Total Charge**



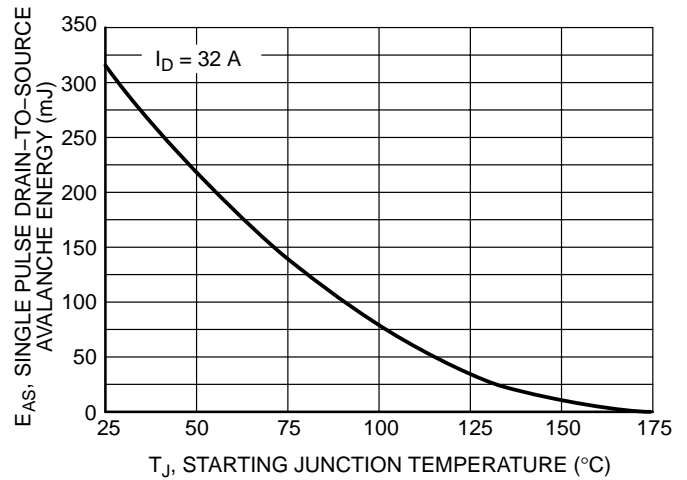
**Figure 9. Resistive Switching Time Variation vs. Gate Resistance**



**Figure 10. Diode Forward Voltage vs. Current**



**Figure 11. Maximum Rated Forward Biased Safe Operating Area**



**Figure 12. Maximum Avalanche Energy vs. Starting Junction Temperature**

# NTD32N06

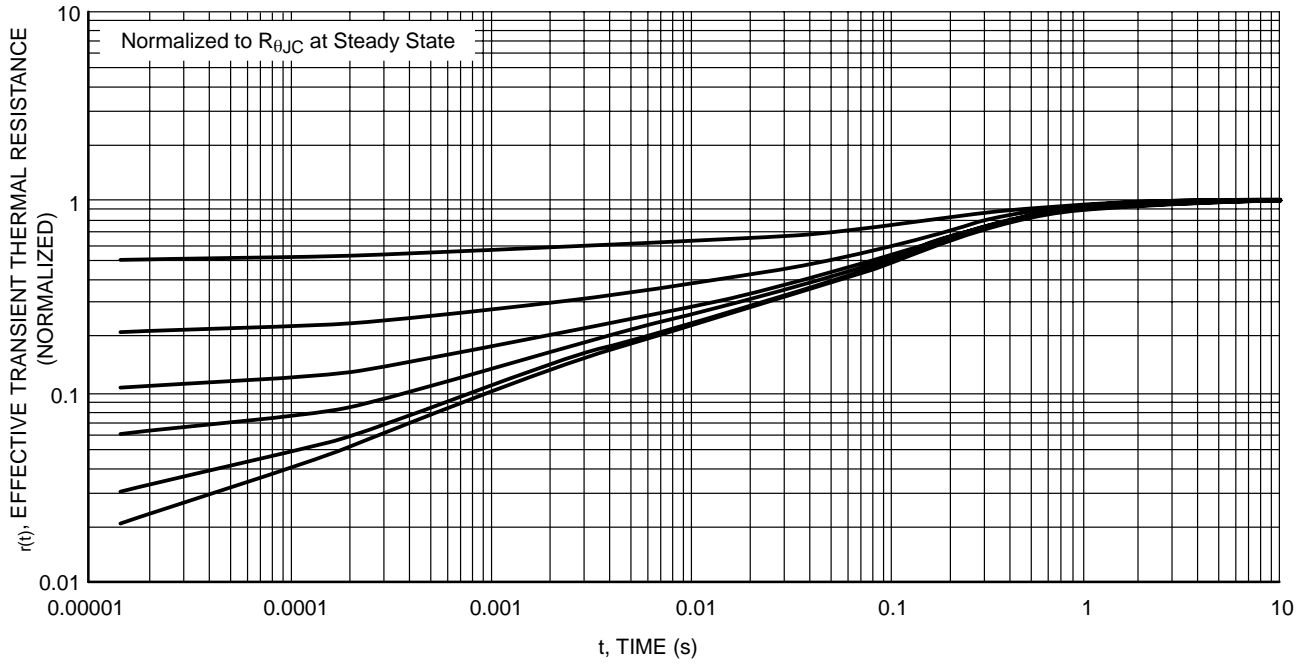


Figure 13. Thermal Response

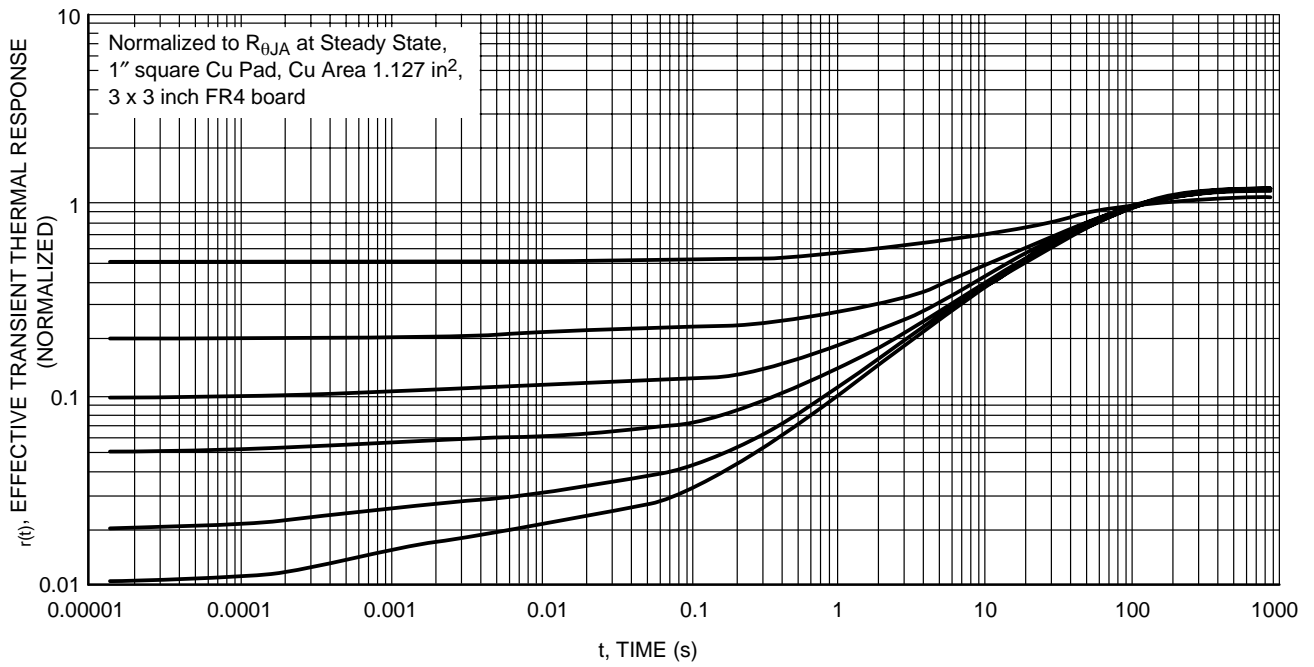


Figure 14. Thermal Response

# NTD32N06

## ORDERING INFORMATION

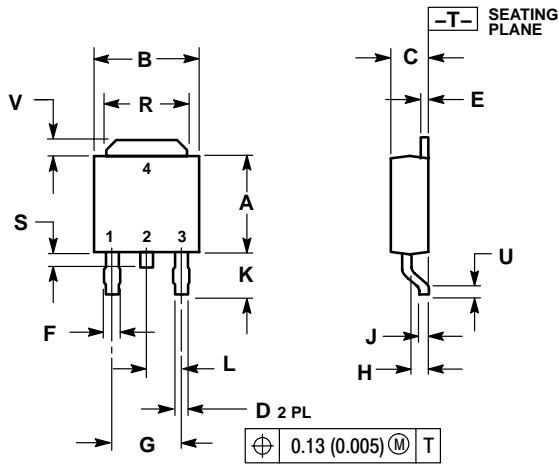
Device	Package	Shipping†
NTD32N06	DPAK	75 Units/Rail
NTD32N06G	DPAK (Pb-Free)	75 Units/Rail
NTD32N06-1	DPAK-3	75 Units/Rail
NTD32N06-1G	DPAK-3 (Pb-Free)	75 Units/Rail
NTD32N06T4	DPAK	2500 Tape & Reel
NTD32N06T4G	DPAK (Pb-Free)	2500 Tape & Reel

†For information on tape and reel specifications, including part orientation and tape sizes, please refer to our Tape and Reel Packaging Specifications Brochure, BRD8011/D.

# NTD32N06

## PACKAGE DIMENSIONS

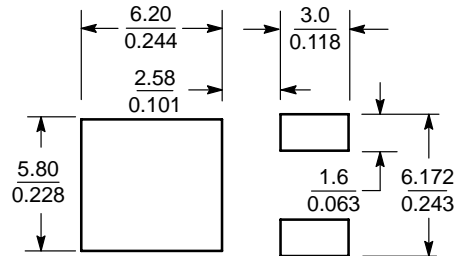
DPAK  
CASE 369C-01  
ISSUE O



DIM	INCHES		MILLIMETERS	
	MIN	MAX	MIN	MAX
A	0.235	0.245	5.97	6.22
B	0.250	0.265	6.35	6.73
C	0.086	0.094	2.19	2.38
D	0.027	0.035	0.69	0.88
E	0.018	0.023	0.46	0.58
F	0.037	0.045	0.94	1.14
G	0.180 BSC		4.58 BSC	
H	0.034	0.040	0.87	1.01
J	0.018	0.023	0.46	0.58
K	0.102	0.114	2.60	2.89
L	0.090 BSC		2.29 BSC	
R	0.180	0.215	4.57	5.45
S	0.025	0.040	0.63	1.01
U	0.020	---	0.51	---
V	0.035	0.050	0.89	1.27
Z	0.155	---	3.93	---

STYLE 2:  
PIN 1. GATE  
2. DRAIN  
3. SOURCE  
4. DRAIN

### SOLDERING FOOTPRINT\*



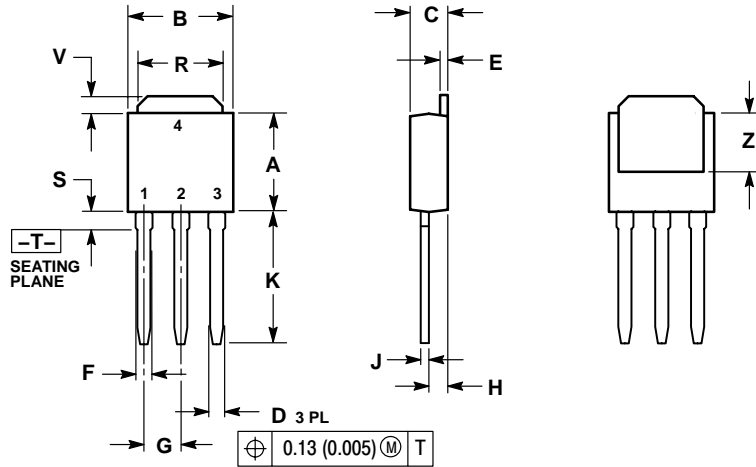
SCALE 3:1  $\left(\frac{\text{mm}}{\text{inches}}\right)$

\*For additional information on our Pb-Free strategy and soldering details, please download the ON Semiconductor Soldering and Mounting Techniques Reference Manual, SOLDERRM/D.

# NTD32N06

## PACKAGE DIMENSIONS

DPAK-3  
CASE 369D-01  
ISSUE B



NOTES:

1. DIMENSIONING AND TOLERANCING PER ANSI Y14.5M, 1982.
2. CONTROLLING DIMENSION: INCH.

DIM	INCHES		MILLIMETERS	
	MIN	MAX	MIN	MAX
A	0.235	0.245	5.97	6.35
B	0.250	0.265	6.35	6.73
C	0.086	0.094	2.19	2.38
D	0.027	0.035	0.69	0.88
E	0.018	0.023	0.46	0.58
F	0.037	0.045	0.94	1.14
G	0.090 BSC		2.29 BSC	
H	0.034	0.040	0.87	1.01
J	0.018	0.023	0.46	0.58
K	0.350	0.380	8.89	9.65
R	0.180	0.215	4.45	5.45
S	0.025	0.040	0.63	1.01
V	0.035	0.050	0.89	1.27
Z	0.155	---	3.93	---

STYLE 2:

- PIN 1. GATE  
2. DRAIN  
3. SOURCE  
4. DRAIN

ON Semiconductor and are registered trademarks of Semiconductor Components Industries, LLC (SCILLC). SCILLC reserves the right to make changes without further notice to any products herein. SCILLC makes no warranty, representation or guarantee regarding the suitability of its products for any particular purpose, nor does SCILLC assume any liability arising out of the application or use of any product or circuit, and specifically disclaims any and all liability, including without limitation special, consequential or incidental damages. "Typical" parameters which may be provided in SCILLC data sheets and/or specifications can and do vary in different applications and actual performance may vary over time. All operating parameters, including "Typicals" must be validated for each customer application by customer's technical experts. SCILLC does not convey any license under its patent rights nor the rights of others. SCILLC products are not designed, intended, or authorized for use as components in systems intended for surgical implant into the body, or other applications intended to support or sustain life, or for any other application in which the failure of the SCILLC product could create a situation where personal injury or death may occur. Should Buyer purchase or use SCILLC products for any such unintended or unauthorized application, Buyer shall indemnify and hold SCILLC and its officers, employees, subsidiaries, affiliates, and distributors harmless against all claims, costs, damages, and expenses, and reasonable attorney fees arising out of, directly or indirectly, any claim of personal injury or death associated with such unintended or unauthorized use, even if such claim alleges that SCILLC was negligent regarding the design or manufacture of the part. SCILLC is an Equal Opportunity/Affirmative Action Employer. This literature is subject to all applicable copyright laws and is not for resale in any manner.

### PUBLICATION ORDERING INFORMATION

**LITERATURE FULFILLMENT:**

Literature Distribution Center for ON Semiconductor  
P.O. Box 61312, Phoenix, Arizona 85082-1312 USA  
**Phone:** 480-829-7710 or 800-344-3860 Toll Free USA/Canada  
**Fax:** 480-829-7709 or 800-344-3867 Toll Free USA/Canada  
**Email:** orderlit@onsemi.com

**N. American Technical Support:** 800-282-9855 Toll Free USA/Canada

**Japan:** ON Semiconductor, Japan Customer Focus Center  
2-9-1 Kamimeguro, Meguro-ku, Tokyo, Japan 153-0051  
**Phone:** 81-3-5773-3850

**ON Semiconductor Website:** <http://onsemi.com>

**Order Literature:** <http://www.onsemi.com/litorder>

For additional information, please contact your local Sales Representative.