



# TIG032TS — N-Channel IGBT

## Light-Controlling Flash Applications

### Features

- Low-saturation voltage.
- Low voltage drive (2.5V).
- Enhancement type.
- Built-in Gate-to-Emitter protection diode.
- Mounting Height 1.1mm, Mounting Area 19.2mm<sup>2</sup>.
- dv / dt guarantee.\*

### Specifications

#### Absolute Maximum Ratings at Ta=25°C

Parameter	Symbol	Conditions	Ratings	Unit
Collector-to-Emitter Voltage	V <sub>CES</sub>		400	V
Gate-to-Emitter Voltage (DC)	V <sub>GES</sub>		±6	V
Gate-to-Emitter Voltage (Pulse)	V <sub>GES</sub>	PW≤1ms	±8	V
Collector Current (Pulse)	I <sub>CP1</sub>	PW≤500μs, duty cycle≤0.5%, C <sub>M</sub> =400μF, V <sub>GE</sub> =2.5V	150	A
	I <sub>CP2</sub>	PW≤500μs, duty cycle≤0.5%, C <sub>M</sub> =400μF, V <sub>GE</sub> =4V	180	A
Maximum Collector-to-Emitter dv / dt	dV <sub>CE</sub> / dt	V <sub>CE</sub> ≤320V, starting Tch=25°C	400	V / μs
Channel Temperature	T <sub>ch</sub>		150	°C
Storage Temperature	T <sub>stg</sub>		-40 to +150	°C

#### Electrical Characteristics at Ta=25°C

Parameter	Symbol	Conditions	Ratings			Unit
			min	typ	max	
Collector-to-Emitter Breakdown Voltage	V <sub>(BR)CES</sub>	I <sub>C</sub> =2mA, V <sub>GE</sub> =0V	400			V
Collector-to-Emitter Cutoff Current	I <sub>CES</sub>	V <sub>CE</sub> =320V, V <sub>GE</sub> =0V			10	μA
Gate-to-Emitter Leakage Current	I <sub>GES</sub>	V <sub>GE</sub> =±6V, V <sub>CE</sub> =0V			±10	μA

Marking : G032

Continued on next page.

\* : Conduct 100% screening of dv / dt (slope of collector voltage at the time of turn-off) by dv / dt&gt;400V/μs.

- Any and all SANYO Semiconductor Co.,Ltd. products described or contained herein are, with regard to "standard application", intended for the use as general electronics equipment (home appliances, AV equipment, communication device, office equipment, industrial equipment etc.). The products mentioned herein shall not be intended for use for any "special application" (medical equipment whose purpose is to sustain life, aerospace instrument, nuclear control device, burning appliances, transportation machine, traffic signal system, safety equipment etc.) that shall require extremely high level of reliability and can directly threaten human lives in case of failure or malfunction of the product or may cause harm to human bodies, nor shall they grant any guarantee thereof. If you should intend to use our products for applications outside the standard applications of our customer who is considering such use and/or outside the scope of our intended standard applications, please consult with us prior to the intended use. If there is no consultation or inquiry before the intended use, our customer shall be solely responsible for the use.
- Specifications of any and all SANYO Semiconductor Co.,Ltd. products described or contained herein stipulate the performance, characteristics, and functions of the described products in the independent state, and are not guarantees of the performance, characteristics, and functions of the described products as mounted in the customer's products or equipment. To verify symptoms and states that cannot be evaluated in an independent device, the customer should always evaluate and test devices mounted in the customer's products or equipment.

# TIG032TS

Continued from preceding page.

Parameter	Symbol	Conditions	Ratings			Unit
			min	typ	max	
Gate-to-Emitter Threshold Voltage	$V_{GE(off)}$	$V_{CE}=10V, I_C=1mA$	0.4		1.0	V
Collector-to-Emitter Saturation Voltage	$V_{CE(sat)1}$	$I_C=150A, V_{GE}=2.5V$		3.4	4.8	V
	$V_{CE(sat)2}$	$I_C=180A, V_{GE}=4V$		3.3	4.7	V
Input Capacitance	$C_{ies}$	$V_{CE}=10V, f=1MHz$		5100		pF
Output Capacitance	$C_{oes}$	$V_{CE}=10V, f=1MHz$		59		pF
Reverse Transfer Capacitance	$C_{res}$	$V_{CE}=10V, f=1MHz$		43		pF

## Package Dimensions

unit : mm (typ)  
7006A-007

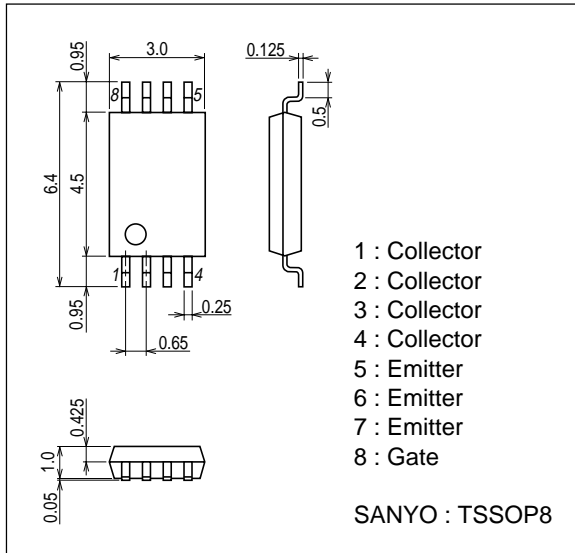

## Electrical Connection

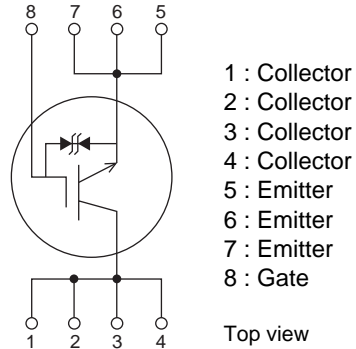

## Large Current R Load Screening Circuit

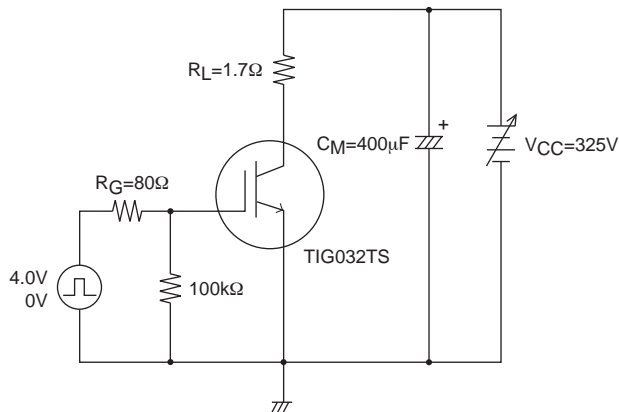

Note1. Gate Series Resistance  $R_G \geq 47\Omega$  is recommended for protection purpose at the time of turn OFF. However, if  $dv/dt \leq 400V/\mu s$  is satisfied at customer's actual set evaluation,  $R_G < 47\Omega$  can also be used.

Note2. The collector voltage gradient  $dv/dt$  must be smaller than  $400V/\mu s$  to protect the device when it is turned off.

# TIG032TS

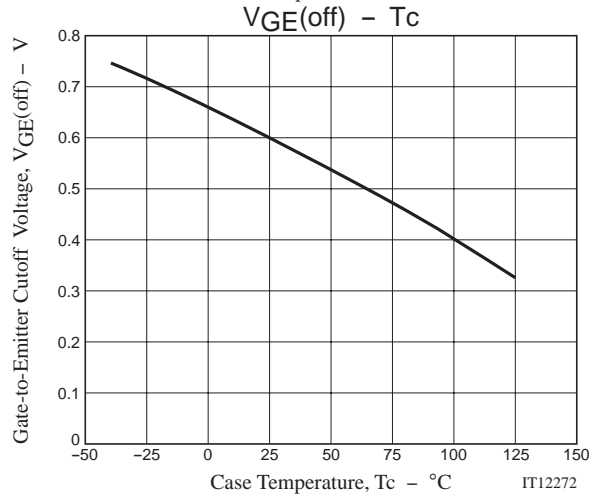
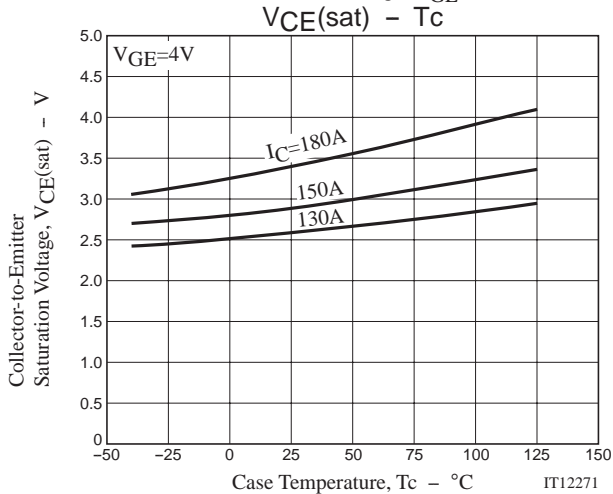
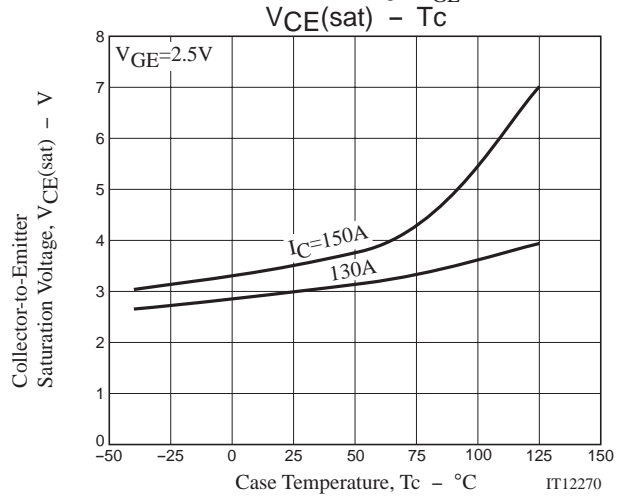
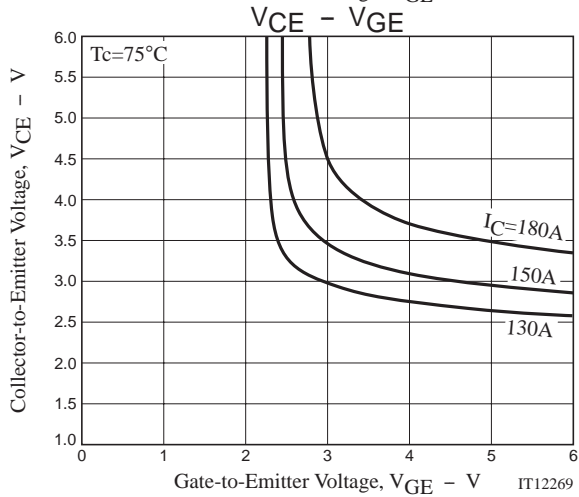
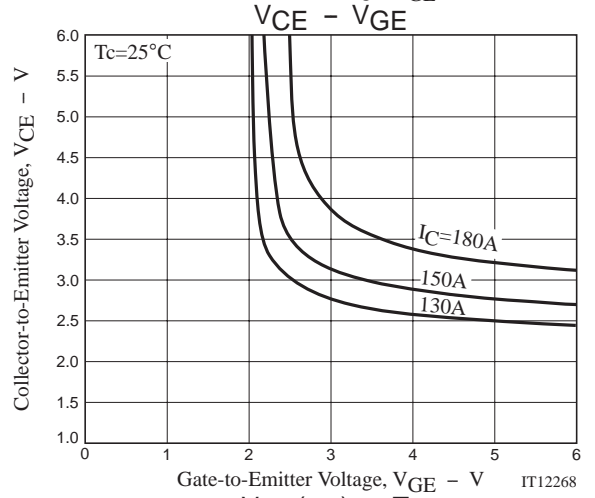
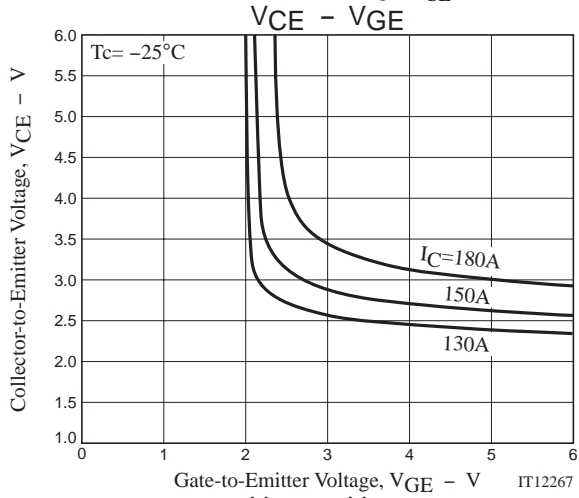
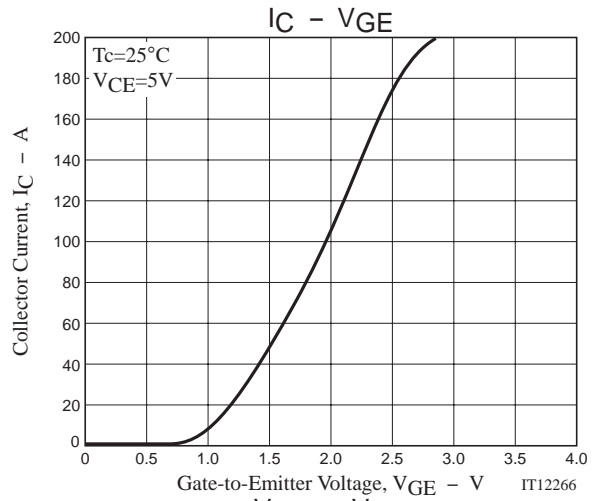
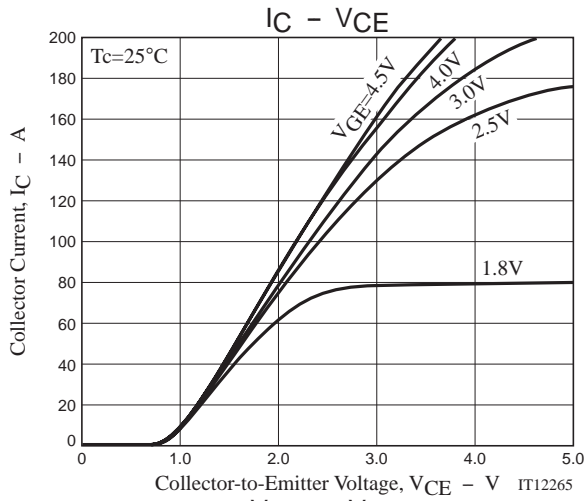

# TIG032TS

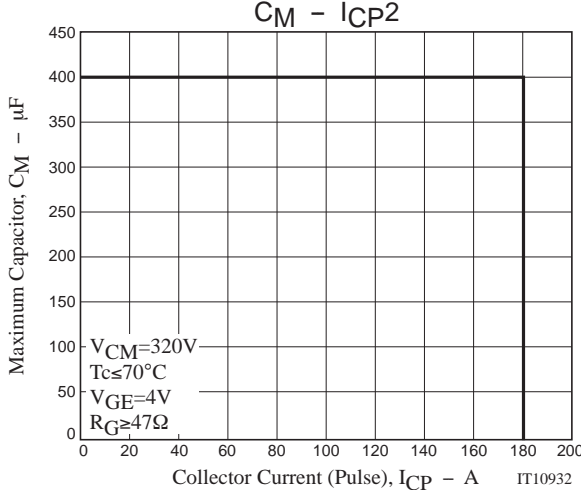
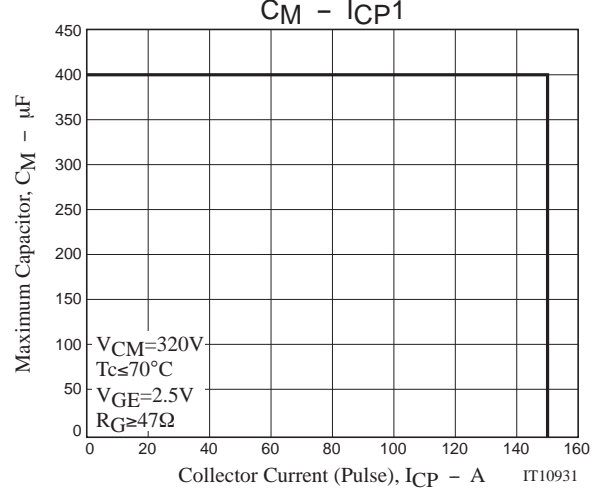
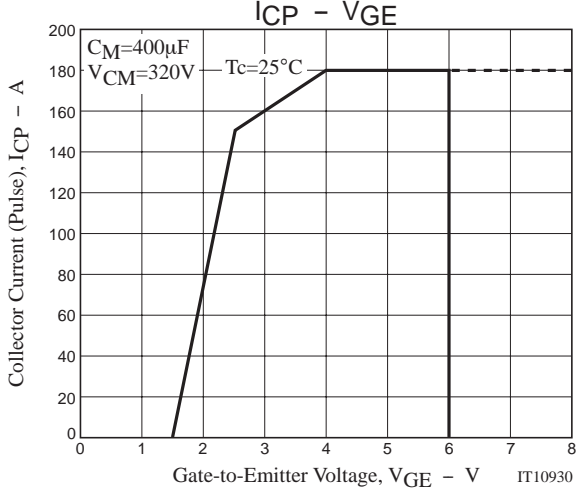
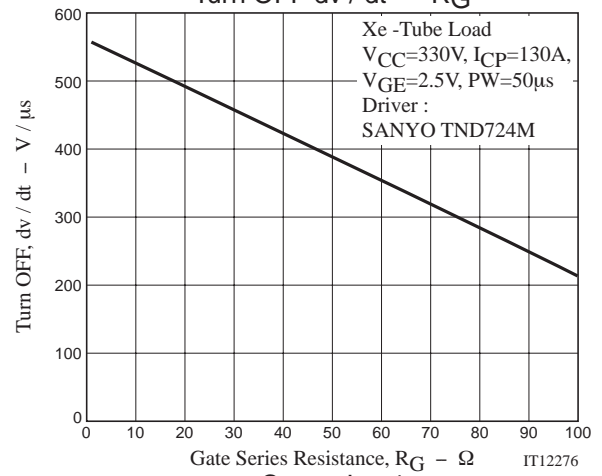
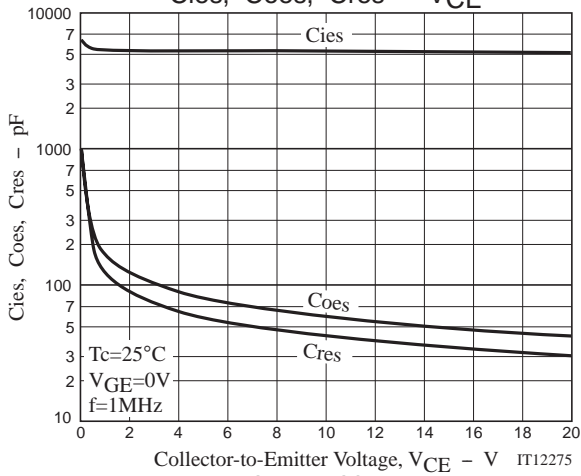
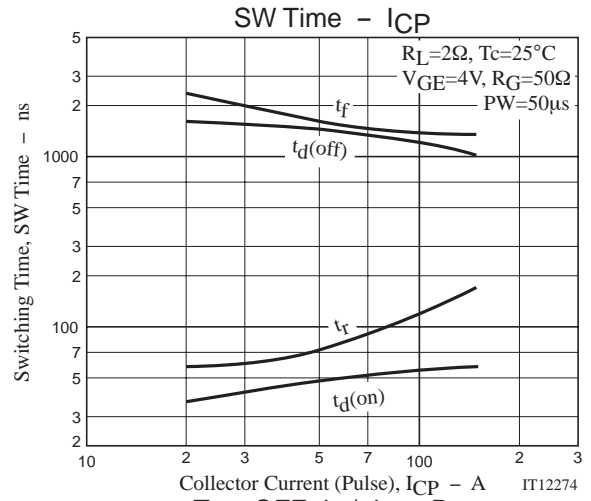
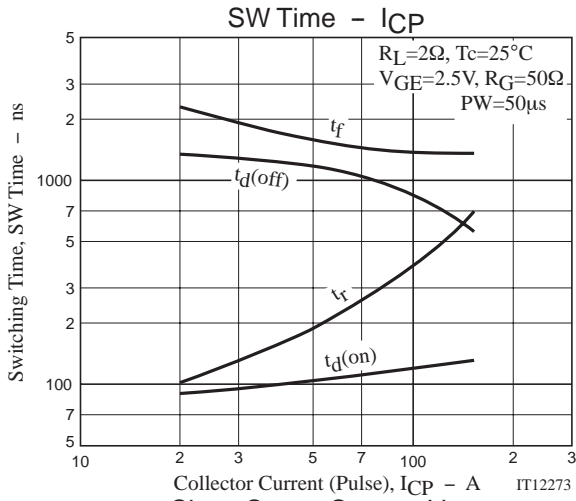

Note : TIG032TS has protection diode between gate and emitter but handling it requires sufficient care to be taken.

- SANYO Semiconductor Co.,Ltd. assumes no responsibility for equipment failures that result from using products at values that exceed, even momentarily, rated values (such as maximum ratings, operating condition ranges, or other parameters) listed in products specifications of any and all SANYO Semiconductor Co.,Ltd. products described or contained herein.
- SANYO Semiconductor Co.,Ltd. strives to supply high-quality high-reliability products, however, any and all semiconductor products fail or malfunction with some probability. It is possible that these probabilistic failures or malfunction could give rise to accidents or events that could endanger human lives, trouble that could give rise to smoke or fire, or accidents that could cause damage to other property. When designing equipment, adopt safety measures so that these kinds of accidents or events cannot occur. Such measures include but are not limited to protective circuits and error prevention circuits for safe design, redundant design, and structural design.
- In the event that any or all SANYO Semiconductor Co.,Ltd. products described or contained herein are controlled under any of applicable local export control laws and regulations, such products may require the export license from the authorities concerned in accordance with the above law.
- No part of this publication may be reproduced or transmitted in any form or by any means, electronic or mechanical, including photocopying and recording, or any information storage or retrieval system, or otherwise, without the prior written consent of SANYO Semiconductor Co.,Ltd.
- Any and all information described or contained herein are subject to change without notice due to product/technology improvement, etc. When designing equipment, refer to the "Delivery Specification" for the SANYO Semiconductor Co.,Ltd. product that you intend to use.
- Information (including circuit diagrams and circuit parameters) herein is for example only; it is not guaranteed for volume production.
- Upon using the technical information or products described herein, neither warranty nor license shall be granted with regard to intellectual property rights or any other rights of SANYO Semiconductor Co.,Ltd. or any third party. SANYO Semiconductor Co.,Ltd. shall not be liable for any claim or suits with regard to a third party's intellectual property rights which has resulted from the use of the technical information and products mentioned above.

This catalog provides information as of April, 2007. Specifications and information herein are subject to change without notice.