



The Future of Analog IC Technology™

EV7720DS-7782-00D

150W Class D

5.1 Channel Audio Board

EVALUATION BOARD

GENERAL DESCRIPTION

The EV7720DS-7782-00D is an evaluation board for using MPS' Class D Audio Amplifiers in 5.1 Surround Sound systems. The board has 150W total output power coming from 5 x 20W from the satellites (MP7720DS) and 50W from the subwoofer (MP7782). The system offers high dynamic range and low distortion for high quality sound reproduction.

FEATURES

- 150W Total Output Power
- High Fidelity
- High Efficiency
- 9.5V to 24V Supply Voltage Range
- Mute/Standby Modes
- Thermal Protection
- Over-Current Protection

APPLICATIONS

- 5.1 Audio Setups
- Home Theatre Systems

"MPS" and "The Future of Analog IC Technology", are Trademarks of Monolithic Power Systems, Inc.

ADAM (Analog Digital Adaptive Modulation) and AAM (Analog Adaptive Modulation) are Trademarks of Monolithic Power Systems, Inc.

EV7720DS-7782-00D EVALUATION BOARD

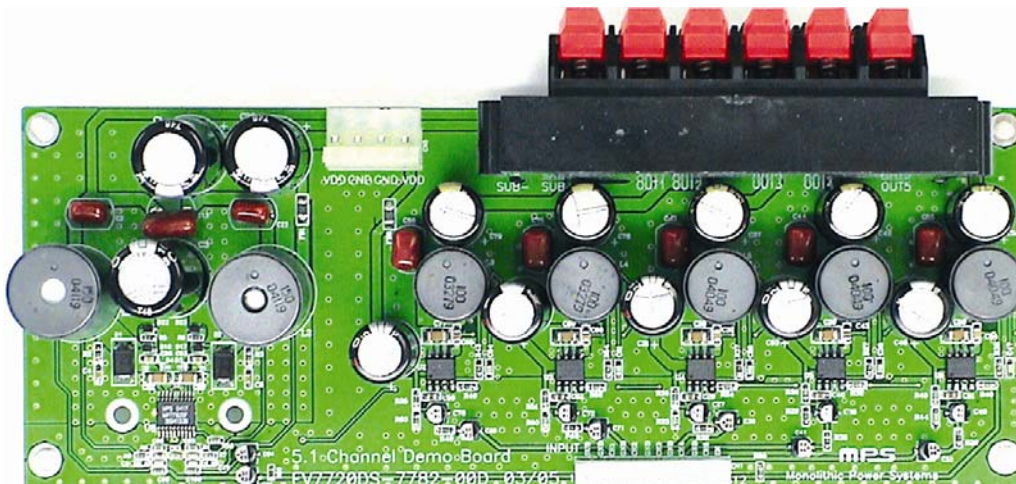

Dimensions (6.7"X x 2.5"Y)

Board Number	MPS IC Number
MP7720DS-7782-00D	5 x MP7720DS 1 x MP7782

EVALUATION BOARD SCHEMATIC

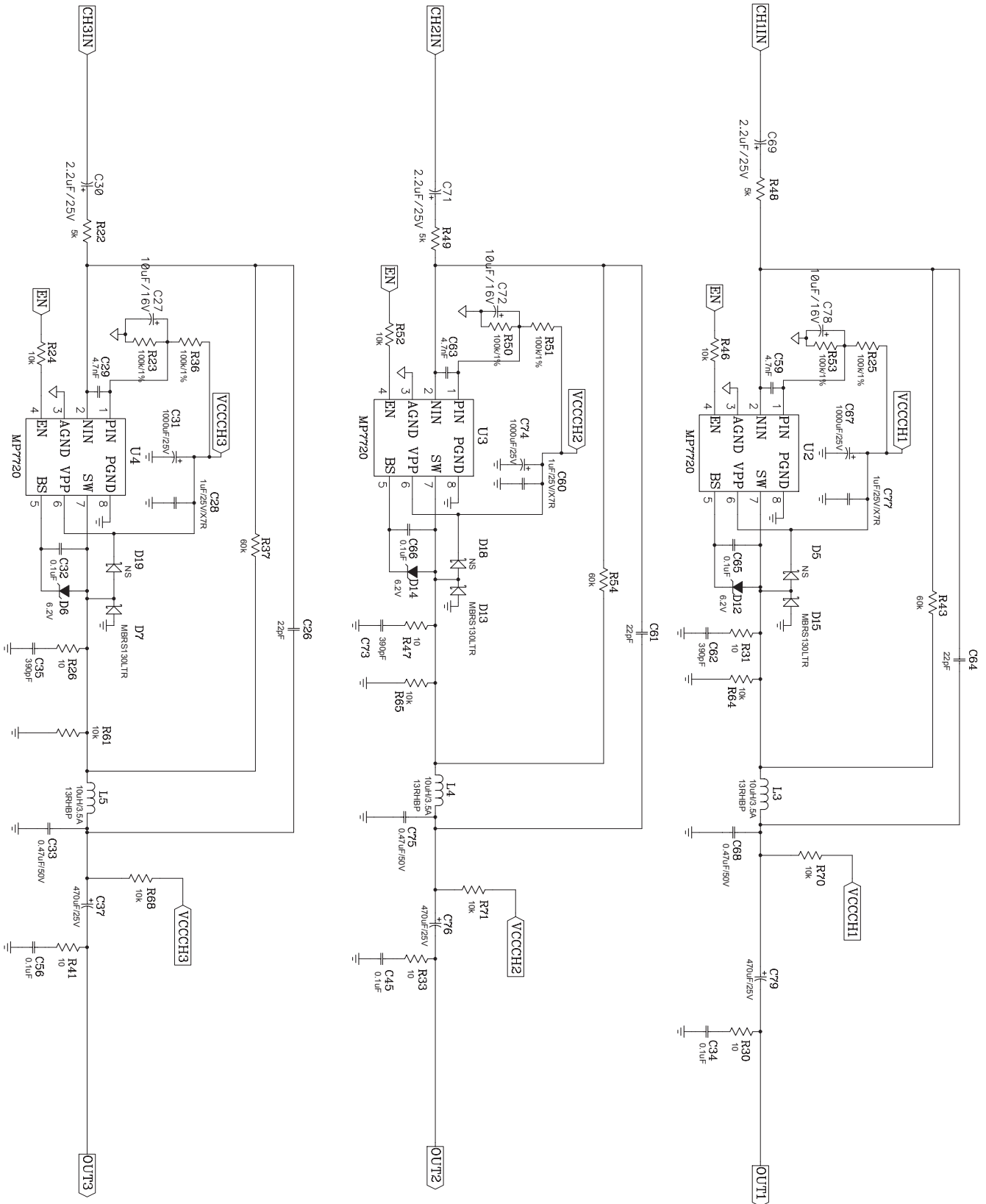

EVALUATION BOARD SCHEMATIC (continued)

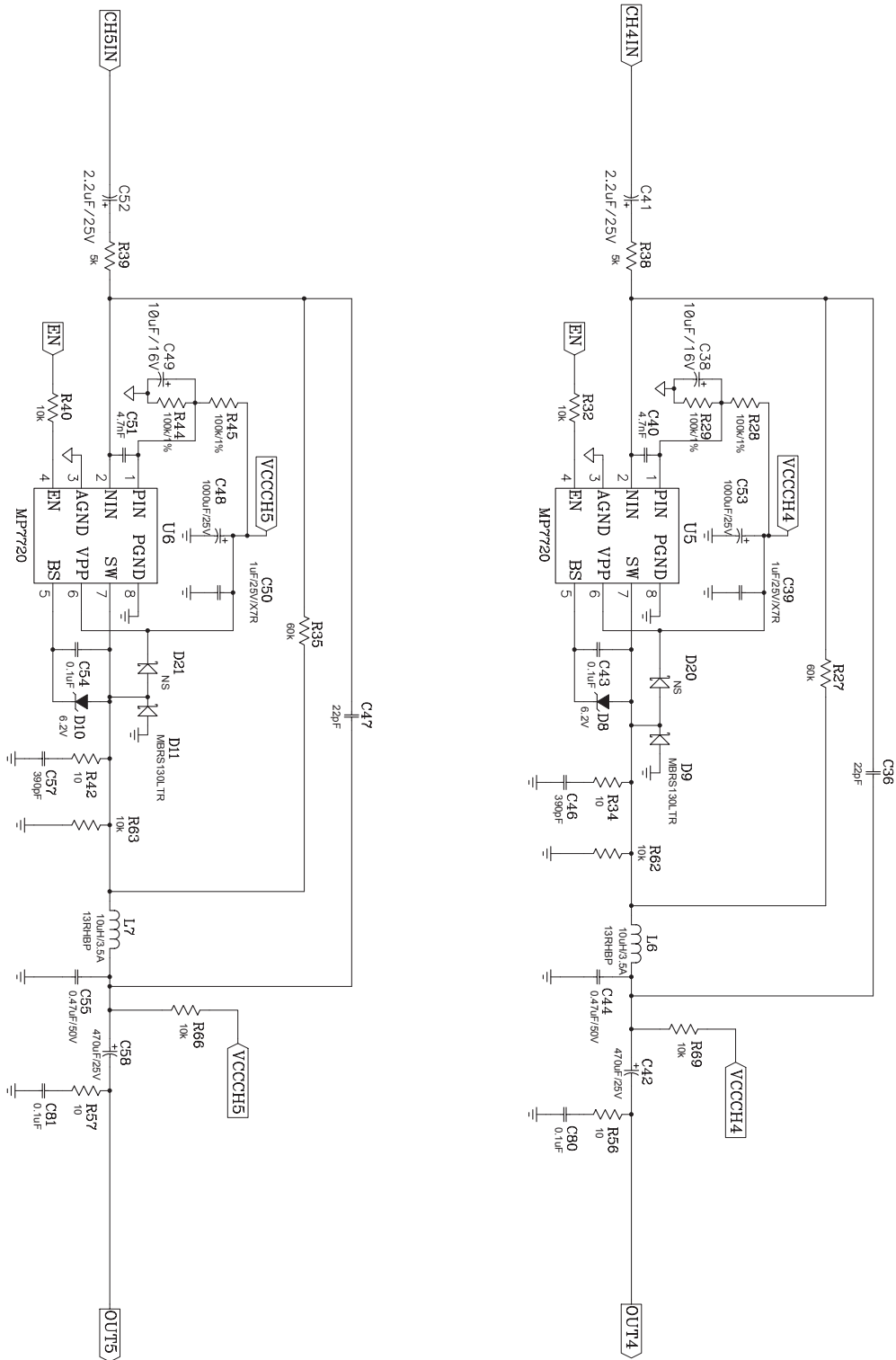

EV7720DS-7782-00D BILL OF MATERIALS

Qty	Ref	Value	Description	Package	Manufacturer: Manufacturer P/N	Distributor: Distributor P/N
3	C1, C3, C20	1000 μ F	Electrolytic Cap, 35V, NHG	Radial	Panasonic: ECA-1VHG102	Digikey: P5555-ND
2	C2, C22	0.22 μ F	Film Cap, 50V	Radial	Panasonic: ECQ-V1H224JL	Digikey: P4667-ND
7	C4, C6, C35, C46, C57, C62, C73	390pF	Ceramic Cap, 50V, X7R	SM0805	Panasonic: ECU-V1H391KBN	Digikey: PCC391BNCT-ND
7	C5, C23, C34, C45, C56, C80, C81	0.1 μ F	Ceramic Cap, 50V, X7R	SM1206	Panasonic: ECJ-3VB1H104K	Digikey: PCC104BCT-ND
2	C9, C19		Not Stuffed	SM0603		
1	C13	0.47 μ F	Film Cap, 63V	Radial	Panasonic: ECQ-V1J474JM	Digikey: P4544-ND
7	C25, C84, C69, C71, C30, C41, C52	2.2 μ F	Electrolytic Cap, 35V	SMD	Panasonic: ECE-V1VS2R2SR	Digikey: PCE3070CT-ND
5	C26, C36, C47, C61, C64	22pF	Ceramic Cap, 50V, NPO	SM0805	Panasonic: ECJ-2VC1H220J	Digikey: PCC220CNCT-ND
5	C27, C38, C49, C72, C78	10 μ F	Electrolytic Cap, 16V	SMD	Panasonic: ECE-V1CS100SR	Digikey: PCE3061CT-ND
7	C28, C39, C50, C60, C77, C82, C89	1 μ F	Ceramic Cap, 25V, X7R	SM1206	Panasonic: ECJ-3YB1E105K	Digikey: PCC1893CT-ND
5	C29, C40, C51, C59, C63	4.7nF	Ceramic Cap, 50V, X7R	SM0805	Panasonic: ECJ-2VB1H472K	Digikey: PCC472BNCT-ND
5	C31, C48, C53, C67, C74	1000 μ F	Electrolytic Cap, 25V, NHG	Radial	Panasonic: ECA-1EHG102	Digikey: P5544-ND
5	C32, C43, C54, C65, C66	0.1 μ F	Ceramic Cap, 50V, X7R	SM0805	Panasonic: ECJ-2YB1H104K	Digikey: PCC1840CT-ND
5	C33, C44, C55, C68, C75	0.47 μ F	Film Cap, 50V	Radial	Panasonic: ECQ-V1H474JL	Digikey: P4671-ND
5	C37, C42, C58, C76, C79	470 μ F	Electrolytic Cap, 25V, NHG	Radial	Panasonic: ECA-1EHG471	Digikey: P5543-ND
1	C83	1nF	Ceramic Cap, 50V, X7R	SM0603	Panasonic: ECJ-1VB1H102K	Digikey: PCC1772CT-ND
2	C86, C93	1 μ F	Ceramic Cap, 16V, X5R	SM0805	Panasonic: ECJ-2FB1C105K	Digikey: PCC2249CT-ND

EV7720DS-7782-00D BILL OF MATERIALS (continued)

Qty	Ref	Value	Description	Package	Manufacturer: Manufacturer P/N	Distributor: Distributor P/N
2	C95, C96	2pF	Ceramic Cap, 50V, NPO	SM0603	Panasonic: ECJ-1VC1H020C	Digikey: PCC020CVCT-ND
2	C98, C100	15pF	Ceramic Cap, 50V, NPO	SM0603	Panasonic: ECJ-1VC1H150J	Digikey: PCC150ACVCT-ND
1	CN1		Connector, 12-Pin Header, 2mm		Hirose Electronic: DF3-12P-2DSA(01)	Digikey: H3931-ND
1	CN2		Speaker Terminal, 6- Channel			
7	D1, D2, D15, D13, D7, D9, D11		Schottky Diode, 30V, 1A	SMB	IRF: MBRS130LTR	Digikey: MBRS130LCT-ND
7	D3, D4, D5, D18, D19, D20, D21		Not Stuffed			
5	D6, D8, D10, D12, D14		Zener Diode, 6.2V, 500mW	SOD-123	Diodes Inc: BZT52C6V2-7	Digikey: BZT52C6V2-7DICT-ND
2	D16, D17		Zener Diode, 6.2V, 200mW	SOD-323	Diodes Inc: BZT52C6V2S-7	Digikey: BZT52C6V2SDICT-ND
2	D22, D23		Switch Diode, 75V, 200mW	SOD323	Diodes Inc: 1N4148WS-7	Digikey: 1N4148WSDICT-ND
6	FB1, FB2, FB3, FB4, FB5, FB6		Ferrite Bead, 6A, 100MHz	SM1206	Steward: HI1206T500R-00	Digikey: 240-1009-1-ND
1	J1		Connector, 4-Pin		Molex: 26-48-1045	Digikey: WM4602-ND
2	L1, L2	10 μ H	Inductor, 3.61A, 13RHBP	Radial	Toko: A7502HY-100M	
5	L3, L4, L5, L6, L7	10 μ H	Inductor, 3.5A, 10RYTL	Radial	Toko: 7023LYF-100K	
2	R1, R8	100k Ω	Resistor, 1%	SM0603	Panasonic: ERJ-3EKF1003V	Digikey: P100KHCT-ND
7	R2, R3, R26, R31, R34, R42, R47	10 Ω	Resistor, 5%	SM0805	Panasonic: ERJ-6GEYJ100V	Digikey: P10ACT-ND
7	R4, R18, R30, R33, R41, R56, R57	10 Ω	Resistor, 5%	SM1206	Panasonic: ERJ-8GEYJ100V	Digikey: P10ECT-ND
2	R5, R6	20k Ω	Resistor, 5%	SM0603	Panasonic: ERJ-3GEYJ203V	Digikey: P20KGCT-ND
2	R7, R9	150k Ω	Resistor, 1%	SM0603	Panasonic: ERJ-3EKF1503V	Digikey: P150KHCT-ND

EV7720DS-7782-00D BILL OF MATERIALS (continued)

Qty	Ref	Value	Description	Package	Manufacturer: Manufacturer P/N	Distributor: Distributor P/N
2	R20, R11	10kΩ	Resistor, 1%	SM0603	Panasonic: ERJ-3EKF1002V	Digikey: P10.0KHCT-ND
11	R23, R25, R28, R29, R36, R44, R45, R50, R51, R53, R55	100kΩ	Resistor, 1%	SM0805	Panasonic: ERJ-6ENF1003V	Digikey: P100KCCT-ND
5	R27, R35, R37, R43, R54	60.4kΩ	Resistor, 1%	SM0805	Panasonic: ERJ-6ENF6042V	Digikey: P60.4KCCT-ND
5	R48, R49, R22, R38, R39	5.1kΩ	Resistor, 5%	SM0805	Panasonic: ERJ-6GEYJ512V	Digikey: P5.1KACT-ND
6	R58, R46, R52, R24, R32, R40	10kΩ	Resistor, 5%	SM0805	Panasonic: ERJ-6GEYJ103V	Digikey: P10KACT-ND
1	R59		Not Stuffed	SM0603		
1	R59	5.1kΩ	Resistor, 5%	SM0603	Panasonic: ERJ-3GEYJ512V	Digikey: P5.1KGCT-ND
10	R61, R62, R63, R64, R65, R66, R68, R69, R70, R71	10kΩ	Resistor, 5%	SM1206	Panasonic: ERJ-8GEYJ103V	Digikey: P10KECT-ND
1	U1		Class D Amplifier, 40W	TSSOP20	MPS: MP7782DF	
5	U2, U3, U4, U5, U6		Class D Amplifier, 20W	SO8	MPS: MP7720DS	

PRINTED CIRCUIT BOARD LAYOUT

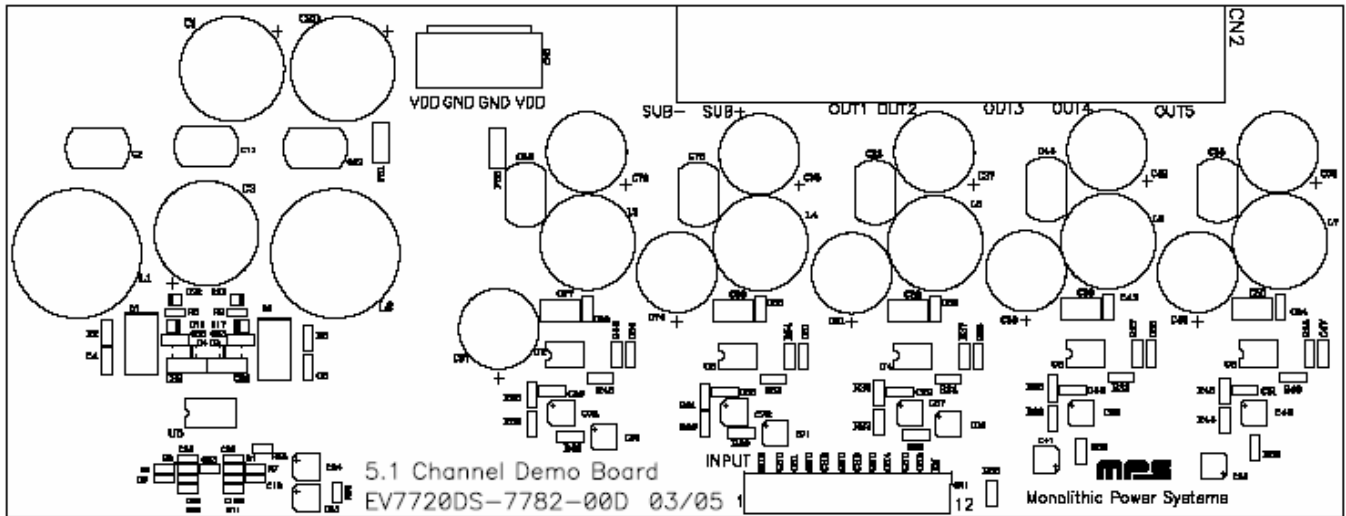

Figure 1—Top Silk Layer

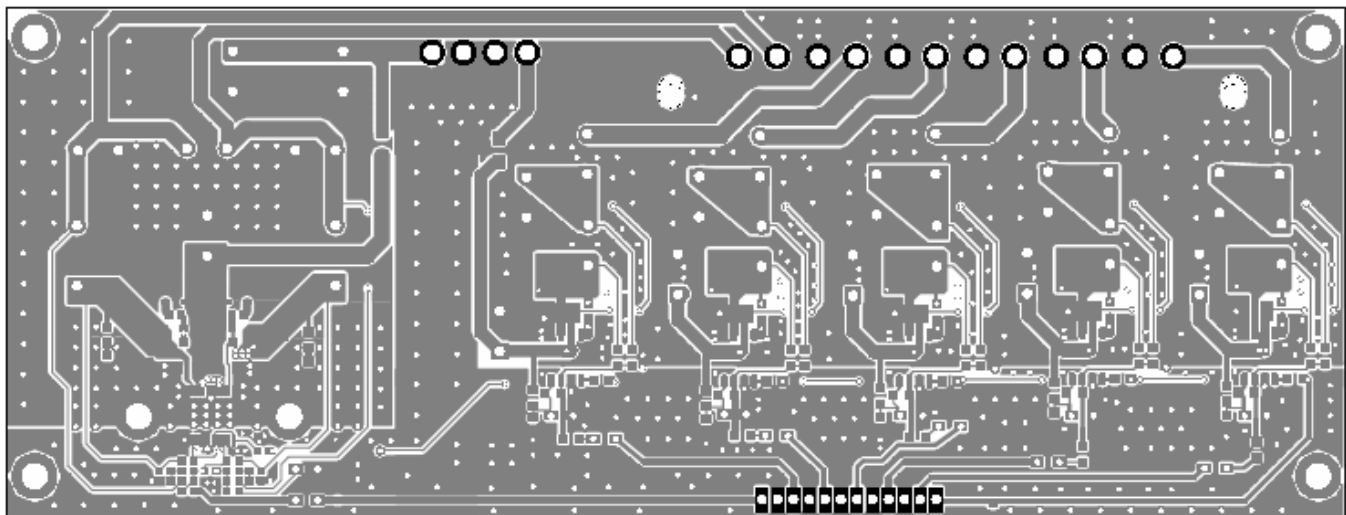

Figure 2—Top Layer

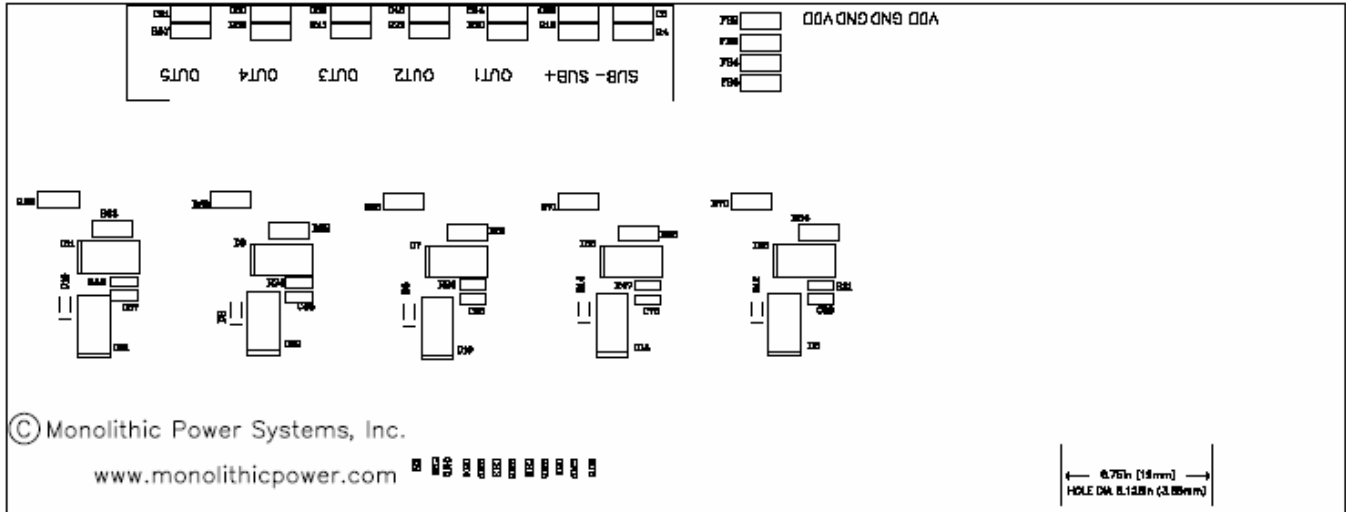

Figure 3—Bottom Silk Layer

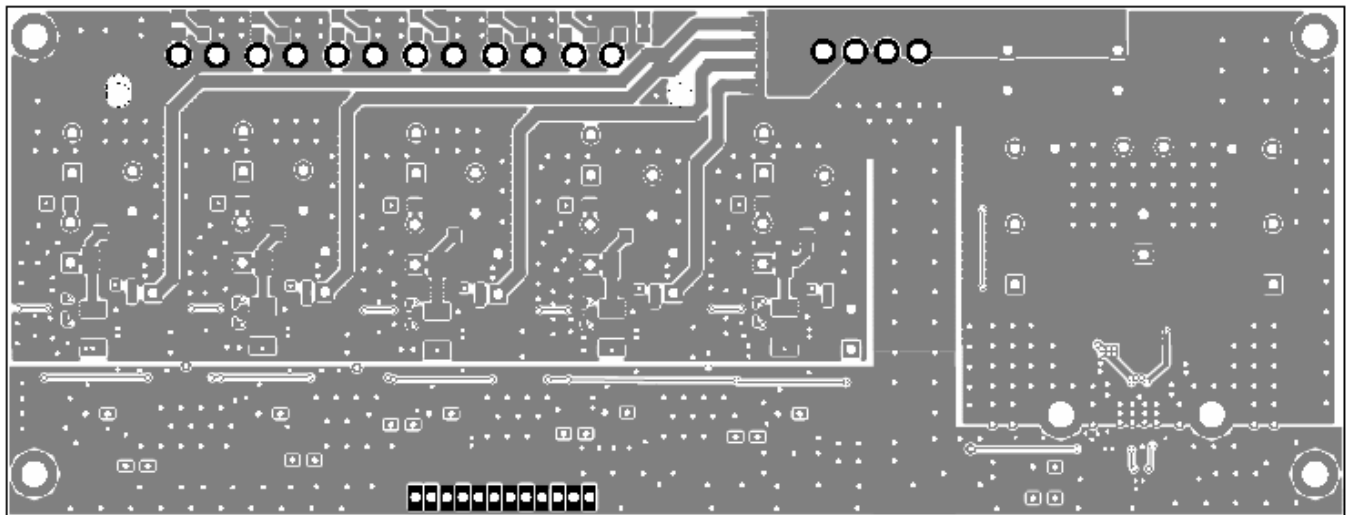
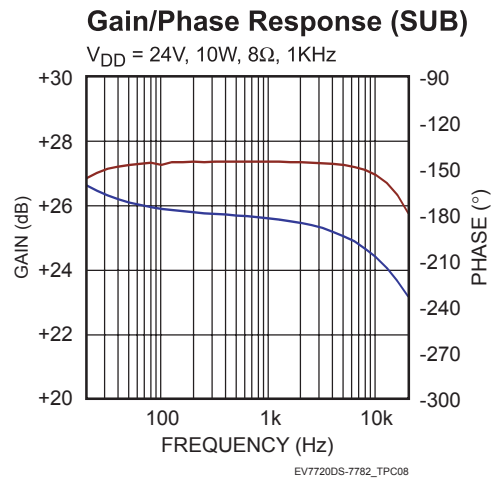
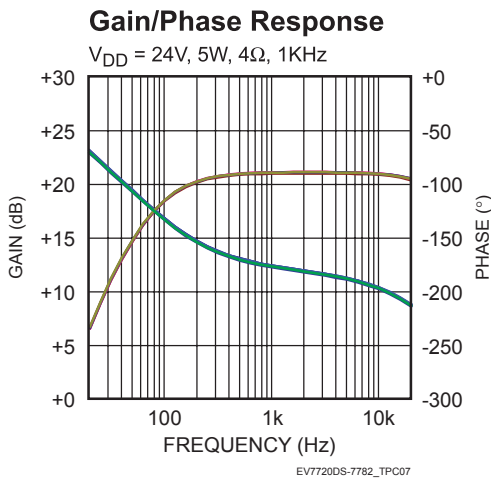
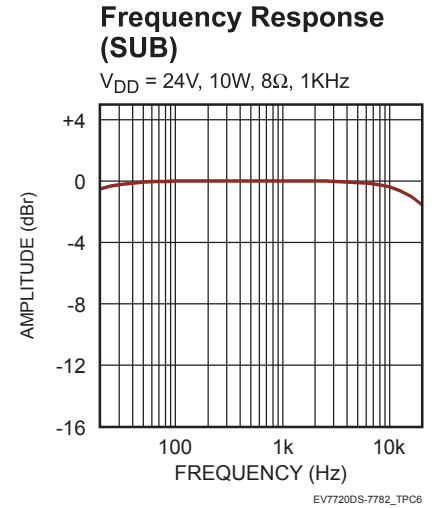
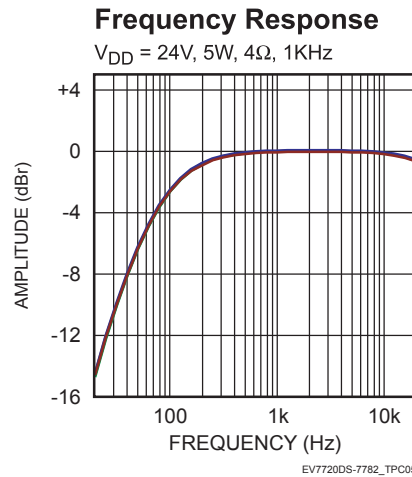
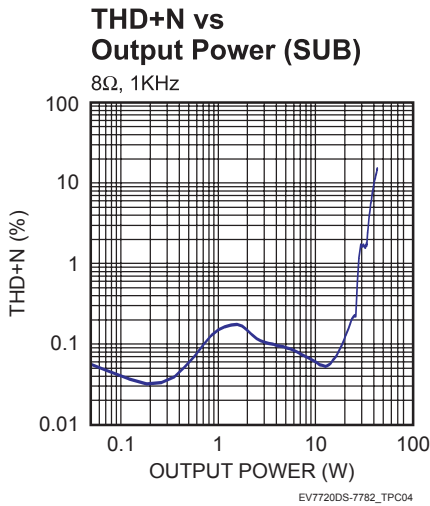
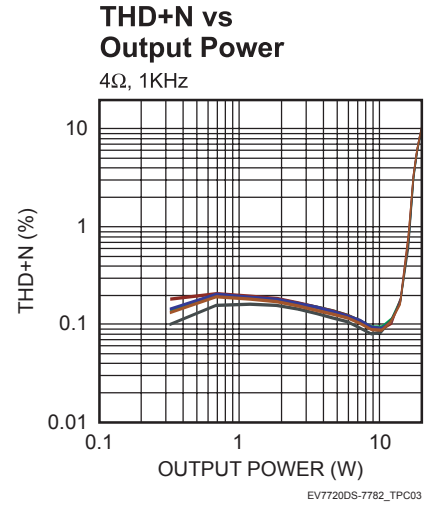
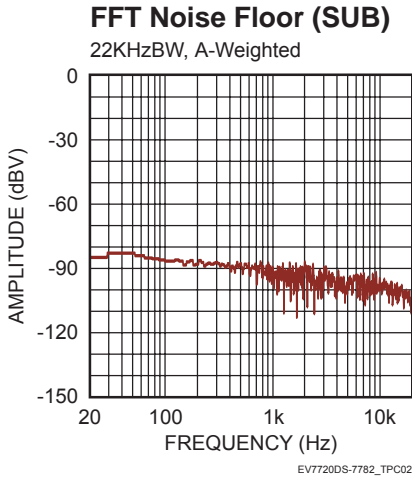
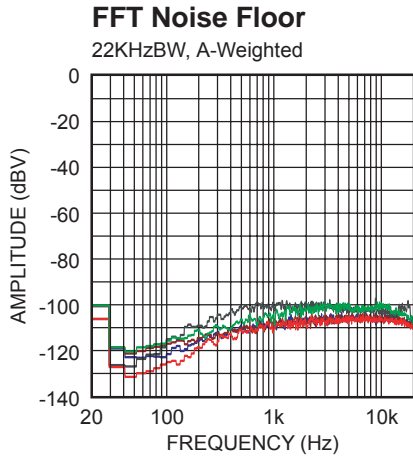

Figure 4—Bottom Layer

TYPICAL PERFORMANCE CHARACTERISTICS



QUICK START GUIDE

1. Input / Output Requirements

- a. Power supply: 9.5V to 24V, 6A
- b. Enable: 3.3V to 5V
- c. 0V to 1V_{RMS} (max) audio signal source, $\leq 600\Omega$.
- d. Main/Satellite Speakers: 4 Ω MINIMUM
- e. Subwoofer: 6 Ω MINIMUM

2. Setup Condition for 24V Operation

- a. Connect the satellite speakers (4 Ω MINIMUM) to the output terminals OUT1 through OUT5 to - normally Left Front, Right Front, Left Rear, Right Rear, and Center.
- b. Connect the subwoofer speaker (6 Ω MINIMUM) to the SUB+ / SUB- output terminals.
- c. Adjust the power supply to $9.5 \leq V_{DD} \leq 24V$ (do not turn on).
- d. Set the enable signal to LOW by applying 0V to the enable input.
- e. With the power supply off, connect the power supply to the V_{DD} terminals.
- f. Connect the audio input signal sources to the amplifier inputs corresponding to output channels.
- g. Turn on the power supply to apply power to the board.

3. Music Turn-On Sequence

- a. UNMUTE the amplifiers by applying 3.3V or 5V to the enable input.
- b. Audio should be heard from the speaker(s).

4. Music Turn-Off Sequence

- a. Set enable LOW by applying 0V to the enable input.

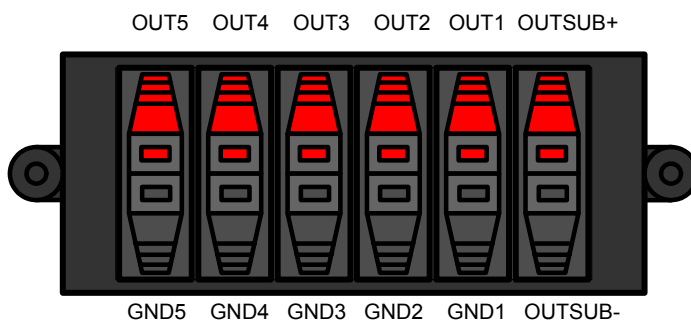

NOTICE: The information in this document is subject to change without notice. Please contact MPS for current specifications. Users should warrant and guarantee that third party Intellectual Property rights are not infringed upon when integrating MPS products into any application. MPS will not assume any legal responsibility for any said applications.