

1.0A SURFACE MOUNT SCHOTTKY BARRIER DIODE

Features

- Schottky Barrier Chip
- Ideally Suited for Automatic Assembly
- Low Power Loss, High Efficiency
- Surge Overload Rating to 30A Peak
- For Use in Low Voltage Application
- Guard Ring Die Construction
- Plastic Case Material has UL Flammability Classification Rating 94V-O

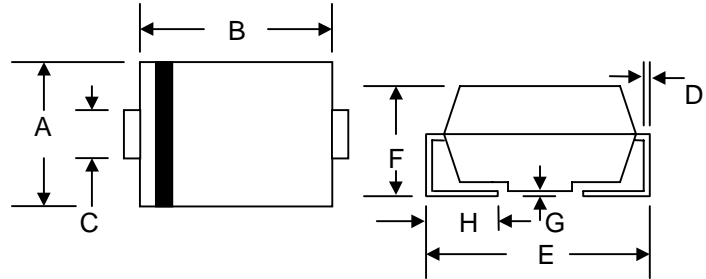

Mechanical Data

- Case: SMA/DO-214AC, Molded Plastic
- Terminals: Solder Plated, Solderable per MIL-STD-750, Method 2026
- Polarity: Cathode Band or Cathode Notch
- Marking: Type Number
- Weight: 0.064 grams (approx.)
- **Lead Free: For RoHS / Lead Free Version, Add "-LF" Suffix to Part Number, See Page 4**

SMA/DO-214AC		
Dim	Min	Max
A	2.50	2.90
B	4.00	4.60
C	1.20	1.60
D	0.152	0.305
E	4.80	5.28
F	2.00	2.44
G	0.051	0.203
H	0.76	1.52
All Dimensions in mm		

Maximum Ratings and Electrical Characteristics @T_A=25°C unless otherwise specified

Characteristic	Symbol	SS12	SS13	SS14	SS15	SS16	SS18	SS19	S100	Unit	
Peak Repetitive Reverse Voltage	V _{RRM}	20	30	40	50	60	80	90	100	V	
Working Peak Reverse Voltage	V _{RWM}										
DC Blocking Voltage	V _R										
RMS Reverse Voltage	V _{R(RMS)}	14	21	28	35	42	56	64	71	V	
Average Rectified Output Current @T _L = 75°C	I _O	1.0								A	
Non-Repetitive Peak Forward Surge Current 8.3ms Single half sine-wave superimposed on rated load (JEDEC Method)	I _{FSM}	30								A	
Forward Voltage @I _F = 1.0A	V _{FM}	0.50		0.70		0.85				V	
Peak Reverse Current @T _A = 25°C	I _{RM}	0.5								mA	
At Rated DC Blocking Voltage @T _A = 100°C		20									
Typical Thermal Resistance (Note 1)	R _{θJL} R _{θJA}	28 88									°C/W
Operating Temperature Range	T _j	-65 to +125								°C	
Storage Temperature Range	T _{STG}	-65 to +150								°C	

Note: 1. Mounted on P.C. Board with 5.0mm² copper pad area.

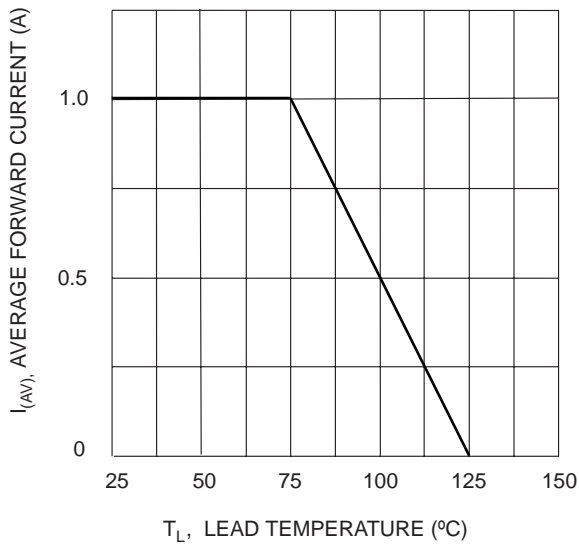

Fig. 1 Forward Current Derating Curve

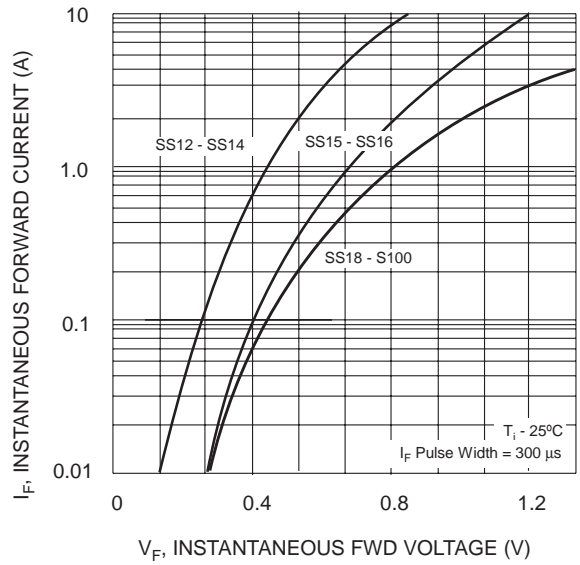

Fig. 2 Typ. Forward Characteristics

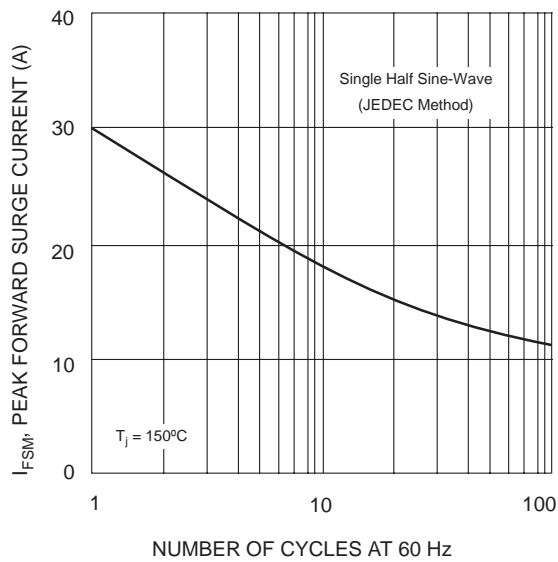

Fig. 3 Max Non-Repetitive Peak Fwd Surge Current

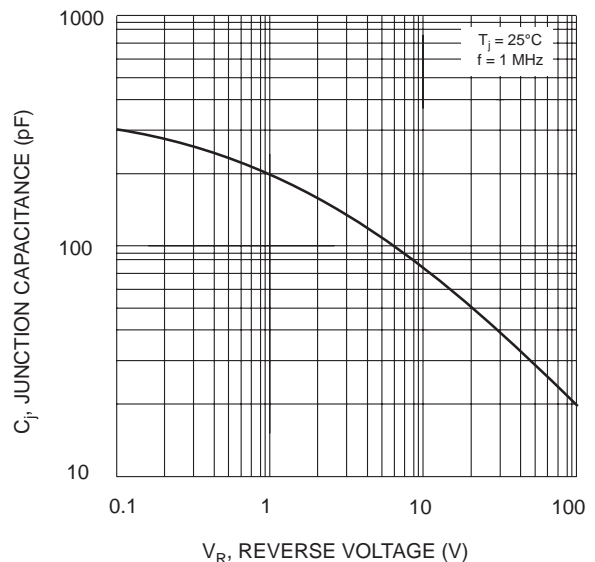

Fig. 4 Typical Junction Capacitance

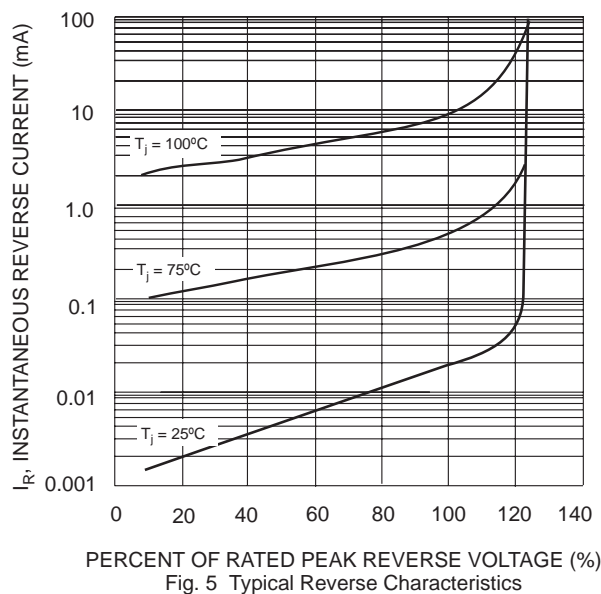

Fig. 5 Typical Reverse Characteristics

MARKING INFORMATION



Cathode = Polarity Band
 WTE = Manufacturer's Logo
 SS1x = Device Number Except S100
 x = 2, 3, 4, 5, 6, 8 or 9

RECOMMENDED FOOTPRINT

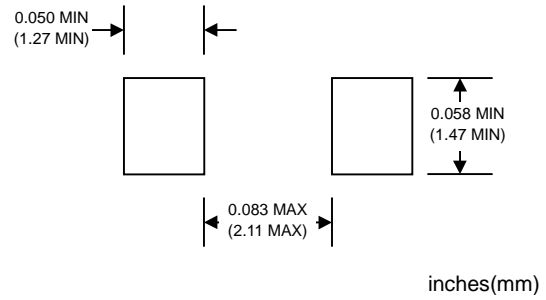

PACKAGING INFORMATION

TAPE & REEL

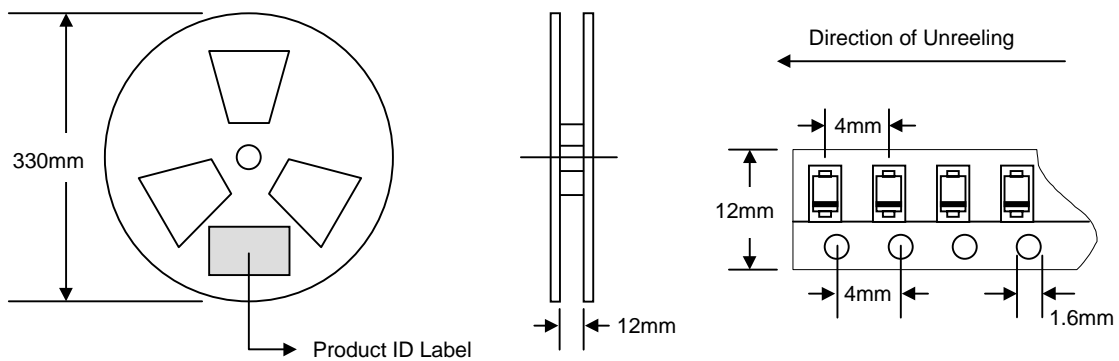

Reel Diameter (mm)	Quantity (PCS)	Inner Box Size L x W x H (mm)	Quantity (PCS)	Carton Size L x W x H (mm)	Quantity (PCS)	Approx. Gross Weight (KG)
330	7,500	340 x 337 x 45	15,000	370 x 370 x 420	120,000	17.5

Note: 1. Paper reel, white or gray color.
 2. Components are packed in accordance with EIA standard 481-1 and 481-2.

ORDERING INFORMATION

Product No.	Package Type	Shipping Quantity
SS12-T3	SMA	7500/Tape & Reel
SS13-T3	SMA	7500/Tape & Reel
SS14-T3	SMA	7500/Tape & Reel
SS15-T3	SMA	7500/Tape & Reel
SS16-T3	SMA	7500/Tape & Reel
SS18-T3	SMA	7500/Tape & Reel
SS19-T3	SMA	7500/Tape & Reel
S100-T3	SMA	7500/Tape & Reel

1. Shipping quantity given is for minimum packing quantity only. For minimum order quantity, please consult the Sales Department.
2. **To order RoHS / Lead Free version (with Lead Free finish), add "-LF" suffix to part number above. For example, SS12-T3-LF.**

Won-Top Electronics Co., Ltd (WTE) has checked all information carefully and believes it to be correct and accurate. However, WTE cannot assume any responsibility for inaccuracies. Furthermore, this information does not give the purchaser of semiconductor devices any license under patent rights to manufacturer. WTE reserves the right to change any or all information herein without further notice.

WARNING: DO NOT USE IN LIFE SUPPORT EQUIPMENT. WTE power semiconductor products are not authorized for use as critical components in life support devices or systems without the express written approval.

Won-Top Electronics Co., Ltd.

No. 44 Yu Kang North 3rd Road, Chine Chen Dist., Kaohsiung, Taiwan

Phone: 886-7-822-5408 or 886-7-822-5410

Fax: 886-7-822-5417

Email: sales@wontop.com

Internet: <http://www.wontop.com>

We power your everyday.