



general description

The MM5322 Color Bar Generator Chip is a complete dot-bar and color hue generation system in a single monolithic P-channel MOS integrated circuit. The chip divides an internal oscillator (crystal controlled) frequency to provide the various timing, synchronization, and video information required in the alignment of color television receivers. A composite video output is provided for complete black and white dot-bar operation. It consists of all synchronization, blanking, and video information required for a fairly standard set of dot, bar, and cross hatch screen patterns. In addition a separate output for precise gating of 3.56 MHz color bursts is provided. For servicing ease an oscilloscope trigger is provided on either the horizontal blanking or vertical synchronization time slots.

features

- Battery operation
- Oscilloscope trigger
- Composite video output signal
- Crystal controlled oscillator
- Multiple screen patterns
- Variable dot size

applications

- Battery or bench powered test instruments
- Manufacturing test sets
- Built in test capability

typical application

Typical Color Bar Generator Circuit

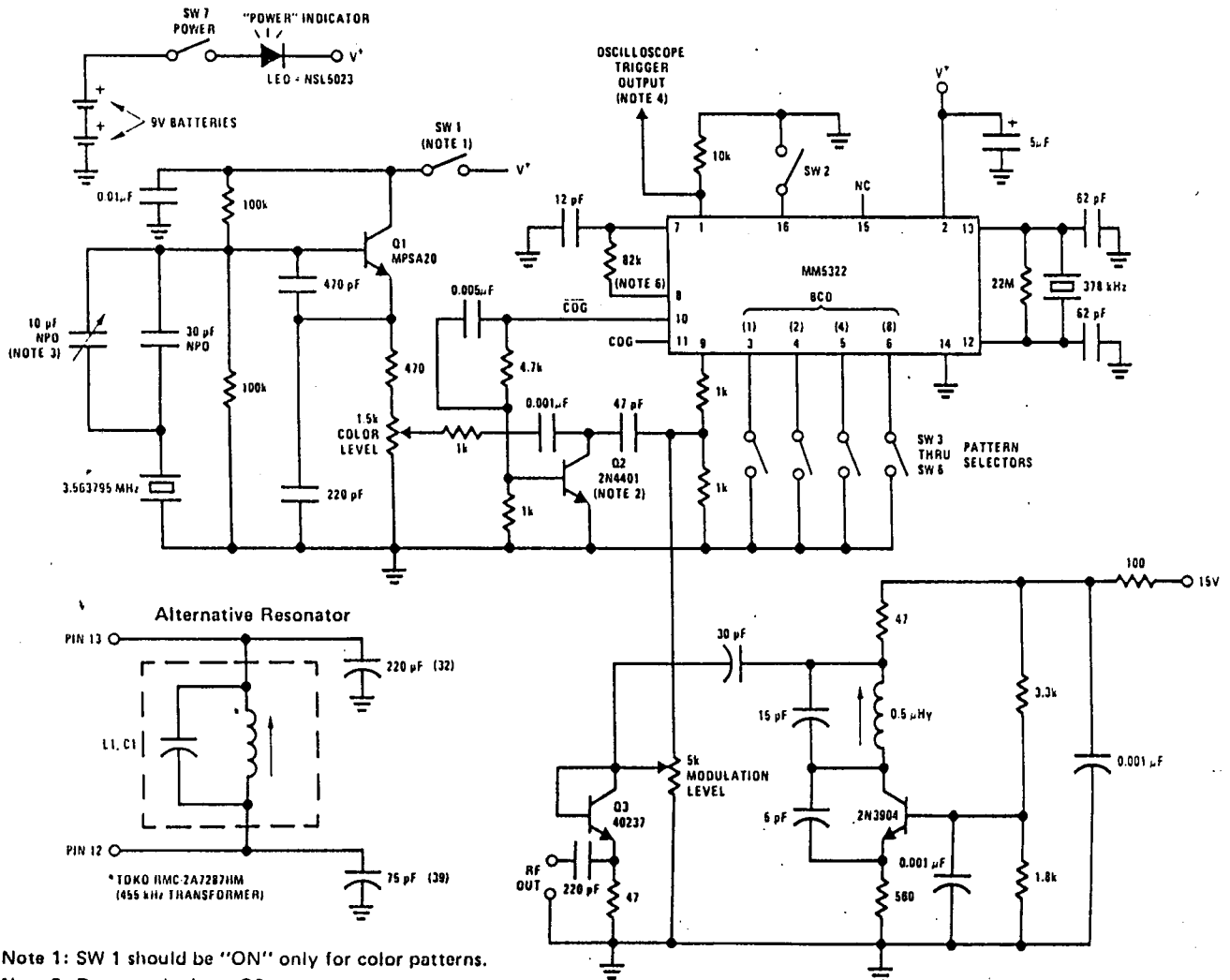

Note 1: SW 1 should be "ON" only for color patterns.

Note 2: Do not substitute Q2.

Note 3: Variable cap may be used to trim color crystal to exact frequency.

Note 4: SW 2 and 10k resistor on pins 16 and 1 are needed only if scope trigger pulse is desired.

Note 5: SW 2 selects "H" or "V" trigger output pulses.

Note 6: A 27k resistor in series with a 100k trimpot may be used in place of 82k resistor for variable vertical line width.

Note 7: Modulation level adjusted for best patterns as viewed on TV screen.

# absolute maximum ratings

Voltage at Any Pin	$V_{SS}+0.3V$ to $V_{SS}-25V$
Operating Temperatures	$-25^{\circ}C$ to $+75^{\circ}C$
Storage Temperature	$-65^{\circ}C$ to $+150^{\circ}C$
Lead Temperatures (Soldering, 10 seconds)	$300^{\circ}C$

## electrical characteristics $T_A$ within operating range, $V_{SS} = +12$ to $+19V$ , $V_{GG} = 0V$

PARAMETER	CONDITIONS	MIN	TYP	MAX	UNITS
Power Supply Voltage ( $V_{SS}$ )		12		19	V
Clock Input Frequency OSC 1 and 2	Crystal or External Drive (Note 1)		378		kHz
Clock Input Levels	For External Drive (Note 1)				
Logical High		$V_{SS}-2$		$V_{SS}+0.3$	V
Logical Low		$V_{GG}$		$V_{GG}+2$	V
Control Inputs BCD and Trigger	Internal Resistor To $V_{SS}$ , 1M $\Omega$ Min. (Note 2)				
Logical High		$V_{SS}-2$		$V_{SS}+0.3$	V
Logical Low		$V_{GG}$		$V_{GG}+2$	V
Control Output Currents Cog and $\overline{Cog}$					
Logical High	$V_{SS} - 2.0V$	2.5			mA
Logical Low	$V_{GG} - V_{GG}/2$ (Note 3)	0.25			mA
Trigger and Z					
Logical High	With 10k to $V_{GG}$ , $V_{GG} + 5.0V$ (Note 4)	0.5			mA
Logical High	With 1k to $V_{GG}$ , $V_{GG} + 1$ (Note 4)	1.0			mA
Video Output					
Analog Highs	With 2k to $V_{GG}$ (Note 5)		2.0 to 4.0		mA
Power Supply Current	$T_A = 25^{\circ}C$ , Freq = 378 kHz, $V_{GG} = 0V$ , $V_{SS} = +19V$			30	mA

Note 1: The oscillator may be operated with external components to oscillate at 378 kHz or it may be driven by an external pulse source using OSC 2 (Pin 13) as an input.

Note 2: These inputs are driven by switches.

Note 3: The color gate outputs are push-pull buffers.

Note 4: The trigger output and Z output are open drain outputs and require a resistor to  $V_{GG}$  for operation. Two possible resistor values are shown with their associated voltage and current levels.

Note 5: The video output requires a resistor to  $V_{GG}$  for operation. This resistor must be trimmed externally to achieve the desired output levels. The minimum voltage swing is 4.0 volts with a 10% change with temperature and from unit to unit. The percentage magnitude change with supply voltage can approach one.

## composite video output

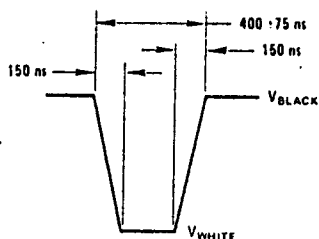

FIGURE 1. White Dot Video Information Pulse Width

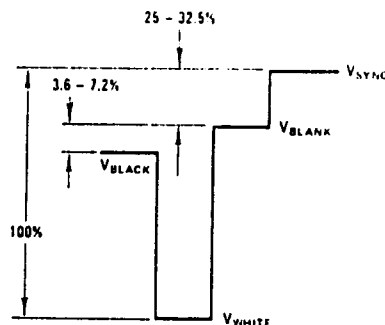
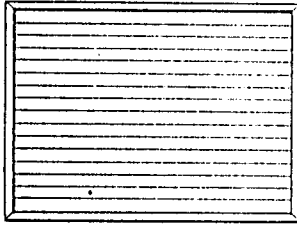
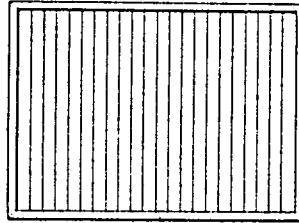

FIGURE 2. Composite Video Voltage Percentages

# video output patterns



15 Horizontal Lines  
0000



21 Vertical Lines  
0001

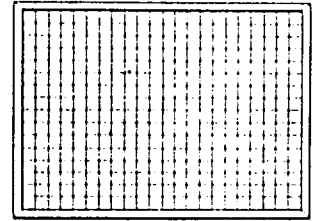

15 x 21 Cross Hatch  
0010



Gated Rainbow  
0011

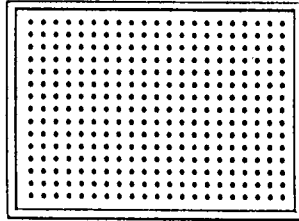

Dots 15 x 21  
0100



Note: Pattern switch codes are BCD 1248 positive logic

Purity  
0101

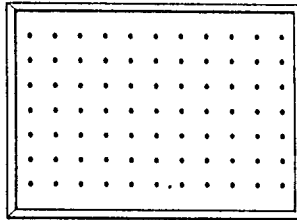

Dots 7 x 11  
0110

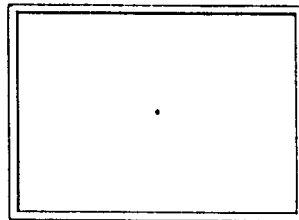

Single Dot  
0111



Gated Rainbow  
1000

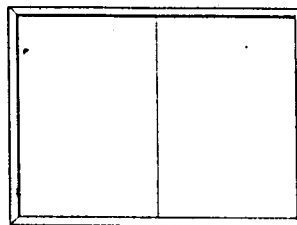

Single Vertical Line  
1001

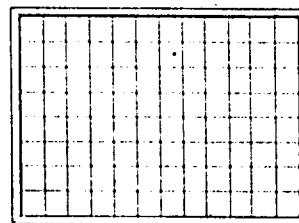

7 x 11 Cross Hatch  
1010

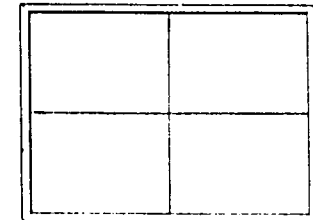

Single Crosshair  
1011

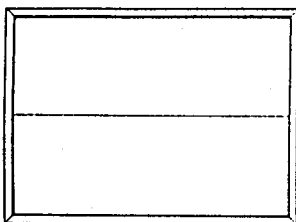

Single Horizontal Line  
1100

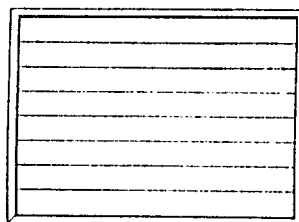

7 Horizontal Lines  
1101

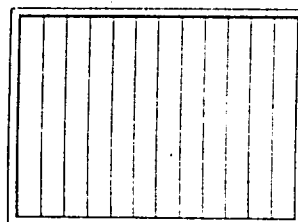

11 Vertical Lines  
1110

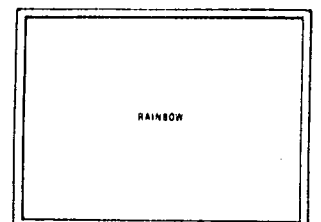

Ungated Rainbow  
1111

composite video output (con't)

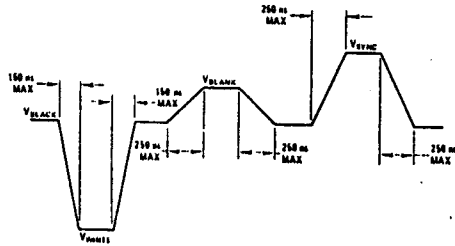

FIGURE 3. Composite Video Rise and Fall Times

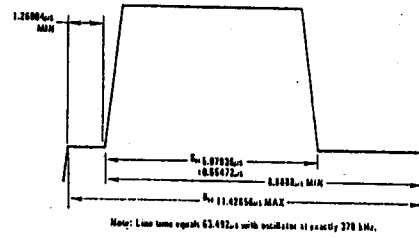
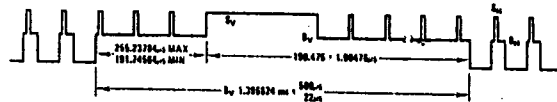

FIGURE 4. Composite Video Pulse Timing, Horizontal Sync



Note: Frame frequency equals 60.14645 Hz.

FIGURE 5. Composite Video Pulse Timing, Vertical Sync

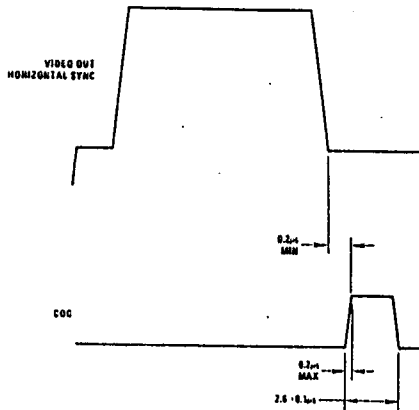

FIGURE 6. Color Gate Signal Timing

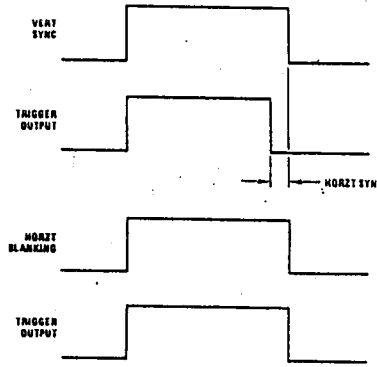
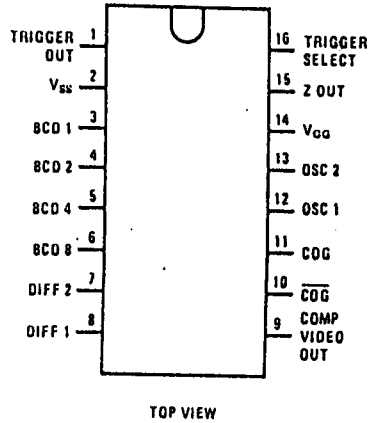

FIGURE 7. Trigger Output Timing Relationship

Dual-In-Line Package



Note: ZOUT is an internal counter test point.

0.5000 ✓ G



ncm corporation

1500 Wyatt Drive, Santa Clara, CA 95054 • (408) 496-0290 • Telex 172932 • Fax (408) 496-0388

Specifications subject to change.  
© 1987 NCM Corporation.  
Printed in U.S.A.