

SIEMENS AKTIENGESELLSCHAFT

Main ratings

Drain-source voltage $V_{DS} = 500\text{ V}$
 Continuous drain current $I_D = 4,4\text{ A}$
 Drain-source on-resistance $R_{DS(on)} = 2\ \Omega$

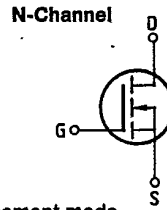

Description FREDFET with fast-recovery reverse diode, N-channel, enhancement mode.
Case Plastic package 14 A 3 in accordance with DIN 41869, or TO 220 AB in accordance with JEDEC. The drain terminal is conductively connected to the mounting flange. Approx. weight 2 g

Type	Ordering code
BUZ 216	C67078-A1402-A2

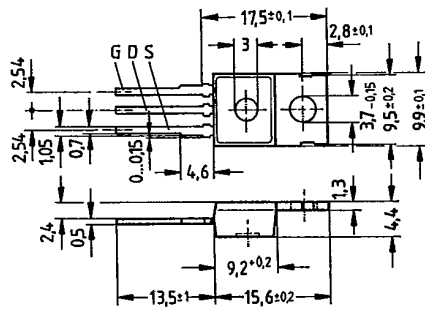

Dimensions in mm

Maximum ratings

Description	Symbols	Ratings	Units	Conditions
Drain-source voltage	V_{DS}	500	V	
Drain-gate voltage	V_{DGR}	500	V	$R_{GS} = 20\text{ k}\Omega$
Continuous drain current	I_D	4,4	A	$T_C = 25\text{ }^\circ\text{C}$
Pulsed drain current	$I_{D(puls)}$	17	A	$T_C = 25\text{ }^\circ\text{C}$
Gate-source voltage	V_{GS}	± 20	V	
Max. power dissipation	P_D	75	W	$T_C = 25\text{ }^\circ\text{C}$
Operating and storage temperature range	T_j T_{stg}	$-55 \dots +150$	$^\circ\text{C}$	
DIN humidity category		E	-	DIN 40040
IEC climatic category		55/150/56	-	DIN IEC 68-1

Thermal resistance

Chip - case	R_{thJC}	$\leq 1,67$	K/W
Chip - ambient	R_{thJA}	≤ 75	K/W

Electrical characteristics(at $T_j = 25^\circ\text{C}$ unless otherwise specified)

Description	Symbol	Characteristics			Unit	Conditions
		min.	typ.	max.		
Static ratings						
Drain-source breakdown voltage	$V_{(BR)DSS}$	500	—	—	V	$V_{GS} = 0V$ $I_D = 0,25mA$
Gate threshold voltage	$V_{GS(th)}$	2,1	3,0	4,0		$V_{DS} = V_{GS}$ $I_D = 1mA$
Zero gate voltage drain current	I_{DSS}	—	20	250	μA	$T_j = 25^\circ\text{C}$ $T_j = 125^\circ\text{C}$ $V_{DS} = 500V$ $V_{GS} = 0V$
Gate-source leakage current	I_{GSS}	—	10	100	nA	$V_{GS} = 20V$ $V_{DS} = 0V$
Drain-source on-resistance	$R_{DS(on)}$	—	1,7	2,0	Ω	$V_{GS} = 10V$ $I_D = 3,2A$
Dynamic ratings						
Forward transconductance	g_{fs}	1,5	2,7	—	S	$V_{DS} = 25V$ $I_D = 3,2A$
Input capacitance	C_{iss}	—	1,5	2,0	nF	$V_{GS} = 0V$ $V_{DS} = 25V$ $f = 1MHz$
Output capacitance	C_{oss}	—	110	170	pF	
Reverse transfer capacitance	C_{rss}	—	40	70		
Turn-on time t_{on} ($t_{on} = t_{d(on)} + t_r$)	$t_{d(on)}$	—	30	45	ns	$V_{CC} = 30V$ $I_D = 2,5A$ $V_{GS} = 10V$ $R_{GS} = 50\Omega$
	t_r	—	40	60		
Turn-off time t_{off} ($t_{off} = t_{d(off)} + t_f$)	$t_{d(off)}$	—	110	140		
	t_f	—	50	65		
Fast-recovery reverse diode						
Continuous reverse drain current	I_{DR}	—	—	4,4	A	$T_C = 25^\circ\text{C}$
Pulsed reverse drain current	I_{DRM}	—	—	17		
Diode forward on-voltage	V_{SD}	—	1,3	1,6	V	$I_F = 2 \times I_{DR}$ $V_{GS} = 0V, T_j = 25^\circ\text{C}$
Reverse recovery time	t_{rr}	—	180	250	ns	$T_j = 25^\circ\text{C}$ $T_j = 150^\circ\text{C}$ $I_F = I_{DR}$ $di/dt = 100A/\mu s$ $V_R = 100V$
Reverse recovery charge	Q_{rr}	—	0,65	1,2		
Repetitive peak reverse current	I_{RRM}	—	—	—	A	$T_j = 25^\circ\text{C}$ $T_j = 150^\circ\text{C}$
		—	15	—		

Power dissipation $P_D = f(T_C)$

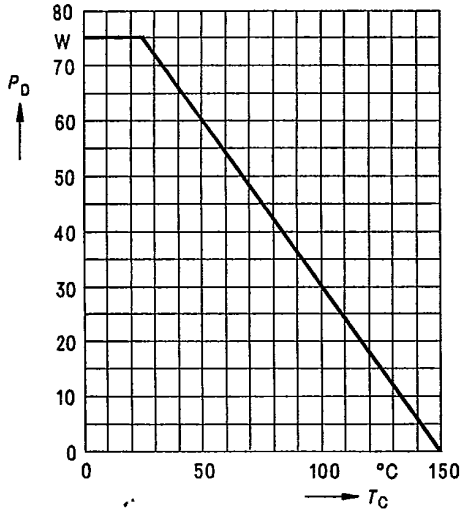

Typical output characteristics $I_D = f(V_{DS})$
parameter: 80 μ s pulse test,
 $T_j = 25^\circ\text{C}$

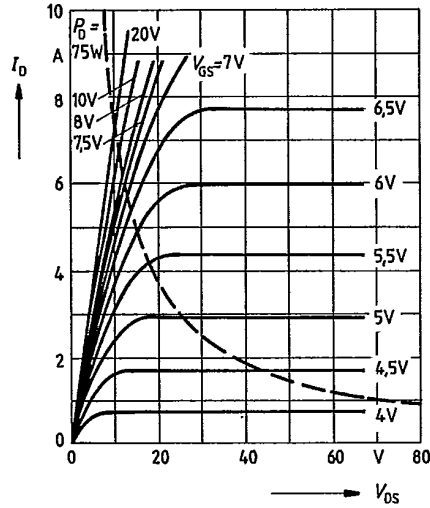

Safe operating area $I_D = f(V_{DS})$
parameter: $D = 0.01$, $T_C = 25^\circ\text{C}$

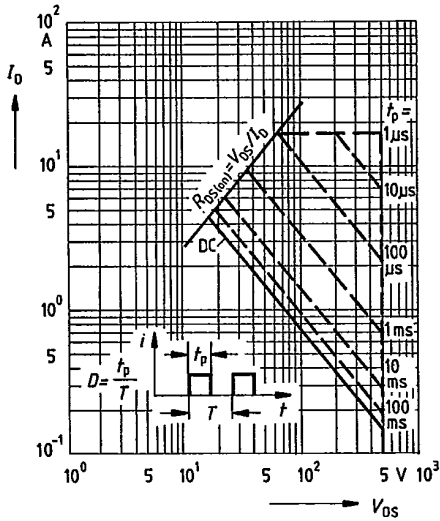

Typical transfer characteristic $I_D = f(V_{GS})$
parameter: 80 μ s pulse test,
 $V_{DS} = 25\text{V}$, $T_j = 25^\circ\text{C}$

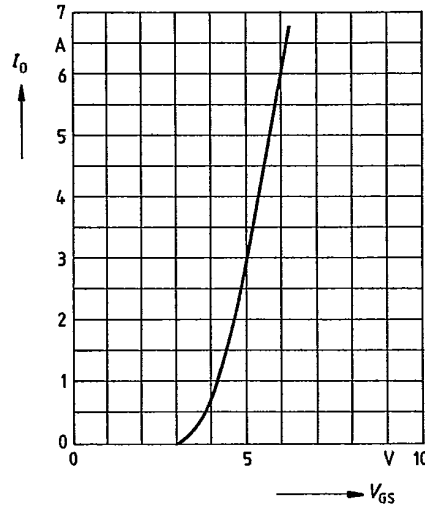

SIEMENS AKTIENGESELLSCHAFT

Typical drain-source on-state resistance

$R_{DS(on)} = f(I_D)$
parameter: $V_{GS} = 10V$, $T_j = 25^\circ C$

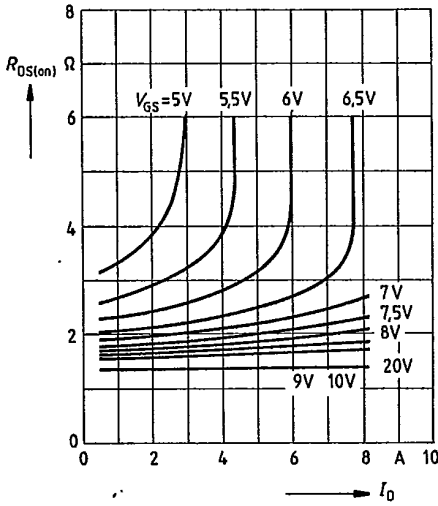

Drain-source on-state resistance

$R_{DS(on)} = f(T_j)$
parameter: $I_D = 3.2A$, $V_{GS} = 10V$
(spread)

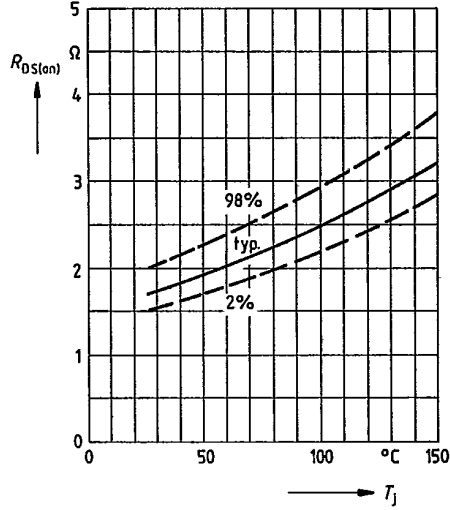

Typical transconductance $g_{fs} = f(I_D)$

parameter: 80 μs pulse test,
 $V_{DS} = 25V$, $T_j = 25^\circ C$

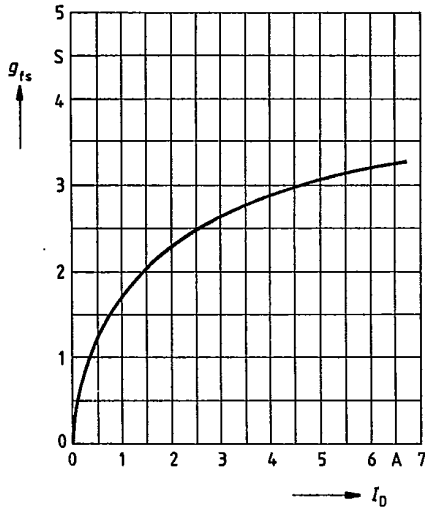

Gate threshold voltage $V_{GS(th)} = f(T_j)$

parameter: $V_{DS} = V_{GS}$, $I_D = 1mA$
(spread)

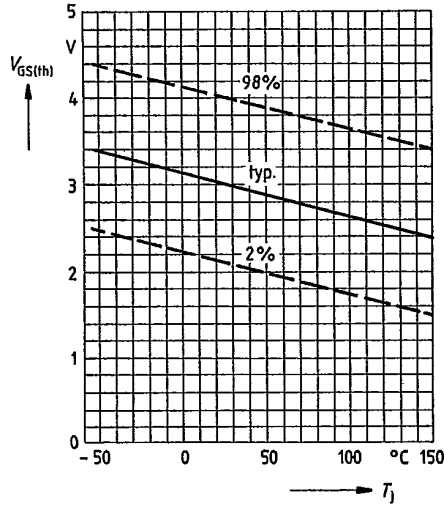

Typical capacitances $C = f(V_{GS})$
parameter: $V_{GS} = 0, f = 1\text{MHz}$

Continuous drain current $I_D = f(T_C)$
parameter: $V_{GS} \geq 10\text{V}$

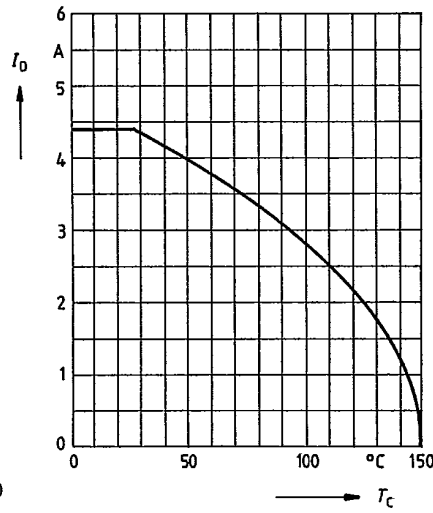
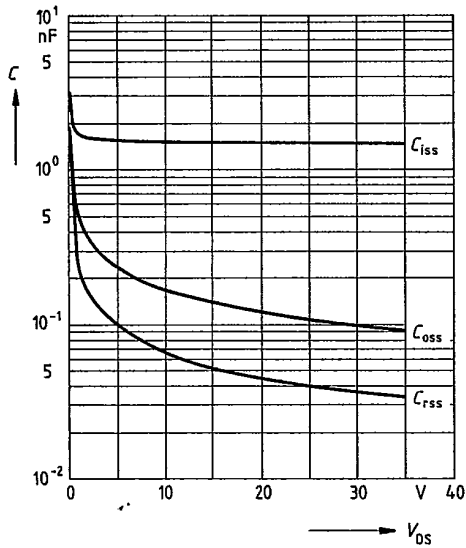

Forward characteristic of reverse diode

$I_F = f(V_{SD})$
parameter: $T_j, t_p = 80 \mu\text{s}$
(spread)

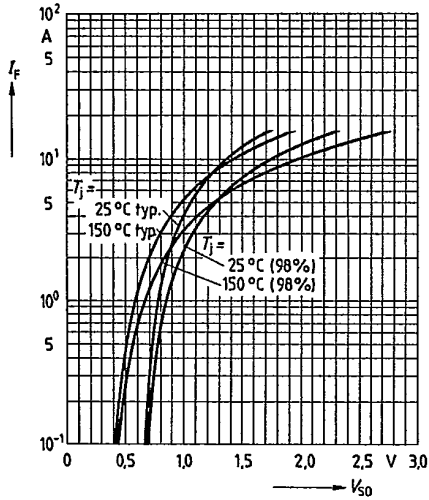

— SIEMENS AKTIENGESELLSCHAFT —

Transient thermal impedance $Z_{thJC} = f(t)$
 parameter: $D = t_p/T$

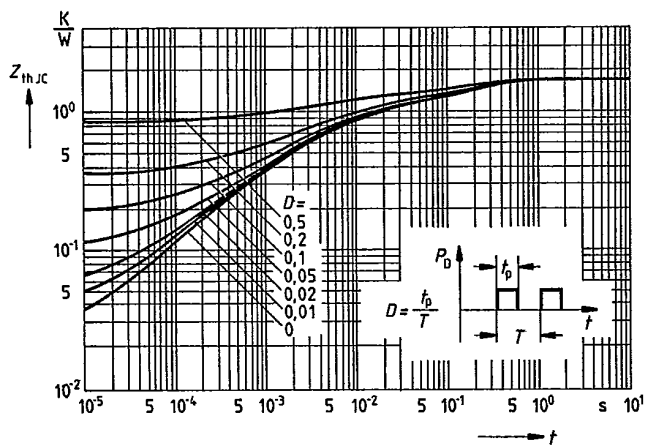

Typical gate-charge $V_{GS} = f(Q_{Gate})$
 parameter: $I_{D\ puls} = 6.8A$

