

## MT1110 75Ω BROADBAND AMPLIFIER ADVANCE DATA SHEET

## CATV DISTRIBUTION APPLICATIONS

### 1 APPLICATIONS

- Set-top box
- Home gateways
- CATV Broadband distribution
- Cable splitters
- Laser drivers
- Optical receivers

### 2 FEATURES

- Cascadable 75Ω gain block
- 15 dB Gain
- 3 dB Noise figure
- Unconditionally stable
- 20 dB Input return loss
- 1 MHz to 2000 MHz 3 dB bandwidth
- +0.5 dB Gain tilt from 50 MHz to 850 MHz
- Typical OIP3 at 70 mA is 80 dBmV at 850 MHz
- Single +5V supply
- 70 mA Current consumption
- SOT-89 Package
- Industry standard pin-out for drop in compatibility

### 3 OVERVIEW

The Microtune 1110 (MT1110) broadband amplifier is a 75Ω internally matched amplifier designed for broadband CATV distribution and infrastructure applications. The MT1110 is built using high performance silicon-germanium (SiGe) technology and offers 15 dB gain with an industry best noise figure of 3.0 dB. It achieves a third order intercept point of 80 dBmV while drawing the industry's lowest current, 70 mA, from a single 5V supply.

Specifically designed for cable, data, and video applications, the MT1110 features a unique integrated equalization circuit that adds 0.5 dB of positive tilt to the gain slope to compensate for a commonly occurring frequency dependent attenuation found in broadband applications.

The MT1110's Darlington circuit topology produces high linearity with very low noise while maintaining matched input and output impedances. Two AC coupling capacitors, a bias resistor, and an optional inductor are the only external components required.

The MT1110 is available in a SOT-89 package for the extended industrial temperature range of -40°C to +85°C.

Preliminary



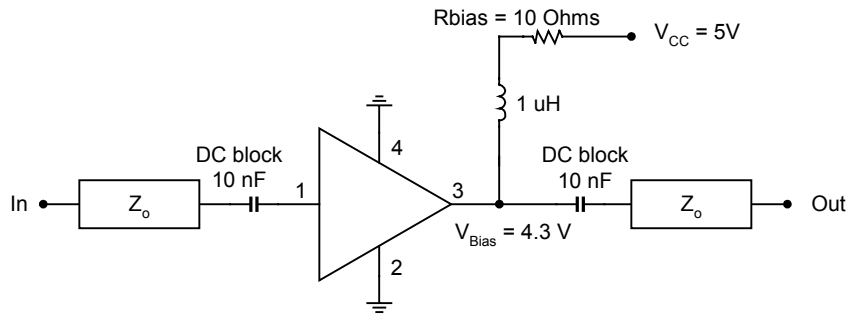

Figure 1 Typical Application

#### 4 ABSOLUTE MAXIMUM RATINGS

Stresses greater than those listed in Table 1 may cause permanent damage to the device. These are stress ratings only; functional operation of the device under conditions other than those listed in the operational sections of this document is not recommended or implied. Exposure to any of the absolute maximum rating conditions for extended periods of time may affect reliability.

Table 1 Absolute Maximum Stress Ratings

| PARAMETER                                | MIN  | MAX  | UNIT |
|--|------|------|------|
| Device voltage                           | -0.7 | 5    | V    |
| Device current                           |      | 100  | mA   |
| RF Input power                           |      | 60   | dBmV |
| Junction temperature                     |      | +125 | °C   |
| Storage temperature range                | -55  | +150 | °C   |
| Lead temperature (soldering, 10 seconds) |      | +245 | °C   |

#### 5 DC ELECTRICAL CHARACTERISTICS

Table 2 Recommended Bias Resistor Values

| SUPPLY VOLTAGE      | 5V | 6V | 9V | 12V | UNIT |
|---------------------|----|----|----|-----|------|
| $R_{Bias}$ at 70 mA | 10 | 24 | 67 | 110 | Ω    |

Preliminary



## 6 AC ELECTRICAL CHARACTERISTICS

The AC electrical characteristics listed in Table 3 are valid for the following conditions unless otherwise noted. Typical parameters are at  $T_A = +25^\circ\text{C}$ .

- Device current = 70 mA
- $V_{\text{Bias}} = 4.3 \text{ V}$
- $Z_0 = 75\Omega$
- $T_A = -40^\circ\text{C}$  to  $+85^\circ\text{C}$

**Table 3 AC Electrical Characteristics**

| PARAMETER                           | SYMBOL | CONDITIONS   | MIN  | TYP | MAX  | UNIT |
|-------------------------------------|--------|--|------|-----|------|------|
| Power gain                          | S21    | 45 MHz to 870 MHz  |      | 15  |      | dB   |
| 3 dB Gain bandwidth                 |        | Lower frequency determined by external components              | 1    |     | 2000 | MHz  |
| Noise figure                        | NF     | 45 MHz to 870 MHz  |      | 3   | 3.5  | dB   |
| Composite triple beat               | CTB    | 79 Channels, output = 25 dBmV per tone                         |      | -72 |      | dBc  |
|                                     |        | 112 Channels, output = 25 dBmV per tone                        |      | -71 |      | dBc  |
|                                     |        | 132 Channels, output = 25 dBmV per tone                        |      | -70 |      | dBc  |
| Composite second order (sum)        | CSO    | 79 Channels, output = 25 dBmV per tone                         |      | -61 |      | dBc  |
|                                     |        | 112 Channels, output = 25 dBmV per tone                        |      | -58 |      | dBc  |
|                                     |        | 132 Channels, output = 25 dBmV per tone                        |      | -53 |      | dBc  |
| Composite second order (difference) | CSO    | 79 Channels, output = 25 dBmV per tone                         |      | -54 |      | dBc  |
|                                     |        | 112 Channels, output = 25 dBmV per tone                        |      | -53 |      | dBc  |
|                                     |        | 132 Channels, output = 25 dBmV per tone                        |      | -52 |      | dBc  |
| Cross modulation                    | Xmod   | 79 Channels, output = 25 dBmV per tone                         |      | -68 |      | dBc  |
|                                     |        | 112 Channels, output = 25 dBmV per tone                        |      | -65 |      | dBc  |
|                                     |        | 132 Channels, output = 25 dBmV per tone                        |      | -63 |      | dBc  |
| Third order intercept point         | OIP3   | F1 = 54.25 MHz, F2 = 60.25 MHz,<br>Output = 55 dBmV per tone   |      | 83  |      | dBmV |
|                                     |        | F1 = 403.25 MHz, F2 = 409.25 MHz,<br>Output = 55 dBmV per tone |      | 82  |      | dBmV |
|                                     |        | F1 = 853.25 MHz, F2 = 859.25 MHz,<br>Output = 55 dBmV per tone |      | 80  |      | dBmV |
| Second order intercept point        | OIP2   | F = 403.25 MHz<br>F = 409.25 MHz                               |      | 105 |      | dBmV |
| Output power 1 dB compression point | P1dB   | F = 859.25 MHz   |      | 66  |      | dBmV |
| Slope straight line                 | SL     | 45 MHz to 870 MHz  |      | 0.5 |      | dB   |
| Flatness straight line              | FL     | 45 MHz to 870 MHz  | -0.5 |     | 0.5  | dB   |
| Flatness narrow band                | FLnb   | In each 6 MHz segment  |      |     | ±0.2 | dB   |
| Reverse isolation                   | S12    | 50 MHz to 850 MHz  |      | 18  |      | dB   |
| Input Return Loss                   | S11    |  | 18   | 20  |      | dB   |
| Output Return Loss                  | S22    |  | 10   | 16  |      | dB   |

Preliminary



## 7 TYPICAL PERFORMANCE

The following data is representative of a part measured in a typical application circuit.

- Device Current = 70 mA
- $V_{Bias} = 4.3\text{ V}$
- $Z_0 = 75\Omega$
- $T_A = 25^\circ\text{C}$

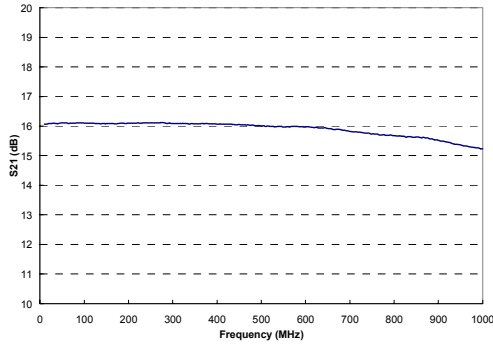

Figure 2 Power Gain vs Frequency

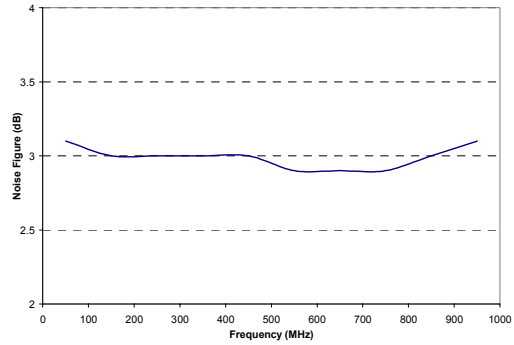

Figure 3 Noise Figure vs Frequency

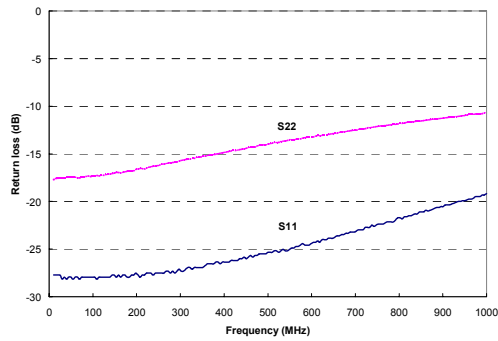

Figure 4 Return Loss vs Frequency

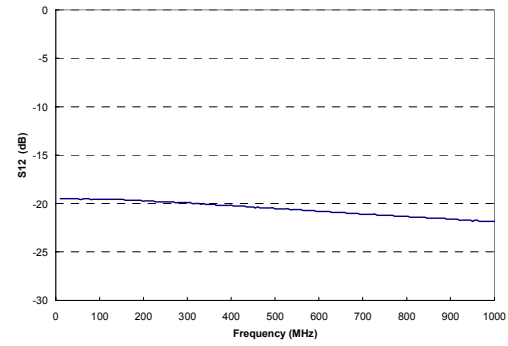

Figure 5 Reverse Isolation vs Frequency

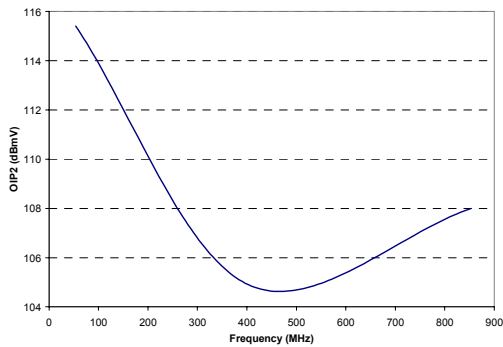

Figure 6 OIP2 vs Frequency

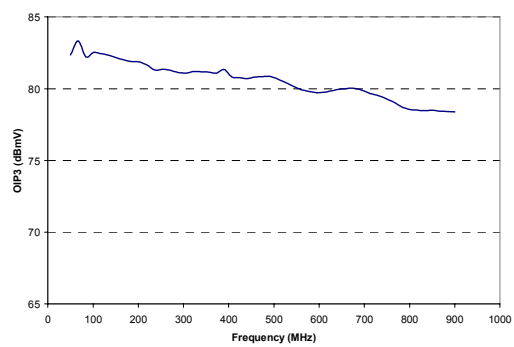

Figure 7 OIP3 vs Frequency

Preliminary



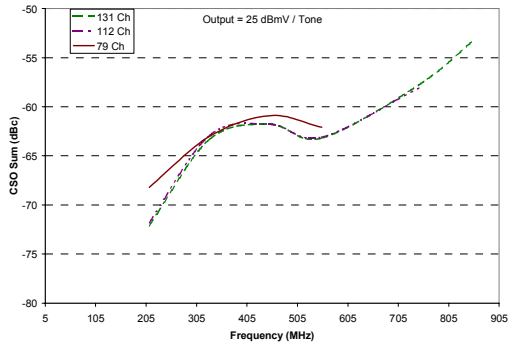

Figure 8 CSO Sum vs Frequency

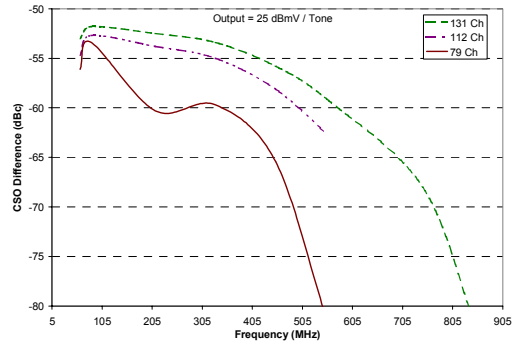

Figure 9 CSO Difference vs Frequency

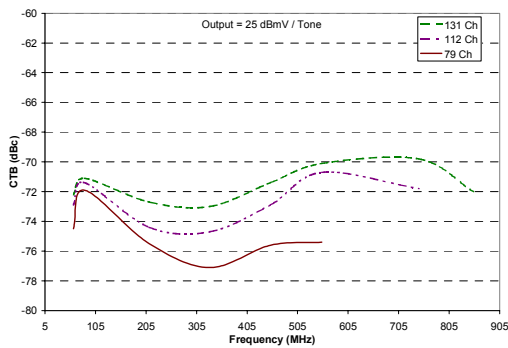

Figure 10 CTB vs Frequency

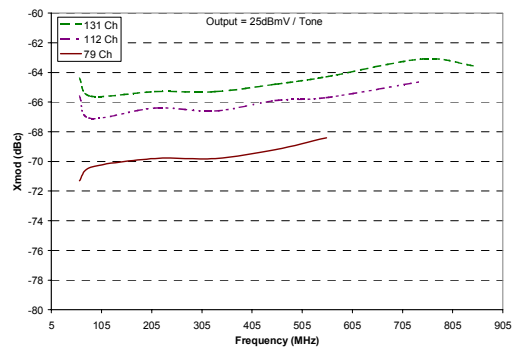

Figure 11 Xmod vs Frequency

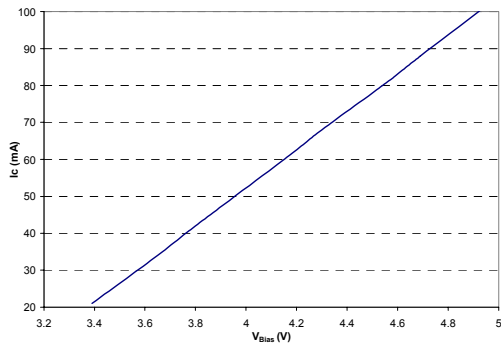

Figure 12 Collector Current vs  $V_{Bias}$

Preliminary



## 8 TYPICAL S-PARAMETERS

Table 4 Typical S-Parameters ( $V_{Bias} = 4.3V$ ,  $I_{cc} = 70\text{ mA}$ )

| FREQ. MHz | S11   | S11 ANG  | S21   | S21 ANG | S12   | S12 ANG | S22   | S22 ANG  |
|-----------|-------|----------|-------|---------|-------|---------|-------|----------|
| 5         | 0.043 | -2.627   | 6.353 | 179.805 | 0.105 | 0.135   | 0.128 | 1.843    |
| 50        | 0.04  | -2.287   | 6.394 | 177.154 | 0.106 | -1.797  | 0.134 | -10.244  |
| 150       | 0.041 | -7.052   | 6.376 | 171.895 | 0.105 | -5.018  | 0.142 | -31.946  |
| 250       | 0.043 | -11.811  | 6.39  | 166.387 | 0.102 | -7.894  | 0.154 | -50.422  |
| 350       | 0.045 | -16.955  | 6.365 | 160.812 | 0.099 | -10.261 | 0.172 | -64.061  |
| 450       | 0.05  | -20.835  | 6.344 | 155.12  | 0.096 | -12.163 | 0.19  | -75.581  |
| 550       | 0.056 | -28.219  | 6.285 | 149.584 | 0.093 | -13.826 | 0.211 | -84.236  |
| 650       | 0.065 | -33.505  | 6.249 | 143.488 | 0.09  | -14.899 | 0.228 | -91.909  |
| 750       | 0.076 | -40.624  | 6.117 | 137.725 | 0.087 | -15.802 | 0.249 | -97.833  |
| 850       | 0.087 | -45.991  | 6.044 | 132.207 | 0.084 | -16.532 | 0.265 | -102.994 |
| 1000      | 0.11  | -57.035  | 5.777 | 123.596 | 0.081 | -16.693 | 0.293 | -109.497 |
| 1250      | 0.15  | -69.338  | 5.373 | 110.022 | 0.077 | -16.663 | 0.332 | -117.654 |
| 1500      | 0.193 | -79.722  | 4.981 | 97.893  | 0.074 | -17.099 | 0.363 | -123.275 |
| 1750      | 0.34  | -103.07  | 5.104 | 87.096  | 0.066 | -8.827  | 0.35  | -124.261 |
| 2000      | 0.483 | -122.339 | 5.14  | 76.932  | 0.057 | 0.078   | 0.338 | -125.368 |

## 9 TERMINAL CONNECTIONS

Terminal connections for the MT1110 are described in Table 5. The package drawing on page 7 shows the pin configuration.

Table 5 Terminal Connections

| PIN | FUNCTION/<br>SYMBOL | DESCRIPTION       |
|-----|---------------------|-------------------|
| 1   | IN                  | Input             |
| 2   | GND                 | Ground connection |
| 3   | OUT                 | Output/bias       |
| 4   | GND                 | Ground connection |

Preliminary



10 PACKAGE DRAWING

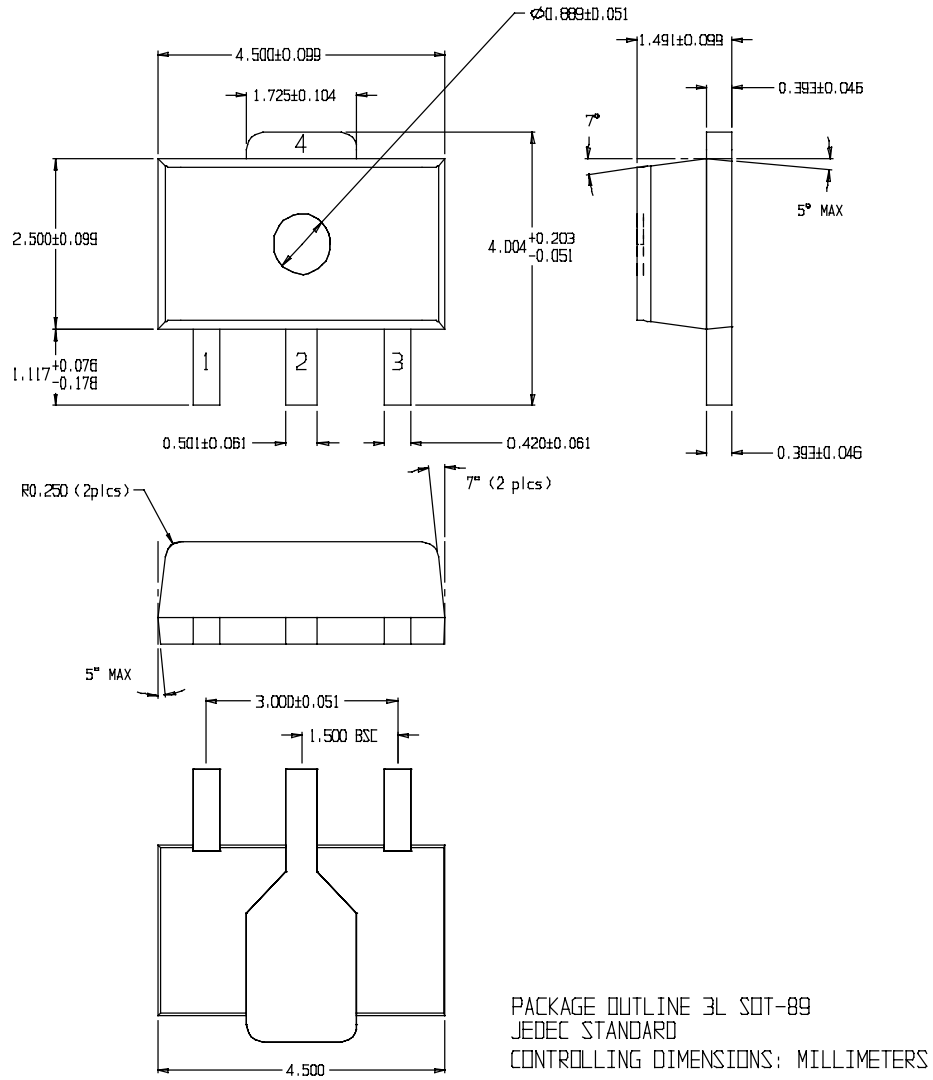

Figure 13 MT1110 Package Drawing

Preliminary



## 11 ORDERING INFORMATION

This part is available in the configuration shown below. Contact one of the offices listed on the following page or your local Microtune representative to place an order.

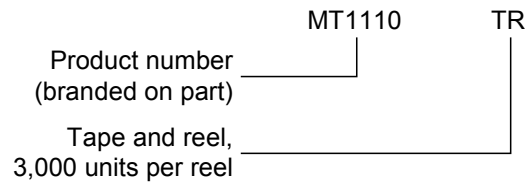

Figure 14 Ordering Information Scheme





## NOTICES

NOTICE - The information in this document is believed to be accurate and reliable. Microtune assumes no responsibility for any consequences arising from the use of this information, nor from any infringement of patents or the rights of third parties, which may result from its use. No license is granted by implication or otherwise under any patent or other rights of Microtune. The information in this publication replaces and supersedes all information previously supplied, and is subject to change without notice. The customer is responsible for assuring that proper design and operating safeguards are observed to minimize inherent and procedural hazards. Microtune assumes no responsibility for applications assistance or customer product design.

NOTICE - The devices described in this document are not authorized for use in medical, life-support equipment, or any other application involving a potential risk of severe property or environmental damage, personal injury, or death without prior express written approval of Microtune. Any such use is understood to be entirely at the user's risk.

TRADEMARKS - Microtune, MicroTuner, and the Microtune logo are trademarks of Microtune, Inc. All other trademarks belong to their respective companies.

PATENTS - Microtune's products are protected by one or more of the following U.S. patents: 5,625,325; 5,648,744; 5,717,730; 5,737,035; 5,739,730; 5,805,988; 5,847,612; 6,100,761; 6,104,242; 6,144,402; 6,163,684; 6,169,569; 6,177,964; 6,218,899 and additional patents pending or filed.

COPYRIGHT - Entire contents Copyright © 2001 Microtune, Inc.

### World Headquarters

Microtune, Inc.  
2201 Tenth Street  
Plano, TX 75074  
USA

Telephone: 972-673-1600  
Fax: 972-673-1602  
Email: [sales@microtune.com](mailto:sales@microtune.com)  
Website: [www.microtune.com](http://www.microtune.com)

### European Headquarters

Microtune GmbH and Co. KG  
Marie Curie Strasse 1  
85055 Ingolstadt / Germany

Telephone: +49-841-9378-011  
Fax: +49-841-9378-010  
Sales Telephone: +49-841-9378-020  
Sales Fax: +49-841-9378-024

### Pan-Asian Headquarters

Microtune, Inc. - Hong Kong  
Silvercord Tower 1, Room 503  
30 Canton Road  
Kowloon, Hong Kong

Telephone: +852-2378-8128  
Fax: +852-2302-0756

For a detailed list of current sales representatives, visit our Web site at [www.microtune.com](http://www.microtune.com).

Preliminary

