

NPN Silicon Planar Epitaxial Transistor

(Pb) Lead(Pb)-Free

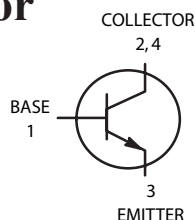

1.BASE
2.COLLECTOR
3.EMITTER
4.COLLECTOR

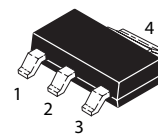

SOT-223

ABSOLUTE MAXIMUM RATINGS ($T_A=25^{\circ}\text{C}$)

Rating	Symbol	Value	Unit
Collector-Emitter Voltage	V_{CEO}	400	V
Collector-Base Voltage	V_{CBO}	500	V
Emitter-Base Voltage	V_{EBO}	6	V
Collector Current (DC)	$I_C(\text{DC})$	300	mA
Total Device Dissipation $T_A=25^{\circ}\text{C}$	P_D	2	W
Junction Temperature	T_j	150	$^{\circ}\text{C}$
Storage, Temperature	T_{stg}	-55 to +150	$^{\circ}\text{C}$

ELECTRICAL CHARACTERISTICS

Characteristics	Symbol	Min	Typ	Max	Unit
Collector-Emitter Breakdown Voltage ($I_C=1\text{mA}$)	$V_{(BR)CEO}$	400	-	-	V
Collector-Base Breakdown Voltage ($I_C=100\mu\text{A}$)	$V_{(BR)CBO}$	500	-	-	V
Emitter-Base Breakdown Voltage ($I_E=10\mu\text{A}$)	$V_{(BR)EBO}$	6	-	-	V
Collector-Emitter Cutoff Current ($V_{CB}=400\text{V}$)	I_{CBO}	-	-	100	nA
Collector Cutoff Current ($V_{CB}=400\text{V}$)	I_{CES}	-	-	500	nA
Emitter-Base Cutoff Current ($V_{EB}=4\text{V}$)	I_{EBO}	-	-	100	nA
DC Current Gain ($V_{CE} = 10\text{V}, I_C = 1\text{mA}$) ($V_{CE} = 10\text{V}, I_C = 10\text{mA}$) ($V_{CE} = 10\text{V}, I_C = 50\text{mA}$) ($V_{CE} = 10\text{V}, I_C = 100\text{mA}$)	h_{FE1} h_{FE2} h_{FE3} h_{FE4}	40 50 45 40	- - - -	- 300 - -	-
Collector-Emitter Saturation Voltages ($I_C = 20\text{mA}, I_B = 2\text{mA}$) ($I_C = 50\text{mA}, I_B = 5\text{mA}$)	$V_{CE(sat)}$	- -	- -	375 750	mV
Base-Emitter Saturation Voltages ($I_C = 10\text{mA}, I_B = 1\text{mA}$)	$V_{BE(sat)}$	-	-	750	mV
Output Capacitance ($V_{CE} = 20\text{Vdc}, f = 1\text{MHz}$)	C_{ob}	-	4	6	pF

Device Marking

PZTA44=44

Characteristics Curve

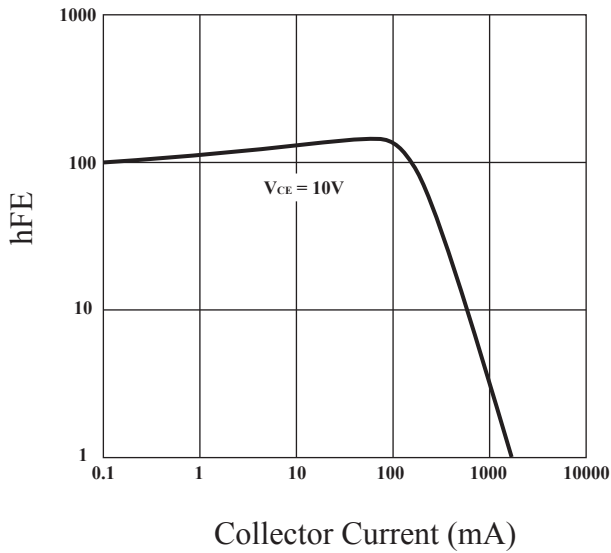

Fig.1 Current Gain & Collector Current

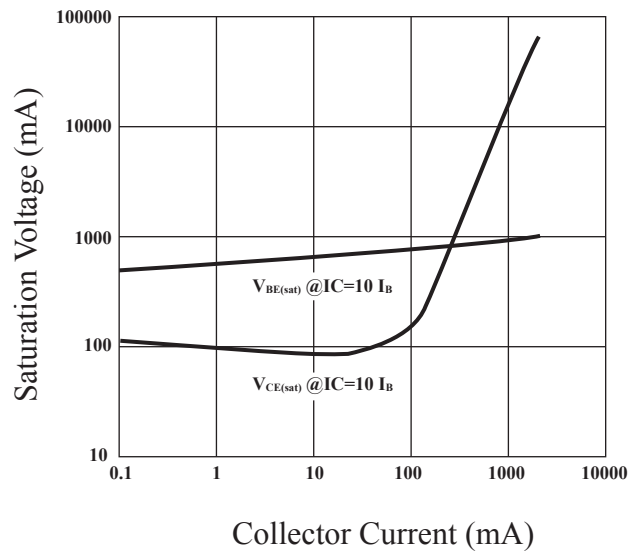

Fig.2 Saturation Voltage & Collector Current

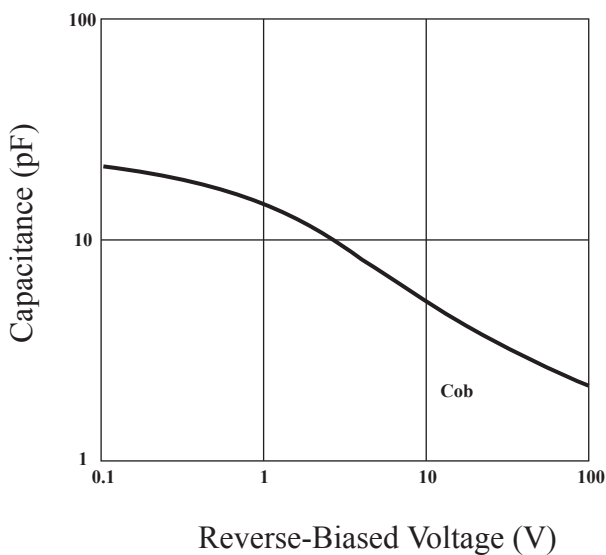

Fig.3 Capacitance & Reverse-Biased Voltage

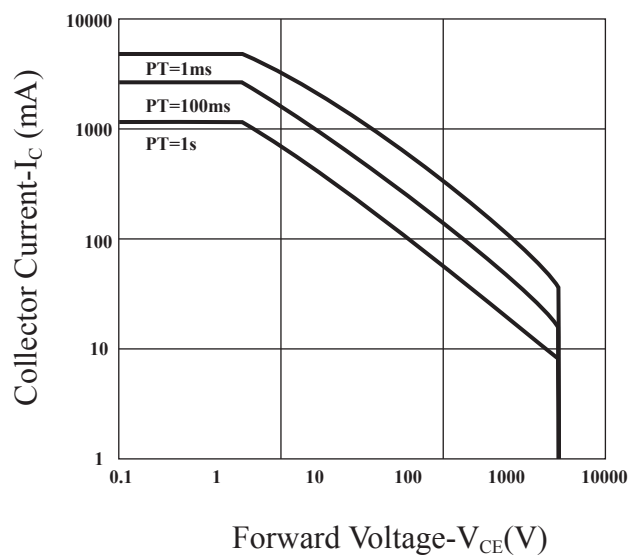
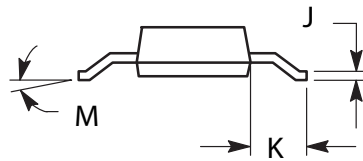
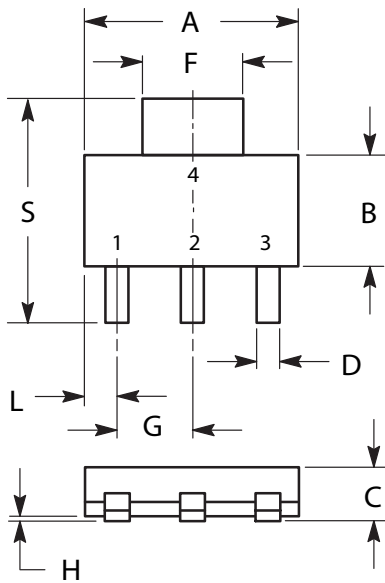

Fig.4 Safe Operation Area

SOT-223 Outline Dimensions

unit:mm



DIM	MILLIMETERS	
	MIN	MAX
A	6.30	6.70
B	3.30	3.70
C	1.50	1.75
D	0.60	0.89
F	2.90	3.20
G	2.20	2.40
H	0.020	0.100
J	0.24	0.35
K	1.50	2.00
L	0.85	1.05
M	0°	10°
S	6.70	7.30