

# N-channel enhancement mode TrenchMOS™ transistor

IRFZ24N

## GENERAL DESCRIPTION

N-channel enhancement mode standard level field-effect power transistor in a plastic envelope using 'trench' technology. The device features very low on-state resistance and has integral zener diodes giving ESD protection up to 2kV. It is intended for use in switched mode power supplies and general purpose switching applications.

## QUICK REFERENCE DATA

SYMBOL	PARAMETER	MAX.	UNIT
$V_{DS}$	Drain-source voltage	55	V
$I_D$	Drain current (DC)	17	A
$P_{tot}$	Total power dissipation	45	W
$T_j$	Junction temperature	175	°C
$R_{DS(ON)}$	Drain-source on-state resistance $V_{GS} = 10\text{ V}$	70	mΩ

## PINNING - TO220AB

PIN	DESCRIPTION
1	gate
2	drain
3	source
tab	drain

## PIN CONFIGURATION

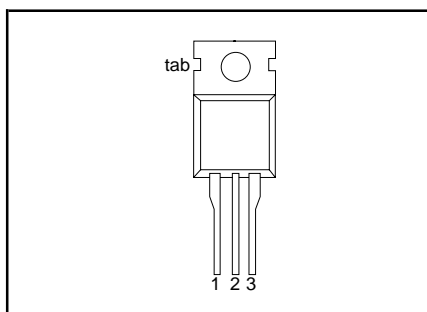

## SYMBOL

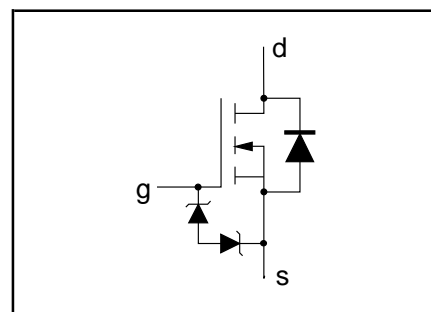

## LIMITING VALUES

Limiting values in accordance with the Absolute Maximum System (IEC 134)

SYMBOL	PARAMETER	CONDITIONS	MIN.	MAX.	UNIT
$V_{DS}$	Drain-source voltage	-	-	55	V
$V_{DGR}$	Drain-gate voltage	$R_{GS} = 20\text{ k}\Omega$	-	55	V
$\pm V_{GS}$	Gate-source voltage	-	-	20	V
$I_D$	Drain current (DC)	$T_{mb} = 25\text{ }^\circ\text{C}$	-	17	A
$I_D$	Drain current (DC)	$T_{mb} = 100\text{ }^\circ\text{C}$	-	12	A
$I_{DM}$	Drain current (pulse peak value)	$T_{mb} = 25\text{ }^\circ\text{C}$	-	68	A
$P_{tot}$	Total power dissipation	$T_{mb} = 25\text{ }^\circ\text{C}$	-	45	W
$T_{stg}, T_j$	Storage & operating temperature	-	- 55	175	°C

## ESD LIMITING VALUE

SYMBOL	PARAMETER	CONDITIONS	MIN.	MAX.	UNIT
$V_C$	Electrostatic discharge capacitor voltage, all pins	Human body model (100 pF, 1.5 kΩ)	-	2	kV

## THERMAL RESISTANCES

SYMBOL	PARAMETER	CONDITIONS	TYP.	MAX.	UNIT
$R_{th\ j-mb}$	Thermal resistance junction to mounting base	-	-	3.3	K/W
$R_{th\ j-a}$	Thermal resistance junction to ambient	in free air	60	-	K/W

## N-channel enhancement mode TrenchMOS™ transistor

IRFZ24N

### STATIC CHARACTERISTICS

T<sub>j</sub> = 25 °C unless otherwise specified

SYMBOL	PARAMETER	CONDITIONS	MIN.	TYP.	MAX.	UNIT
V <sub>(BR)DSS</sub>	Drain-source breakdown voltage	V <sub>GS</sub> = 0 V; I <sub>D</sub> = 0.25 mA; T <sub>j</sub> = -55 °C	55 50	- -	- -	V V
V <sub>GS(TO)</sub>	Gate threshold voltage	V <sub>DS</sub> = V <sub>GS</sub> ; I <sub>D</sub> = 1 mA T <sub>j</sub> = 175 °C T <sub>j</sub> = -55 °C	2.0 1.0 -	3.0 - -	4.0 - 4.4	V V V
I <sub>DSS</sub>	Zero gate voltage drain current	V <sub>DS</sub> = 55 V; V <sub>GS</sub> = 0 V; T <sub>j</sub> = 175 °C	-	0.05	10	μA
I <sub>GSS</sub>	Gate source leakage current	V <sub>GS</sub> = ±10 V; V <sub>DS</sub> = 0 V T <sub>j</sub> = 175 °C	-	0.04	1 500	μA μA
±V <sub>(BR)GSS</sub>	Gate source breakdown voltage	I <sub>G</sub> = ±1 mA; T <sub>j</sub> = 175 °C	16	-	-	V
R <sub>DS(ON)</sub>	Drain-source on-state resistance	V <sub>GS</sub> = 10 V; I <sub>D</sub> = 10 A T <sub>j</sub> = 175 °C	-	60	70 157	mΩ mΩ

### DYNAMIC CHARACTERISTICS

T<sub>mb</sub> = 25 °C unless otherwise specified

SYMBOL	PARAMETER	CONDITIONS	MIN.	TYP.	MAX.	UNIT
g <sub>fs</sub>	Forward transconductance	V <sub>DS</sub> = 25 V; I <sub>D</sub> = 10 A	1	-	-	S
C <sub>iss</sub>	Input capacitance	V <sub>GS</sub> = 0 V; V <sub>DS</sub> = 25 V; f = 1 MHz	-	365	500	pF
C <sub>oss</sub>	Output capacitance		-	110	135	pF
C <sub>rss</sub>	Feedback capacitance		-	60	85	pF
Q <sub>g</sub>	Total gate charge	V <sub>DD</sub> = 44 V; I <sub>D</sub> = 20 A; V <sub>GS</sub> = 10 V	-	-	19	nC
Q <sub>gs</sub>	Gate-source charge		-	-	5.2	nC
Q <sub>gd</sub>	Gate-drain (miller) charge		-	-	7.2	nC
t <sub>d on</sub>	Turn-on delay time	V <sub>DD</sub> = 30 V; I <sub>D</sub> = 10 A;	-	9	14	ns
t <sub>r</sub>	Turn-on rise time	V <sub>GS</sub> = 10 V; R <sub>G</sub> = 10 Ω	-	16	21	ns
t <sub>d off</sub>	Turn-off delay time	Resistive load	-	14	25	ns
t <sub>f</sub>	Turn-off fall time		-	13	20	ns
L <sub>d</sub>	Internal drain inductance	Measured from contact screw on tab to centre of die	-	3.5	-	nH
L <sub>d</sub>	Internal drain inductance	Measured from drain lead 6 mm from package to centre of die	-	4.5	-	nH
L <sub>s</sub>	Internal source inductance	Measured from source lead 6 mm from package to source bond pad	-	7.5	-	nH

### REVERSE DIODE LIMITING VALUES AND CHARACTERISTICS

T<sub>j</sub> = 25 °C unless otherwise specified

SYMBOL	PARAMETER	CONDITIONS	MIN.	TYP.	MAX.	UNIT
I <sub>DR</sub>	Continuous reverse drain current		-	-	17	A
I <sub>DRM</sub>	Pulsed reverse drain current		-	-	68	A
V <sub>SD</sub>	Diode forward voltage	I <sub>F</sub> = 19.7 A; V <sub>GS</sub> = 0 V	-	0.95	1.2	V
t <sub>rr</sub>	Reverse recovery time	I <sub>F</sub> = 19.7 A; -di <sub>F</sub> /dt = 100 A/μs;	-	32	-	ns
Q <sub>rr</sub>	Reverse recovery charge	V <sub>GS</sub> = -10 V; V <sub>R</sub> = 30 V	-	0.12	-	μC

N-channel enhancement mode  
TrenchMOS™ transistor

IRFZ24N

**AVALANCHE LIMITING VALUE**

SYMBOL	PARAMETER	CONDITIONS	MIN.	TYP.	MAX.	UNIT
$W_{DSS}$	Drain-source non-repetitive unclamped inductive turn-off energy	$I_D = 10\text{ A}; V_{DD} \leq 25\text{ V};$ $V_{GS} = 10\text{ V}; R_{GS} = 50\ \Omega; T_{mb} = 25\text{ }^\circ\text{C}$	-	-	30	mJ

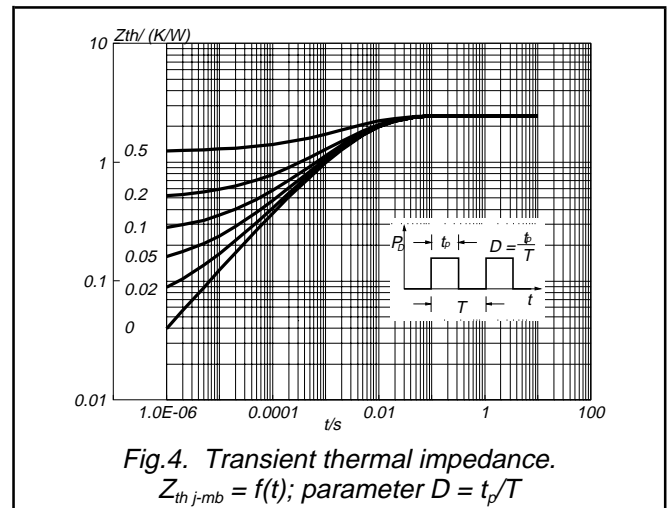
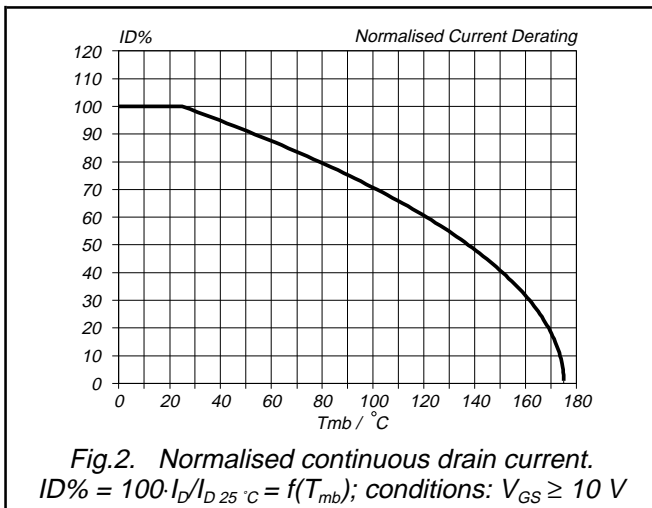
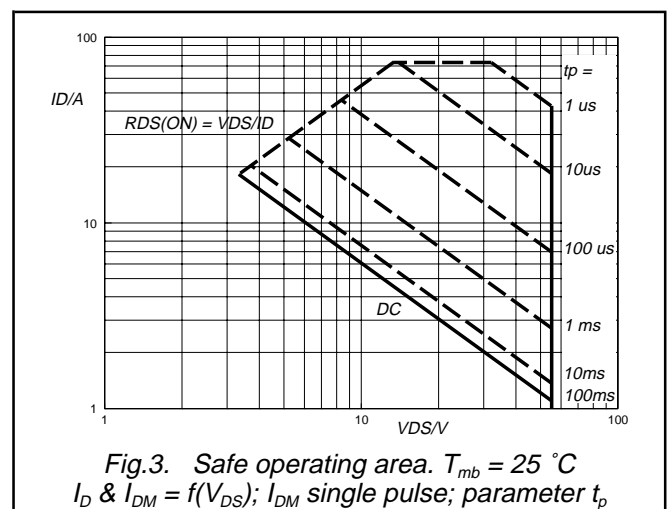
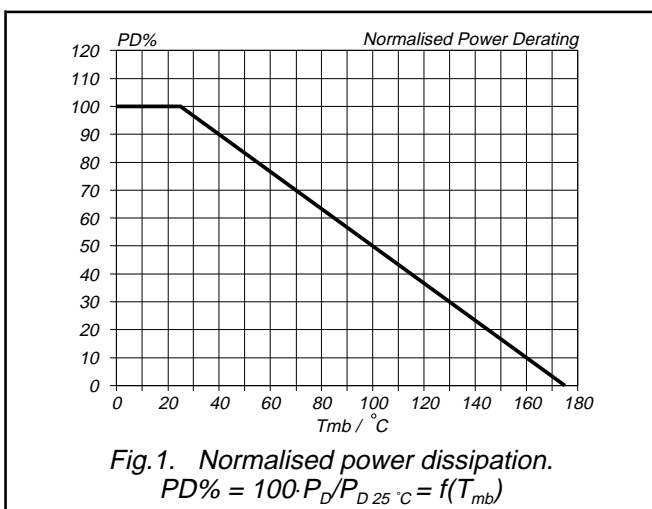

N-channel enhancement mode  
TrenchMOS™ transistor

IRFZ24N

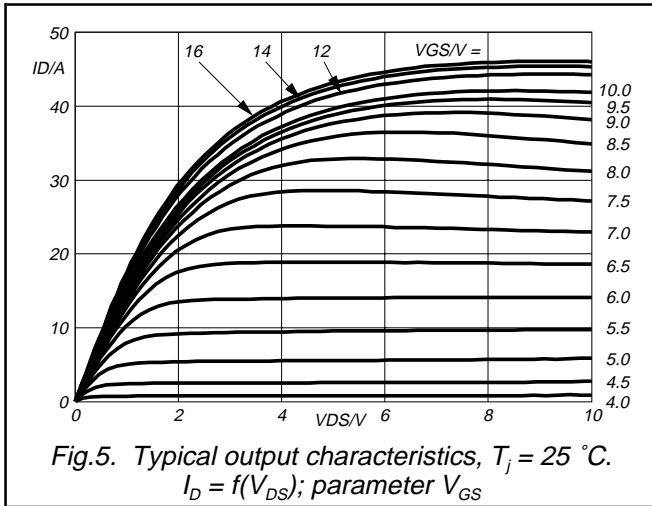

Fig. 5. Typical output characteristics,  $T_j = 25\text{ }^\circ\text{C}$ .  
 $I_D = f(V_{DS})$ ; parameter  $V_{GS}$

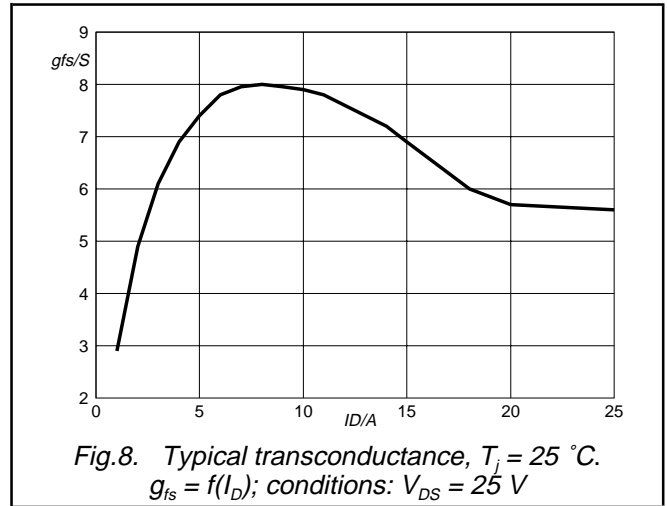

Fig. 8. Typical transconductance,  $T_j = 25\text{ }^\circ\text{C}$ .  
 $g_{fs} = f(I_D)$ ; conditions:  $V_{DS} = 25\text{ V}$

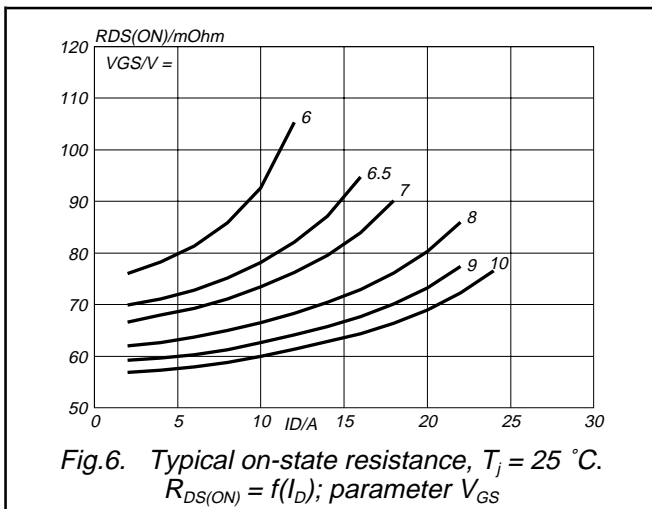

Fig. 6. Typical on-state resistance,  $T_j = 25\text{ }^\circ\text{C}$ .  
 $R_{DS(ON)} = f(I_D)$ ; parameter  $V_{GS}$

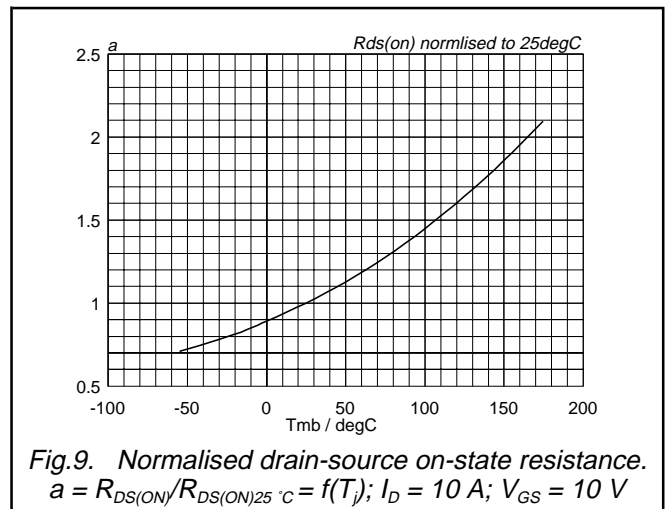

Fig. 9. Normalised drain-source on-state resistance.  
 $a = R_{DS(ON)}/R_{DS(ON)25\text{ }^\circ\text{C}} = f(T_j)$ ;  $I_D = 10\text{ A}$ ;  $V_{GS} = 10\text{ V}$

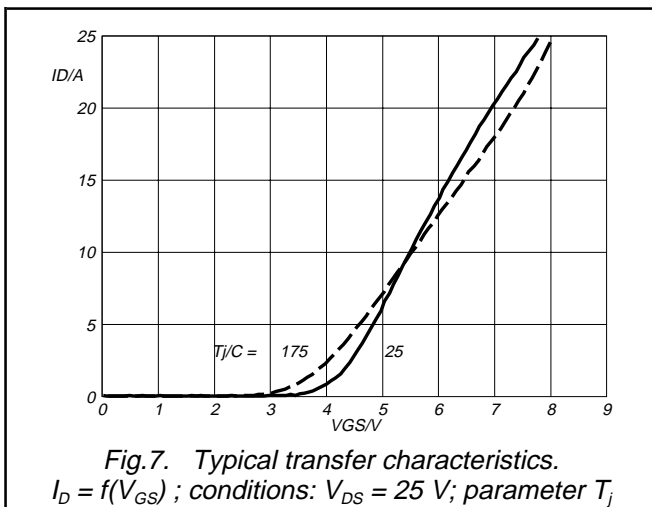

Fig. 7. Typical transfer characteristics.  
 $I_D = f(V_{GS})$ ; conditions:  $V_{DS} = 25\text{ V}$ ; parameter  $T_j$

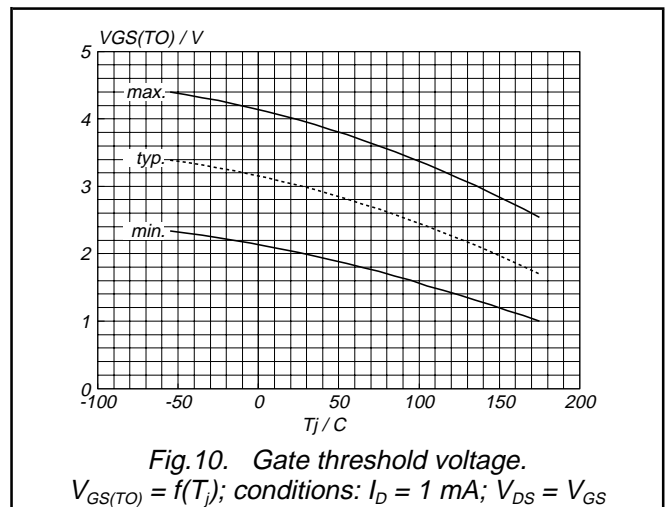
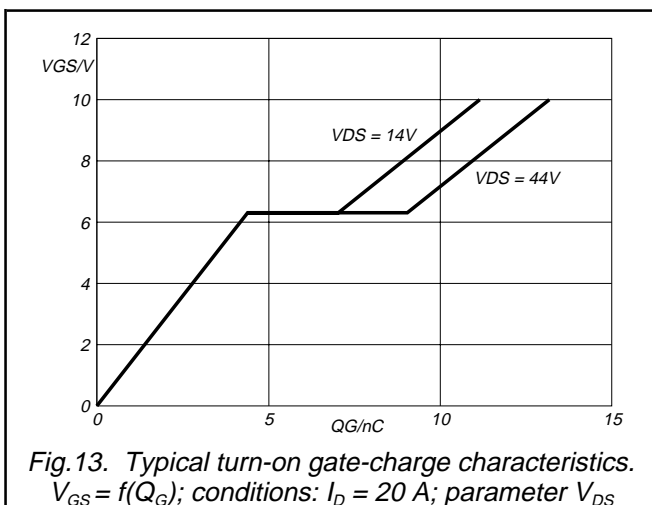
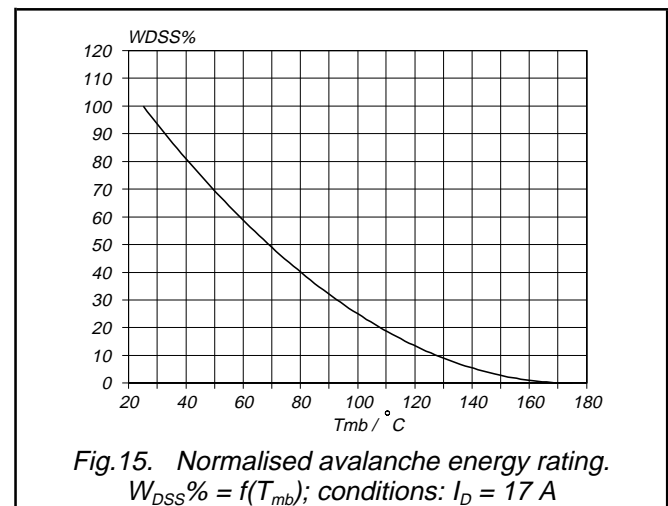
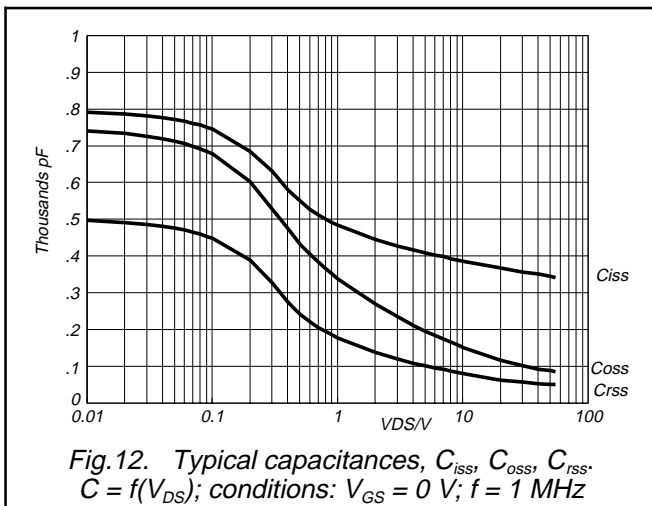
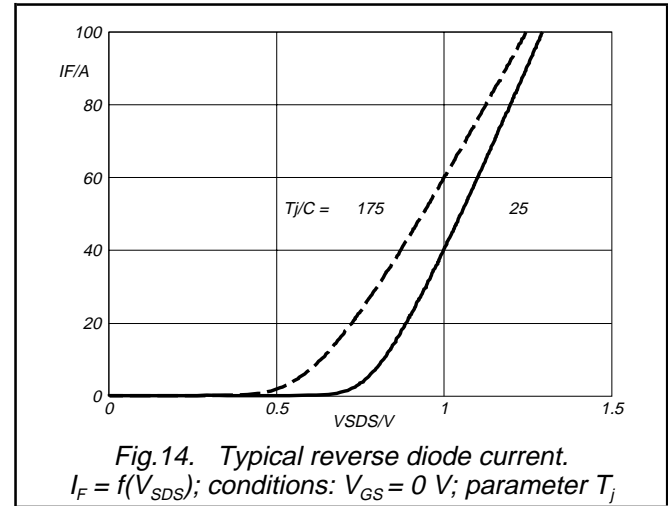

Fig. 10. Gate threshold voltage.  
 $V_{GS(TO)} = f(T_j)$ ; conditions:  $I_D = 1\text{ mA}$ ;  $V_{DS} = V_{GS}$

N-channel enhancement mode  
TrenchMOS™ transistor

IRFZ24N



N-channel enhancement mode  
TrenchMOS™ transistor

IRFZ24N



N-channel enhancement mode  
TrenchMOS™ transistor

IRFZ24N

**MECHANICAL DATA**

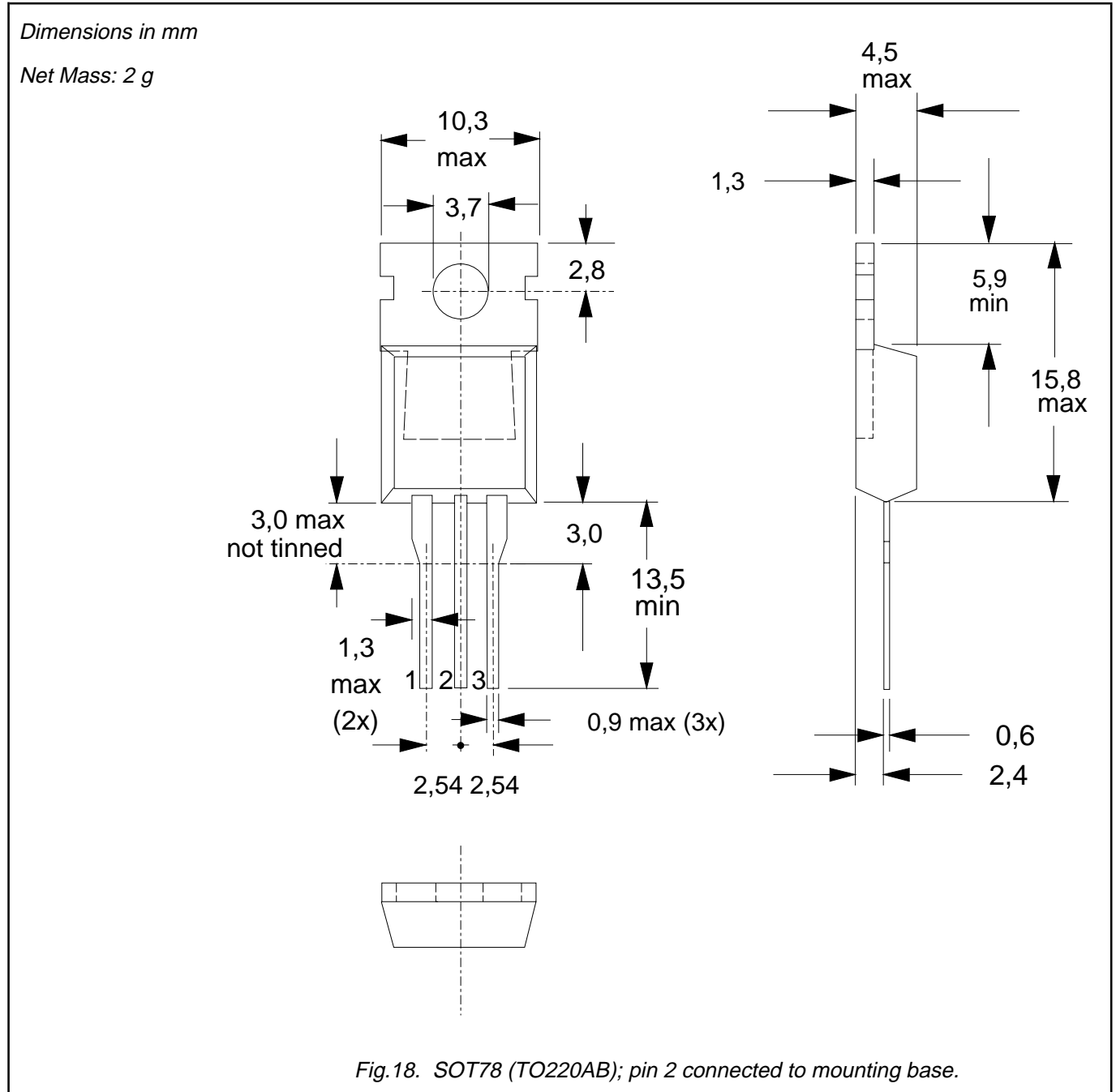

**Notes**

1. Observe the general handling precautions for electrostatic-discharge sensitive devices (ESDs) to prevent damage to MOS gate oxide.
2. Refer to mounting instructions for SOT78 (TO220) envelopes.
3. Epoxy meets UL94 V0 at 1/8".

## N-channel enhancement mode TrenchMOS™ transistor

IRFZ24N

### DEFINITIONS

<b>Data sheet status</b>	
Objective specification	This data sheet contains target or goal specifications for product development.
Preliminary specification	This data sheet contains preliminary data; supplementary data may be published later.
Product specification	This data sheet contains final product specifications.
<b>Limiting values</b>	
Limiting values are given in accordance with the Absolute Maximum Rating System (IEC 134). Stress above one or more of the limiting values may cause permanent damage to the device. These are stress ratings only and operation of the device at these or at any other conditions above those given in the Characteristics sections of this specification is not implied. Exposure to limiting values for extended periods may affect device reliability.	
<b>Application information</b>	
Where application information is given, it is advisory and does not form part of the specification.	
<b>© Philips Electronics N.V. 1999</b>	
All rights are reserved. Reproduction in whole or in part is prohibited without the prior written consent of the copyright owner.	
The information presented in this document does not form part of any quotation or contract, it is believed to be accurate and reliable and may be changed without notice. No liability will be accepted by the publisher for any consequence of its use. Publication thereof does not convey nor imply any license under patent or other industrial or intellectual property rights.	

### LIFE SUPPORT APPLICATIONS

These products are not designed for use in life support appliances, devices or systems where malfunction of these products can be reasonably expected to result in personal injury. Philips customers using or selling these products for use in such applications do so at their own risk and agree to fully indemnify Philips for any damages resulting from such improper use or sale.