

LQ084V1DG21

TFT-LCD Module

(Model No.: LQ084V1DG21)

Spec No.: LD-12X02A

Issue Date: June 4, 2002

PREPARED BY : DATE

C. Murata: June. 6, 02

APPROVED BY : DATE

H. Takahashi

SHARP

SHARP CORPORATION

SPECIFICATION

SPEC No. LD-12X02A

FILE No.

ISSUE : Jun. 4. 2002

PAGE : 18 pages

ENGINEERING DEPT. II

MOBILE LCD DESIGN CENTER

MOBILE LIQUID CRYSTAL DISPLAY GROUP

DEVICE SPECIFICATION FOR

TFT-LCD Module

MODEL No.

LQ084V1DG21

CUSTOMER'S APPROVAL

DATE _____

BY _____

PRESENTED

BY *S. yasuda*

S. YASUDA

DIVISION DUPTY GENERAL MANAGER

ENGINEERING DEPT. II

MOBILE LIQUID CRYSTAL DISPLAY GROUP

SHARP CORPORATION

1. Application

This specification applies to color TFT-LCD module, LQ084V1DG21.

These specification sheets are the proprietary product of SHARP CORPORATION("SHARP) and include materials protected under copyright of SHARP. Do not reproduce or cause any third party to reproduce them in any form or by any means, electronic or mechanical, for any purpose, in whole or in part, without the express written permission of SHARP .

The device listed in these specification sheets was designed and manufactured for use in general electronic equipment.

In case of using the device for applications such as control and safety equipment for transportation(aircraft, trains, automobiles, etc.), rescue and security equipment and various safety related equipment which require higher reliability and safety, take into consideration that appropriate measures such as fail-safe functions and redundant system design should be taken .

Do not use the device for equipment that requires an extreme level of reliability, such as aerospace applications, telecommunication equipment(trunk lines), nuclear power control equipment and medical or other equipment for life support .

SHARP assumes no responsibility for any damage resulting from the use of the device which does not comply with the instructions and the precautions specified in these specification sheets .

Contact and consult with a SHARP sales representative for any questions about this device .

2. Overview

This module is a color active matrix LCD module incorporating amorphous silicon TFT (Thin Film Transistor). It is composed of a color TFT-LCD panel, driver ICs, control circuit and power supply circuit and a backlight unit. Graphics and texts can be displayed on a $640 \times 3 \times 480$ dots panel with 262,144 colors by supplying 18 bit data signals (6bit/color), four timing signals, +3.3V/ +5V DC supply voltage for TFT-LCD panel driving and supply voltage for backlight.

The TFT-LCD panel used for this module is a low-reflection and higher-color-saturation type. Therefore, this module is also suitable for the multimedia use. Optimum viewing direction is 12 o'clock.

This module is the type of wide viewing angle and high brightness($300\text{cd}/\text{m}^2$).

Backlight-driving DC/AC inverter is not built in this module.

3. Mechanical Specifications

Parameter	Specifications	Unit
Display size	21 (8.4") Diagonal	cm
Active area	170.9(H)×129.6(V)	mm
Pixel format	640(H)×480(V)	pixel
	(1 pixel=R+G+B dots)	
Pixel pitch	0.267(H)×0.270(V)	mm
Pixel configuration	R,G,B vertical stripe	
Display mode	Normally white	
Unit outline dimensions *1	216.0(W)×152.4(H)×12.0(D)	mm
Mass	410±20	g
Surface treatment	Anti-glare and hard-coating 3H Haze value = 28%	

*1.Note: excluding backlight cables and mounting tabs.

Outline dimensions is shown in Fig.1

4. Input Terminals

4-1. TFT-LCD panel driving

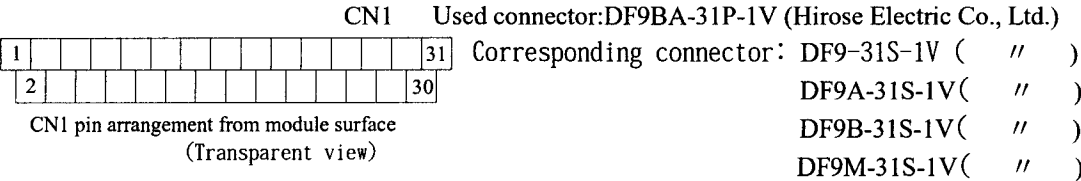

Pin No.	Symbol	Function	Remark
1	GND		
2	CK	Clock signal for sampling each data signal	
3	H sync	Horizontal synchronous signal	【Note1】
4	V sync	Vertical synchronous signal	【Note1】
5	GND		
6	R0	R E D data signal(LSB)	
7	R1	R E D data signal	
8	R2	R E D data signal	
9	R3	R E D data signal	
10	R4	R E D data signal	
11	R5	R E D data signal(MSB)	
12	GND		
13	G0	G R E E N data signal(LSB)	
14	G1	G R E E N data signal	
15	G2	G R E E N data signal	
16	G3	G R E E N data signal	
17	G4	G R E E N data signal	
18	G5	G R E E N data signal(MSB)	
19	GND		
20	B0	B L U E data signal(LSB)	
21	B1	B L U E data signal	
22	B2	B L U E data signal	
23	B3	B L U E data signal	
24	B4	B L U E data signal	
25	B5	B L U E data signal(MSB)	
26	GND		
27	ENAB	Signal to settle the horizontal display position	【Note2】
28	Vcc	+3.3/+5.0V power supply	
29	Vcc	+3.3/+5.0V power supply	
30	R/L	Horizontal display mode select signal	【Note3】
31	U/D	Vertical display mode select signal	【Note4】

※The shielding case is not connected with GND.

【Note1】 480 line, 400 line or 350 line mode is selected by the polarity combination of the both synchronous signals.

Mode	480 lines	400 lines	350 lines
H sync	negative	negative	positive
V sync	negative	positive	negative

【Note2】 The horizontal display start timing is settled in accordance with a rising timing of ENAB signal. In case ENAB is fixed "Low", the horizontal start timing is determined as described in 7-2. Don't keep ENAB "High" during operation.

【Note3】 R/L=High、U/D=Low

R/L=Low、U/D=Low

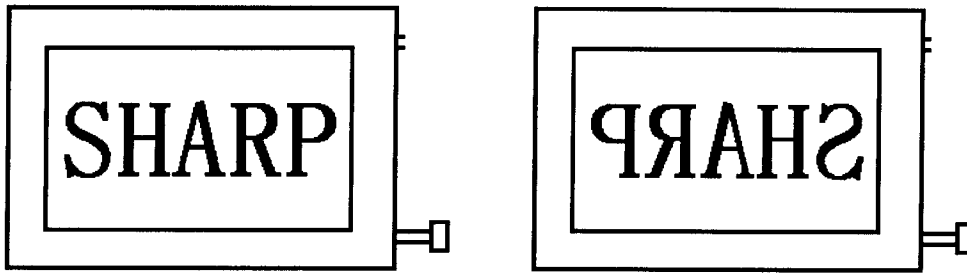

【Note4】 R/L=High、U/D=High

R/L=Low、U/D=High

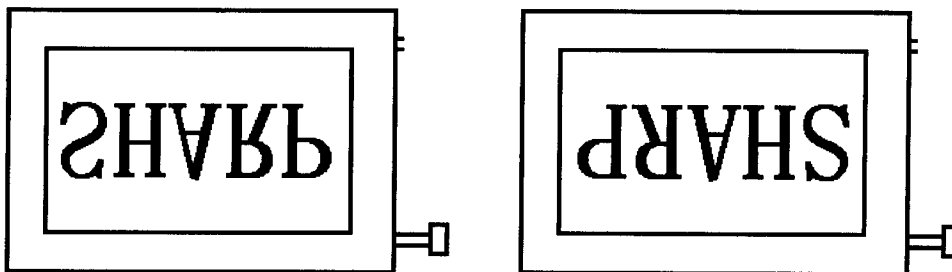

4-2. Backlight driving

Used connector : BHR-03VS-1(JST)

CNA, CNB

Corresponding connector : SM02(8.0)B-BHS(JST)

Pin no.	Symbol	function
1	V _{HIGH}	Power supply for lamp (High voltage side)
2	NC	This is electrically opened.
3	V _{LOW}	Power supply for lamp (Low voltage side)

5. Absolute Maximum Ratings

Parameter	Symbol	Condition	Ratings	Unit	Remark
Input voltage	V _I	Ta=25°C	-0.3 ~ V _{CC} +0.3	V	【Note1】
supply voltage	V _{CC}	Ta=25°C	0 ~ +6	V	—
Storage temperature	T _{stg}	—	-25 ~ +70	°C	【Note2】
Operating temperature (Panel)	T _{opa}	—	0 ~ +63		
Operating temperature (Ambient)	T _{opp}	—	0 ~ +60	°C	

【Note1】 CK,R0~R5,G0~G5,B0~B5,Hsync,Vsync,ENAB, R/L, U/L

【Note2】 Humidity : 95%RH Max. at Ta≤40°C.

Maximum wet-bulb temperature at 39°C or less at Ta>40°C.

No condensation.

6. Electrical Characteristics

6-1. TFT-LCD panel driving

Ta=25°C

Parameter	Symbol	Min.	Typ.	Max.	Unit	Remark
3.3V Supply voltage	Vcc	+3.0	+3.3	+3.6	V	【Note1】
5.0V Supply voltage	Vcc	+4.5	+5.0	+5.5	V	
Current dissipation	Icc	—	410	460	mA	【Note2】
Permissive input ripple voltage	V _{RF}	—	—	100	mVp-p	V _{cc} =+3.3V
Input voltage (Low)	V _{IL}	—	—	0.3V _{cc}	V	【Note3】
Input voltage (High)	V _{IH}	0.7V _{cc}	—	—	V	
Input current (low)	I _{OL1}	—	—	1.0	μA	V _I =0V 【Note4】
	I _{OL2}	—	—	60.0	μA	V _I =0V 【Note5】
Input current (High)	I _{OH1}	—	—	1.0	μA	V _I =V _{cc} 【Note6】
	I _{OH2}	—	—	60.0	μA	V _I =V _{cc} 【Note7】

【NOTE 1】

Vcc-turn-on conditions

$$0 < T1 \leq 15 \text{ ms}$$

$$0 < T2 \leq 20 \text{ ms}$$

$$0 < T3 \leq 1 \text{ s}$$

$$1 \text{ s} < T4$$

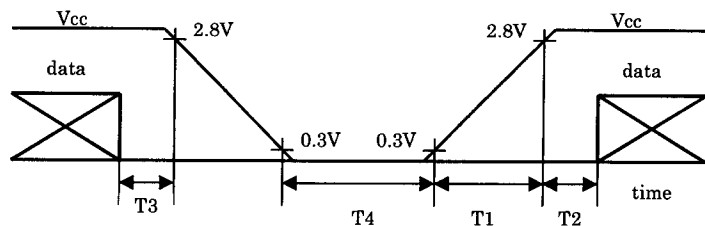

Vcc-dip conditions

- 1) $2.7 \text{ V} \leq V_{cc} < 3.0 \text{ V}$
 $t_d \leq 10 \text{ ms}$
- 2) $V_{cc} < 2.7 \text{ V}$

Vcc-dip conditions should also follow
The Vcc-turn-on conditions

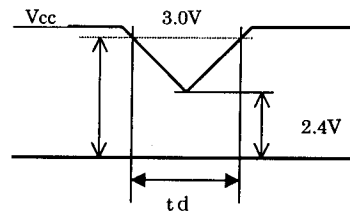

【Note2】 Typical current situation : 16-gray-bar pattern.

480 line mode

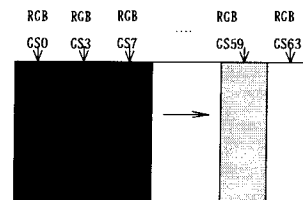
V_{cc}=+3.3V【Note3】 CK,R0~R5,G0~G5,B0~B5,Hsync,Vsync,ENAB,
R/L,U/D

【Note4】 CK,R0~R5,G0~G5,B0~B5,Hsync,Vsync,ENAB

【Note5】 R/L

【Note6】 CK,R0~R5,G0~G5,B0~B5,Hsnc,Vsync

【Note7】 ENAB, U/D

6-2. Backlight driving

The backlight system is an edge-lighting type with single CCFT (Cold Cathode Fluorescent Tube). The characteristics of single lamp are shown in the following table.

Ta=25°C

Parameter	Symbol	Min.	Typ.	Max.	Unit	Remark
Lamp current	IL	2.0	6.0	6.5	mArms	【Note1】
Lamp power consumption	PL	—	4.1	—	W	【Note2】
Lamp frequency	FL	20	45	70	KHz	【Note3】
Kick-off voltage	Vs	—	—	1300	Vrms	Ta=25°C
		—	—	1500	Vrms	Ta =0°C 【Note4】
Lamp life time	LL	—	50000	—	hour	【Note5】

【Note1】 Lamp current is measured with current meter for high frequency as shown below.

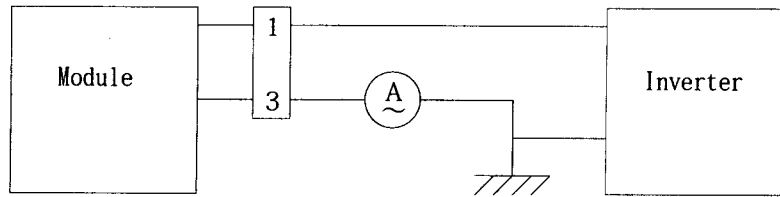

* 3pin is V_{LOW}

【Note2】 At the condition of $Y_L = 300\text{cd/m}^2$

【Note3】 Lamp frequency may produce interference with horizontal synchronous frequency, and this may cause beat on the display. Therefore lamp frequency shall be detached as much as possible from the horizontal synchronous frequency and from the harmonics of horizontal synchronous to avoid interference.

【Note4】 The open output voltage of the inverter shall be maintained for more than 1sec; otherwise the lamp may not be turned on.

【Note5】 Since lamp is consumables, the life time written above is referencial value and it is not guaranteed in this specification sheet by SHARP.

Lamp life time is defined that it applied either ① or ② under this condition
(Continuous turning on at Ta=25°C, IL=6mArms)

- ① Brightness becomes 50% of the original value under standard condition.
- ② Kick-off voltage at Ta=0°C exceeds maximum value, 1500 Vrms.

In case of operating under lower temp environment, the lamp exhaustion is accelerated and the brightness becomes lower. (Continuous operating under for around 1 month under lower temp condition may reduce the brightness to half of the original brightness.)

In case of such usage under lower temp environment, periodical lamp exchange is recommended.

Note) The performance of the backlight, for example life time or brightness, is much influenced by the characteristics of the DC-AC inverter for the lamp. When you design or order the inverter, please make sure that a poor lighting caused by the mismatch of the backlight and the inverter (miss-lighting, flicker, etc.) never occur. when you confirm it, the module should be operated in the same condition as it is installed in your instrument.

Recommended inverter is "CXA-L0612A-VJL(TDK corporation)".

7. Timing Characteristics of input signals

Timing diagrams of input signal are shown in Fig.2 - ①~③ .

7-1. Timing characteristics

Parameter		Symbol	Mode	Min.	Typ.	Max.	Unit	Remark
Clock	Frequency	1/Tc	all	—	25.18	28.33	MHz	
	High time	Tch	"	5	—	—	ns	
	Low time	Tcl	"	10	—	—	ns	
Data	Setup time	Tds	"	5	—	—	ns	
	Hold time	Tdh	"	10	—	—	ns	
Horizontal sync. signal	Cycle	TH	"	30.00	31.78	—	μs	
			"	750	800	900	clock	
	Pulse width	THp	"	2	96	200	clock	
Vertical sync. signal	Cycle	TV	480	515	525	560	line	
			400	446	449	480	line	
			350	447	449	510	line	
	Pulsewidth	TVp	all	1	—	34	line	
Horizontal display period		THd	"	640	640	640	clock	
Hsync-Clock phase difference		THc	"	10	—	Tc-10	ns	
Hsync-Vsync phase difference		TVh	"	0	—	TH-THp	clock	

Note) In case of lower frequency, the deterioration of display quality, flicker etc., may be occurred.

7-2. Horizontal display position

The horizontal display position is determined by ENAB signal and the input data corresponding to the rising edge of ENAB signal is displayed at the left end of the active area.

Parameter		symbol	Min.	Typ.	Max.	Unit	Remark
Enable signal	Setup time	Tes	5	—	Tc-10	ns	
	Pulse width	Tep	2	640	640	clock	
Hsync-Enable signal phase difference		THE	44	—	TH-664	clock	

Note) When ENAB is fixed "Low", the display starts from the data of C104(clock) as shown

in Fig.2-①~③. Be careful that the module does not work when ENAB is fixed "High".

7-3. Vertical display position

The vertical display position is automatically centered in the active area at each mode of VGA ,480-,400-, and 350-line mode . Each mode is selected depending on the polarity of the synchronous signals described in 4-1(Note1).

In each mode ,the data of TVn is displayed at the top line of the active area. And the display position will be centered on the screen like the following figure when the period of vertical synchronous signal, TV,is typical value.

In 400-,and 350-line mode,the data in the vertical data invalid period is also displayed, So ,inputting all data "0" is recommended during vertical data invalid period.

ENAB signal has no relation to the vertical display position.

Mode	V-data start(TVs)	V-data period(TVd)	V-display start(TVn)	V-display period	Unit	Remark
480	34	480	34	480	line	
400	34	400	443-TV	480	line	
350	61	350	445-TV	480	line	

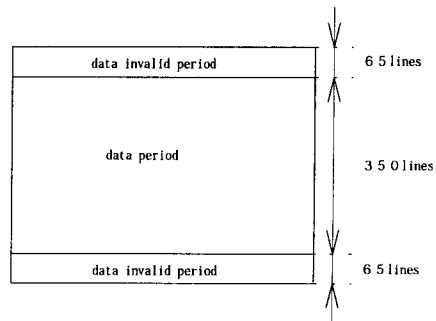
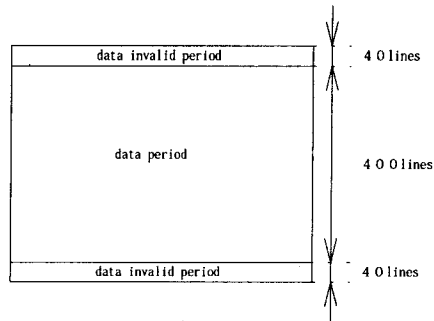

7-4. Input Data Signals and Display Position on the screen

Display position of input data (480 lines mode)
(H, V)

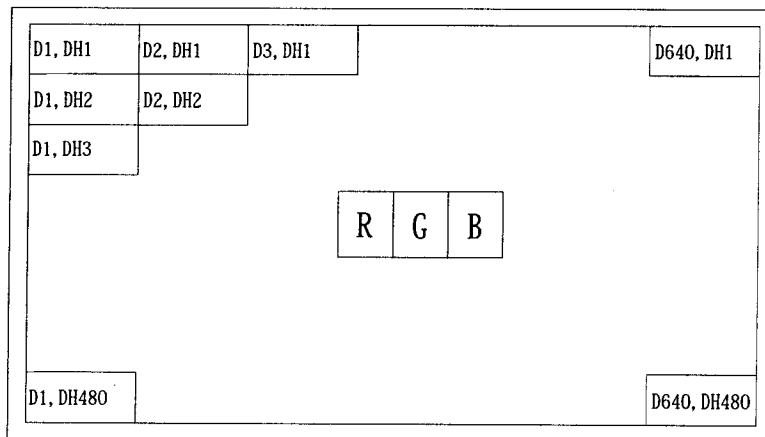

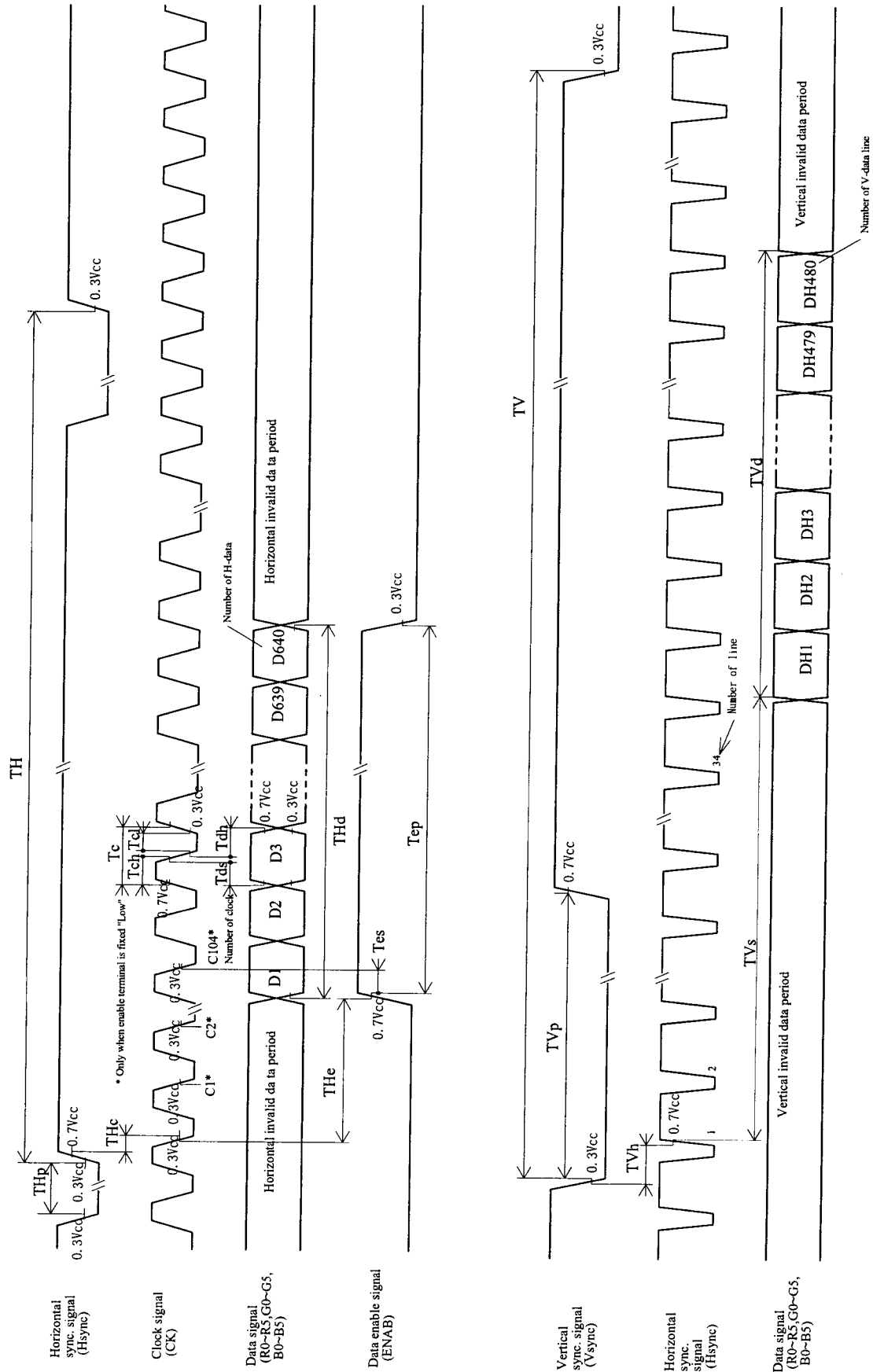

Fig 2-1 Input signal waveforms (480 line m)

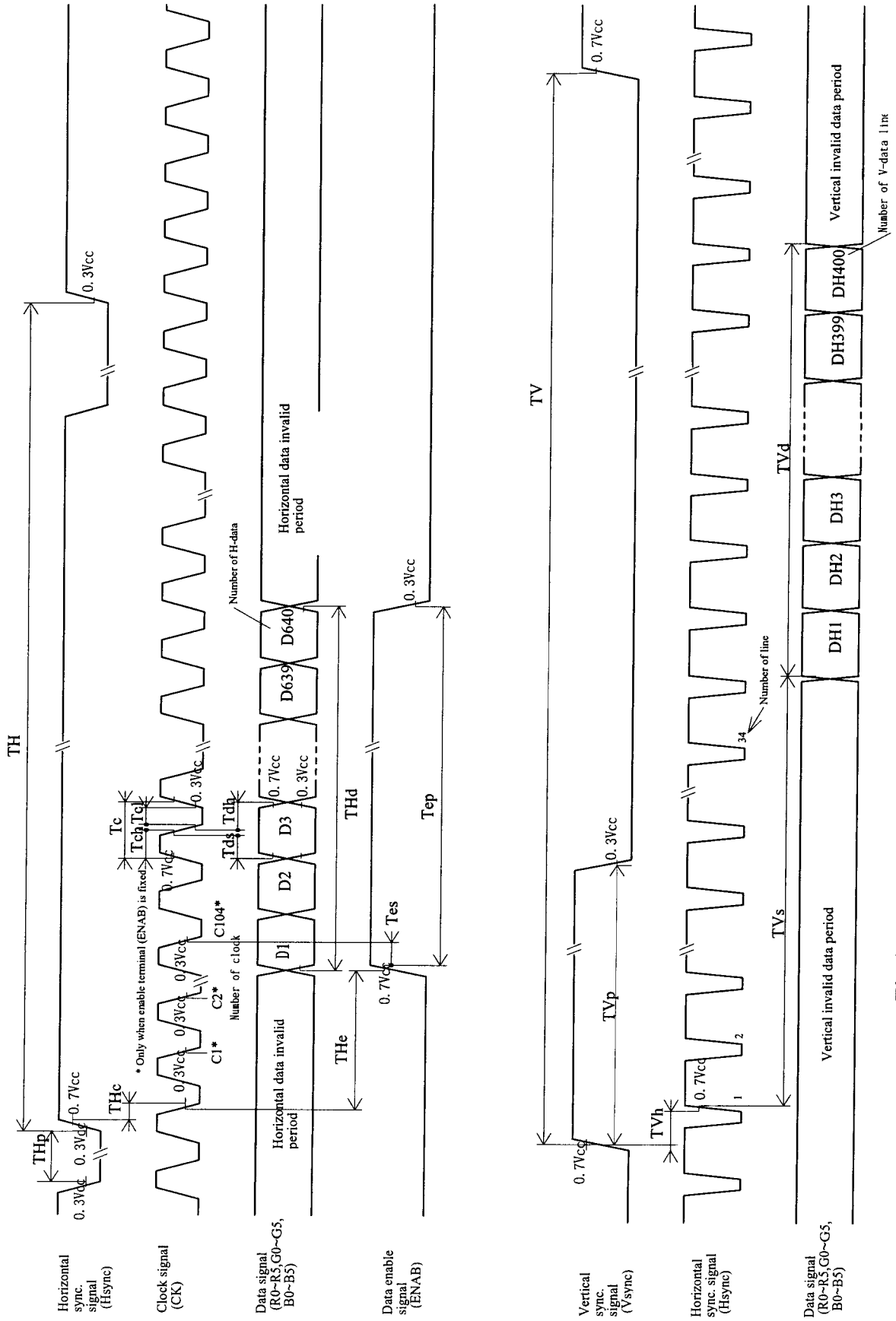

Fig.2-2 Input signal waveforms (400 line)

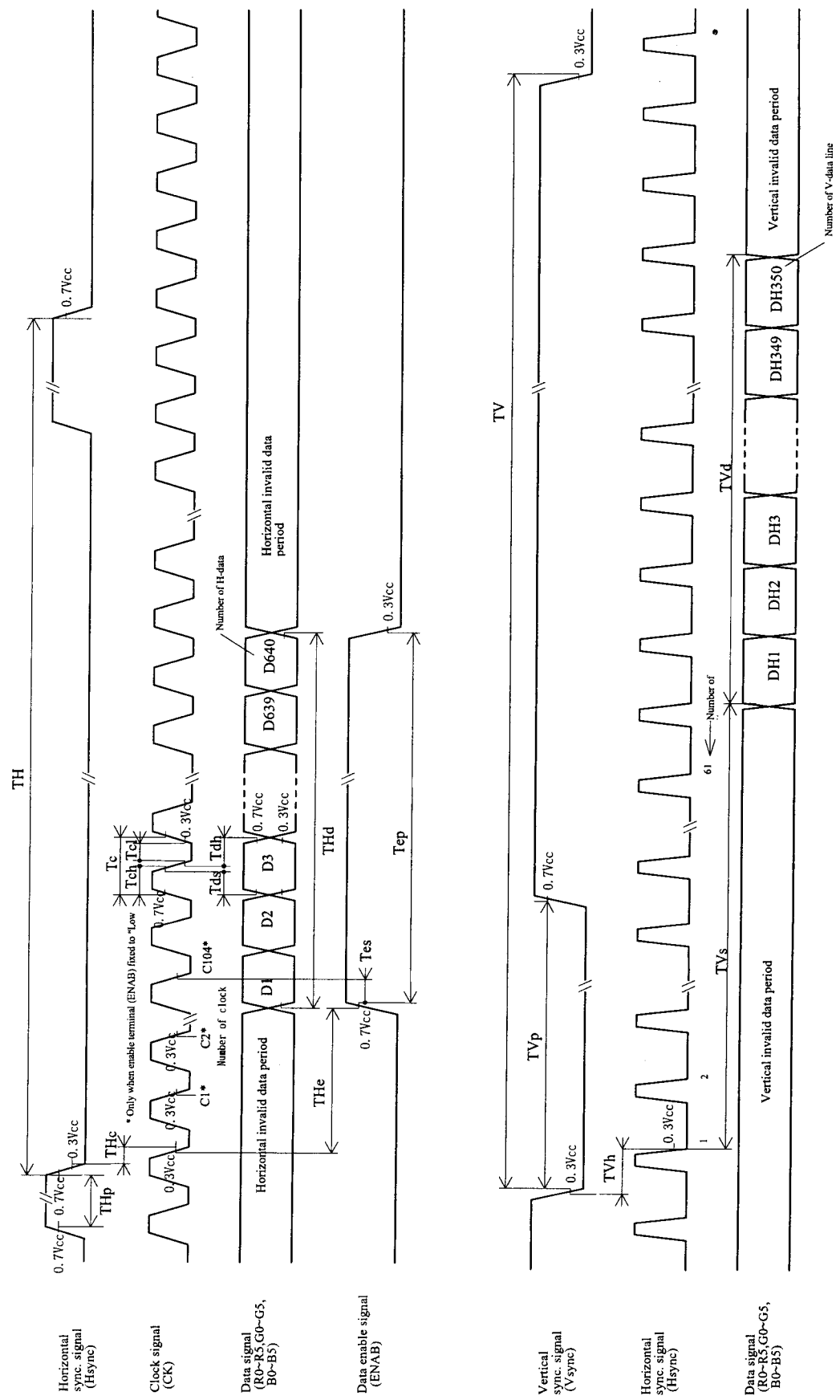

Fig.2-3 Input signal waveforms (350 line mod)

8. Input Signals, Basic Display Colors and Gray Scale of Each Color

	Colors & Gray scale	Data signal																		
		Gray Scale	RA0	RA1	RA2	RA3	RA4	RA5	GA0	GA1	GA2	GA3	GA4	GA5	BA0	BA1	BA2	BA3	BA4	BA5
			RB0	RB1	RB2	RB3	RB4	RB5	GB0	GB1	GB2	GB3	GB4	GB5	BB0	BB1	BB2	BB3	BB4	BB5
Basic Color	Black	—	0	0	0	0	0	0	0	0	0	0	0	0	0	0	0	0	0	0
	Blue	—	0	0	0	0	0	0	0	0	0	0	0	0	1	1	1	1	1	1
	Green	—	0	0	0	0	0	0	1	1	1	1	1	1	0	0	0	0	0	0
	Cyan	—	0	0	0	0	0	0	1	1	1	1	1	1	1	1	1	1	1	1
	Red	—	1	1	1	1	1	1	0	0	0	0	0	0	0	0	0	0	0	0
	Magenta	—	1	1	1	1	1	1	0	0	0	0	0	0	1	1	1	1	1	1
	Yellow	—	1	1	1	1	1	1	1	1	1	1	1	1	0	0	0	0	0	0
	White	—	1	1	1	1	1	1	1	1	1	1	1	1	1	1	1	1	1	1
Gray Scale of Red	Black	GS0	0	0	0	0	0	0	0	0	0	0	0	0	0	0	0	0	0	0
	↑	GS1	1	0	0	0	0	0	0	0	0	0	0	0	0	0	0	0	0	0
	Darker	GS2	0	1	0	0	0	0	0	0	0	0	0	0	0	0	0	0	0	0
	↑	↓			↓					↓					↓					
	↓	↓			↓					↓					↓					
	Brighter	GS61	1	0	1	1	1	1	0	0	0	0	0	0	0	0	0	0	0	0
	↓	GS62	0	1	1	1	1	1	0	0	0	0	0	0	0	0	0	0	0	0
	Red	GS63	1	1	1	1	1	1	0	0	0	0	0	0	0	0	0	0	0	0
Gray Scale of Green	Black	GS0	0	0	0	0	0	0	0	0	0	0	0	0	0	0	0	0	0	0
	↑	GS1	0	0	0	0	0	0	1	0	0	0	0	0	0	0	0	0	0	0
	Darker	GS2	0	0	0	0	0	0	0	1	0	0	0	0	0	0	0	0	0	0
	↑	↓			↓					↓					↓					
	↓	↓			↓					↓					↓					
	Brighter	GS61	0	0	0	0	0	0	1	0	1	1	1	1	0	0	0	0	0	0
	↓	GS62	0	0	0	0	0	0	0	1	1	1	1	1	0	0	0	0	0	0
	Green	GS63	0	0	0	0	0	0	1	1	1	1	1	1	0	0	0	0	0	0
Gray Scale of Blue	Black	GS0	0	0	0	0	0	0	0	0	0	0	0	0	0	0	0	0	0	0
	↑	GS1	0	0	0	0	0	0	0	0	0	0	0	0	1	0	0	0	0	0
	Darker	GS2	0	0	0	0	0	0	0	0	0	0	0	0	0	1	0	0	0	0
	↑	↓			↓					↓					↓					
	↓	↓			↓					↓					↓					
	Brighter	GS61	0	0	0	0	0	0	0	0	0	0	0	0	1	0	1	1	1	1
	↓	GS62	0	0	0	0	0	0	0	0	0	0	0	0	0	1	1	1	1	1
	Blue	GS63	0	0	0	0	0	0	0	0	0	0	0	0	1	1	1	1	1	1

0 : Low level voltage, 1 : High level voltage

Each basic color can be displayed in 64 gray scales from 6 bit data signals. According to the combination of total 18 bit data signals, the 262,144-color display can be achieved on the screen.

9. Optical Characteristics

Ta=25°C, Vcc=+5V

Parameter		Symbol	Condition	Min	Typ	Max	Unit	Remark	
Viewing Angle Range	Horizontal	$\theta 21, \theta 22$	$C R \geq 10$	45	55	—	Deg.	【Note 1, 4】	
	Vertical	$\theta 11$		45	55	—	Deg.		
		$\theta 12$		30	40	—	Deg.		
Contrast ratio		C R	Best Viewing Angle	—	250	—	—	【Note 2, 4】	
Response Time	Rise	τr	$\theta = 0^\circ$	—	20	—	m s	【Note 3, 4】	
	Decay	τd		—	40	—	m s		
Chromaticity of White		x		—	0.319	—		【Note4】	
		y		—	0.329	—			
Luminance of white		Y_L			240	300	—	cd/m ²	
White Uniformity		δw			—	—	1.45	—	【Note5】
Viewing Angle range as a Brightness Definition	Horizontal	$\theta 21, \theta 22$	50% of the maximum brightness	—	45	—	Deg.	【Note1】	
	Vertical	$\theta 11$		—	30	—	Deg.		
		$\theta 12$		—	35	—	Deg.		

※The measurement shall be executed 30 minutes after lighting at rating. (typical condition:L=6.0mArms)

The optical characteristics shall be measured in a dark room or equivalent state with the method shown in Fig.3 below.

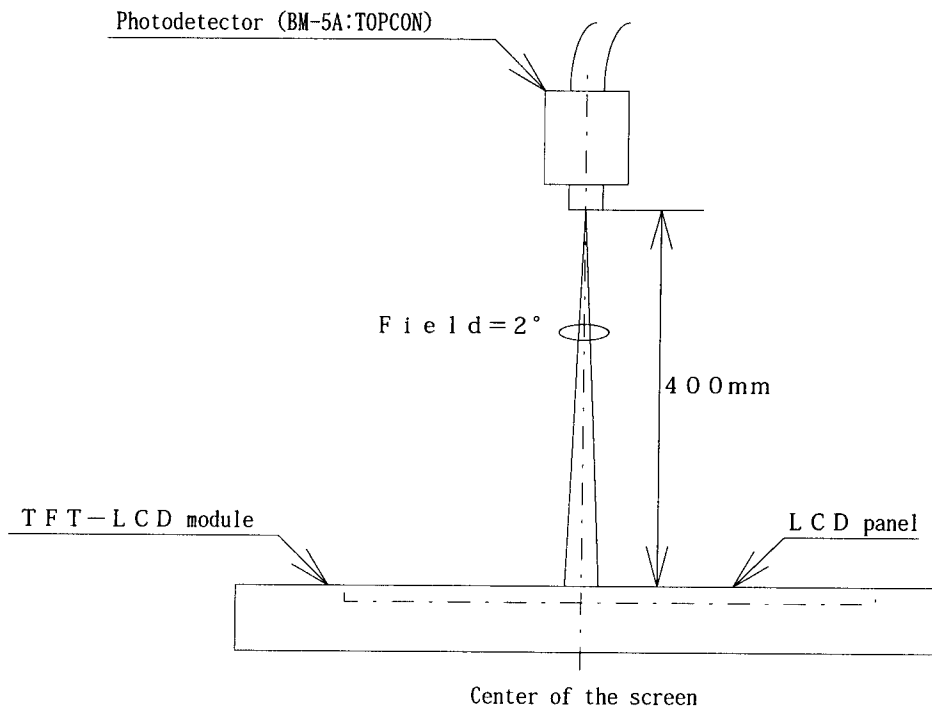
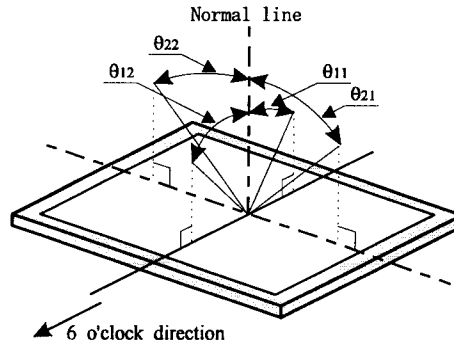

Fig.3 Optical characteristics measurement method

【Note1】 Definitions of viewing angle range:



【Note2】 Definition of contrast ratio:

The contrast ratio is defined as the following.

$$\text{Contrast Ratio (CR)} = \frac{\text{Luminance (brightness) with all pixels white}}{\text{Luminance (brightness) with all pixels black}}$$

【Note3】 Definition of response time:

The response time is defined as the following figure and shall be measured by switching the input signal for "black" and "white".

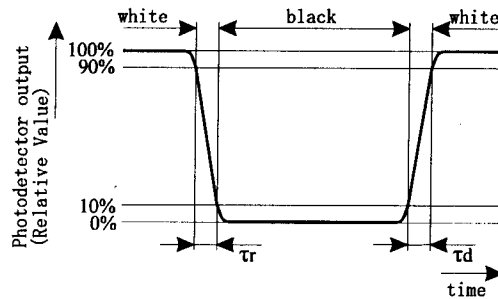

【Note4】 This shall be measured at center of the screen.

【Note5】 Definition of white uniformity:

White uniformity is defined as the following with five measurements (A~E).

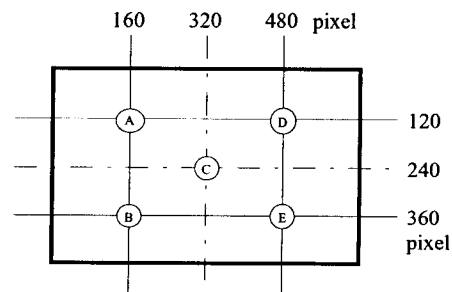

$$\delta_w = \frac{\text{Maximum Luminance of five points (brightness)}}{\text{Minimum Luminance of five points (brightness)}}$$

10. Display Quantity

The display quality of the color TFT-LCD module shall be in compliance with the Incoming Inspection Standard.

11. Handling Precautions

- a) Be sure to turn off the power supply when inserting or disconnecting the cable.
- b) Be sure to design the cabinet so that the module can be installed without any extra stress such as warp or twist.
- c) Since the front polarizer is easily damaged, pay attention not to scratch it.
- d) Wipe off water drop immediately. Long contact with water may cause discoloration or spots.
- e) When the panel surface is soiled, wipe it with absorbent cotton or other soft cloth.
- f) Since the panel is made of glass, it may break or crack if dropped or bumped on hard surface.
Handle with care.
- g) Since CMOS LSI is used in this module, take care of static electricity and injure the human earth when handling.
- h) Observe all other precautionary requirements in handling components.
- i) This module has its circuitry PCBs on the rear side and should be carefully handled in order not to be stressed.
- j) Laminated film is attached to the module surface to prevent it from being scratched. Peel the film off slowly, just before the use, with strict attention to electrostatic charges. Ionized air shall be blown over during the action. Blow off 'dust' on the polarizer by using an ionized nitrogen gun etc.
- k) The polarizer surface on the panel is treated with Anti-Glare for low reflection. In case of attaching protective board over the LCD. Be careful about the optical interface fringe etc.
Which degrades display quality.
- l) Connect GND to 4 place of mounting holes to stabilize against EMI and external noise.
- m) There are high voltage portions on the backlight and very dangerous. Careless touch may lead to electrical shock. When exchange lamps or service. Turn off the power without fail.
- n) Be sure not to apply tensile stress to the lamp lead cable.

12. Packing form

- a) Piling number of cartons : MAX 8
- b) Package quantity in one carton : 20 pcs
- c) Carton size : 483(W) × 275(D) × 330(H) mm
- d) Total mass of 1carton filled with full modules : 10.5kg

13. Reliability test items

No.	Test item	Conditions
1	High temperature storage test	Ta=70°C 240h
2	Low temperature storage test	Ta=-25°C 240h
3	High temperature & high humidity operation test	Ta=40°C ; 95%RH 240h (No condensation)
4	High temperature operation test	Ta=60°C 240h
5	Low temperature operation test	Ta=0°C 240h
6	Vibration test (non- operating)	Frequency: 10~57Hz/Vibration width (one side):0.075mm : 58~500Hz/Gravity:9.8m/s ² Sweep time : 11 minutes Test period : 3 hours (1 hour for each direction of X,Y,Z)
7	Shock test (non- operating)	Max. gravity : 490m/s ² Pulse width : 11ms, half sine wave Direction : ±X,±Y,±Z once for each direction.

【Result Evaluation Criteria】

Under the display quality test conditions with normal operation state, these shall be no change which may affect practical display function.

14. Others

1) Lot No Label:

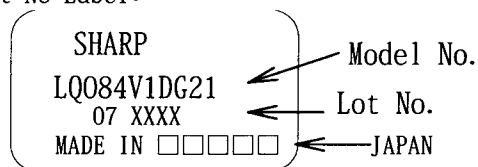

2) Adjusting volume have been set optimally before shipment, so do not change any adjusted value.

If adjusted value is changed, the specification may not be satisfied.

3) Disassembling the module can cause permanent damage and should be strictly avoided.

4) Please be careful since image retention may occur when a fixed pattern is displayed for a long time

5) Do not use LCD module in the atmosphere of corrosive gases, such as sulfide gas or chlorine gases.

Polarizer may deteriorated or cause chemical reaction that can lead to short circuits at the terminal Points. Do not use the material, which compounds contain sulfide or chlorine articles in the vicinity of LCD module. At high temperature, these compounds produce corrosive gases.

6) If any problem occurs in relation to the description of this specification , it shall be resolved through discussion with spirit of cooperation.

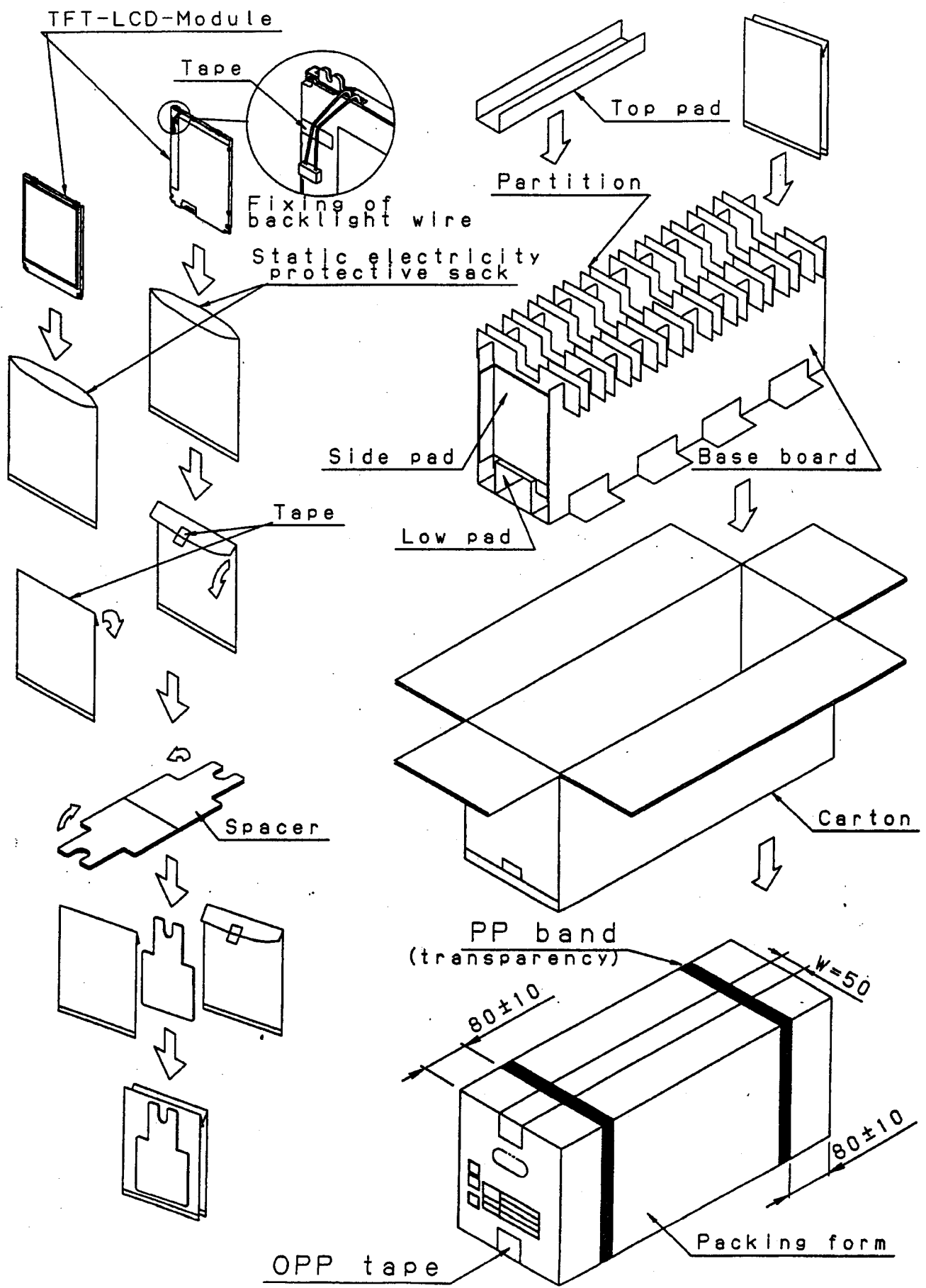

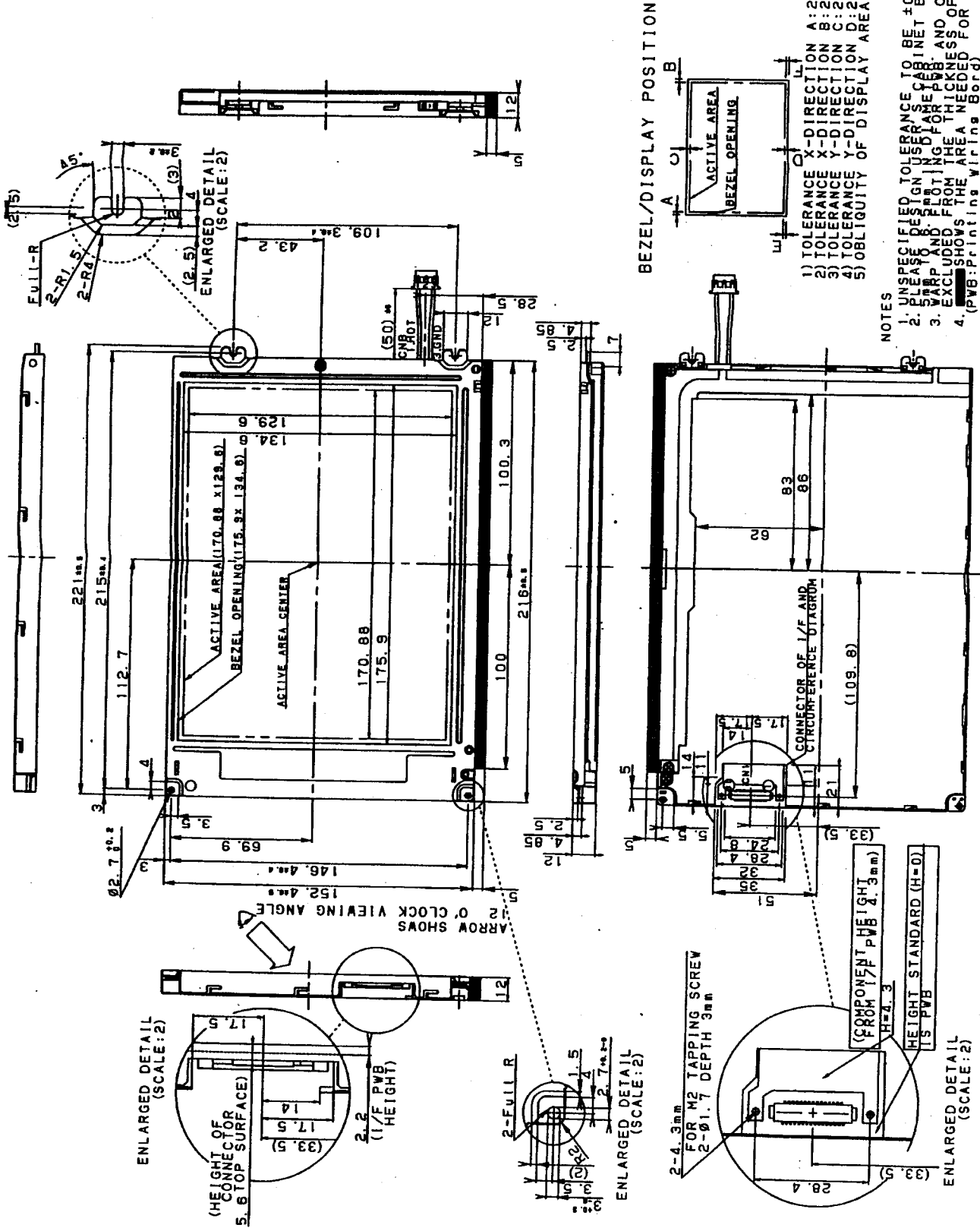

FIG. LQ084VIDG21 OUTLINE DIMENSIONS

SPECIFICATIONS ARE SUBJECT TO CHANGE WITHOUT NOTICE.

Suggested applications (if any) are for standard use; See Important Restrictions for limitations on special applications. See Limited Warranty for SHARP's product warranty. The Limited Warranty is in lieu, and exclusive of, all other warranties, express or implied. ALL EXPRESS AND IMPLIED WARRANTIES, INCLUDING THE WARRANTIES OF MERCHANTABILITY, FITNESS FOR USE AND FITNESS FOR A PARTICULAR PURPOSE, ARE SPECIFICALLY EXCLUDED. In no event will SHARP be liable, or in any way responsible, for any incidental or consequential economic or property damage.

SHARP®

NORTH AMERICA

SHARP Microelectronics of the Americas
5700 NW Pacific Rim Blvd.
Camas, WA 98607, U.S.A.
Phone: (1) 360-834-2500
Fax: (1) 360-834-8903
Fast Info: (1) 800-833-9437
www.sharpsma.com

EUROPE

SHARP Microelectronics Europe
Division of Sharp Electronics (Europe) GmbH
Sonninstrasse 3
20097 Hamburg, Germany
Phone: (49) 40-2376-2286
Fax: (49) 40-2376-2232
www.sharpsme.com

JAPAN

SHARP Corporation
Electronic Components & Devices
22-22 Nagaike-cho, Abeno-Ku
Osaka 545-8522, Japan
Phone: (81) 6-6621-1221
Fax: (81) 6117-725300/6117-725301
www.sharp-world.com

TAIWAN

SHARP Electronic Components
(Taiwan) Corporation
8F-A, No. 16, Sec. 4, Nanking E. Rd.
Taipei, Taiwan, Republic of China
Phone: (886) 2-2577-7341
Fax: (886) 2-2577-7326/2-2577-7328

SINGAPORE

SHARP Electronics (Singapore) PTE., Ltd.
438A, Alexandra Road, #05-01/02
Alexandra Technopark,
Singapore 119967
Phone: (65) 271-3566
Fax: (65) 271-3855

KOREA

SHARP Electronic Components
(Korea) Corporation
RM 501 Geosung B/D, 541
Dohwa-dong, Mapo-ku
Seoul 121-701, Korea
Phone: (82) 2-711-5813 ~ 8
Fax: (82) 2-711-5819

CHINA

SHARP Microelectronics of China
(Shanghai) Co., Ltd.
28 Xin Jin Qiao Road King Tower 16F
Pudong Shanghai, 201206 P.R. China
Phone: (86) 21-5854-7710/21-5834-6056
Fax: (86) 21-5854-4340/21-5834-6057

Head Office:

No. 360, Bashen Road,
Xin Development Bldg. 22
Waigaoqiao Free Trade Zone Shanghai
200131 P.R. China
Email: smc@china.global.sharp.co.jp

HONG KONG

SHARP-ROXY (Hong Kong) Ltd.
3rd Business Division,
17/F, Admiralty Centre, Tower 1
18 Harcourt Road, Hong Kong
Phone: (852) 28229311
Fax: (852) 28660779
www.sharp.com.hk

Shenzhen Representative Office:

Room 13B1, Tower C,
Electronics Science & Technology Building
Shen Nan Zhong Road
Shenzhen, P.R. China
Phone: (86) 755-3273731
Fax: (86) 755-3273735