

NPN Epitaxial Planar Transistor

BTC1510I3

Description

The BTC1510I3 is a NPN Darlington transistor, designed for general purpose amplifier and low speed switching application.

Features:

- High BV_{CEO}
- Low $V_{CE(SAT)}$
- High current gain
- Monolithic construction with built-in base-emitter shunt resistors
- Pb-free package

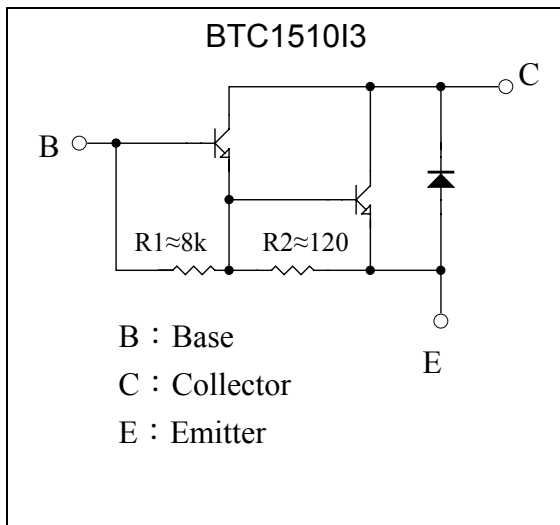
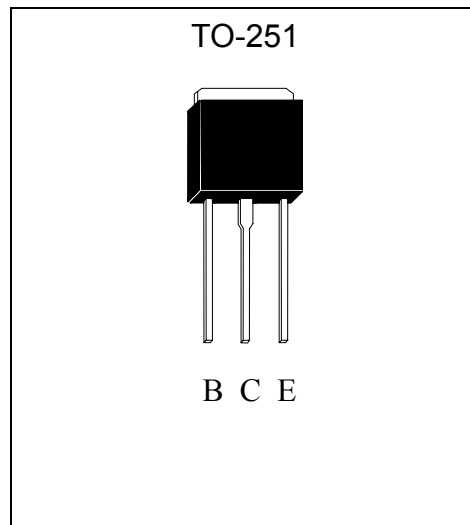
Equivalent Circuit**Outline**



Absolute Maximum Ratings (Ta=25°C)

Parameter	Symbol	Limits	Unit
Collector-Base Voltage	V _{CBO}	150	V
Collector-Emitter Voltage	V _{CEO}	150	V
Emitter-Base Voltage	V _{EBO}	5	V
Collector Current	I _C (DC)	10	A
	I _C (Pulse)	15 *1	
Power Dissipation	Pd(T _A =25°C)	1.75	W
	Pd(T _C =25°C)	20	
Junction Temperature	T _j	150	°C
Storage Temperature	T _{stg}	-55~+150	°C

Note : *1. Single Pulse Pw=100ms

Characteristics (Ta=25°C)

Symbol	Min.	Typ.	Max.	Unit	Test Conditions
BV _{CBO}	150	-	-	V	I _C =100μA, I _E =0
BV _{CEO}	150	-	-	V	I _C =1mA, I _B =0
I _{CEO}	-	-	200	μA	V _{CE} =150V, I _E =0
I _{CBO}	-	-	200	μA	V _{CB} =150V, I _E =0
I _{EBO}	-	-	2	mA	V _{EB} =5V, I _C =0
*V _{CE(sat) 1}	-	-	1.5	V	I _C =5A, I _B =10mA
*V _{CE(sat) 2}	-	-	3	V	I _C =10A, I _B =100mA
*V _{CE(sat) 3}	-	-	1.5	V	I _C =5A, I _B =2.5mA
*V _{BE(sat)}	-	-	2	V	I _C =5A, I _B =5mA
*V _{BE(on) 1}	-	-	2.8	V	V _{CE} =3V, I _C =5A
*V _{BE(on) 2}	-	-	4.5	V	V _{CE} =3V, I _C =10A
*V _{FEC}	-	-	3	V	I _C =5A
*h _{FE1}	2	-	20	K	V _{CE} =3V, I _C =5A
*h _{FE2}	100	-	-	-	V _{CE} =3V, I _C =10A

*Pulse Test : Pulse Width ≤380μs, Duty Cycle≤2%

Classification of V_{CE(sat) 1}

Rank	KA	N
Range	<1.1V	1.1~1.5V



Characteristic Curves

Current Gain vs Collector Current

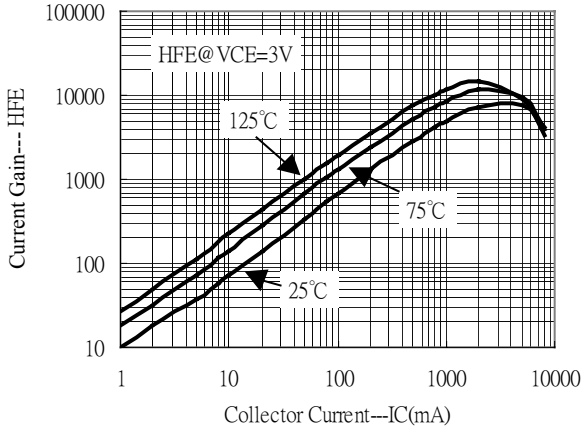

Saturation Voltage vs Collector Current

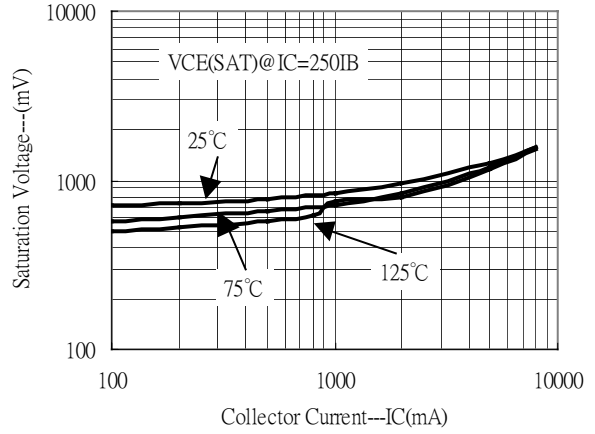

Saturation Voltage vs Collector Current

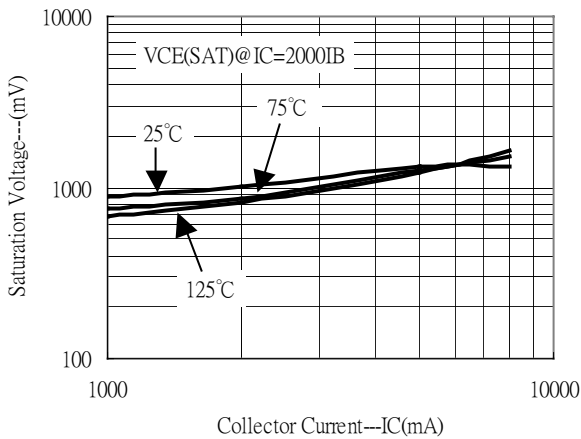

Saturation Voltage vs Collector Current

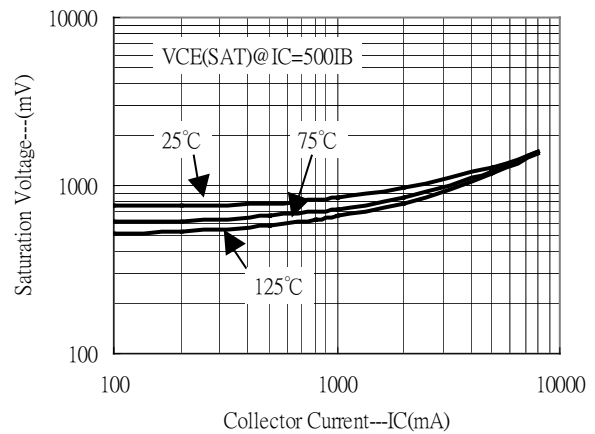

Saturation Voltage vs Collector Current

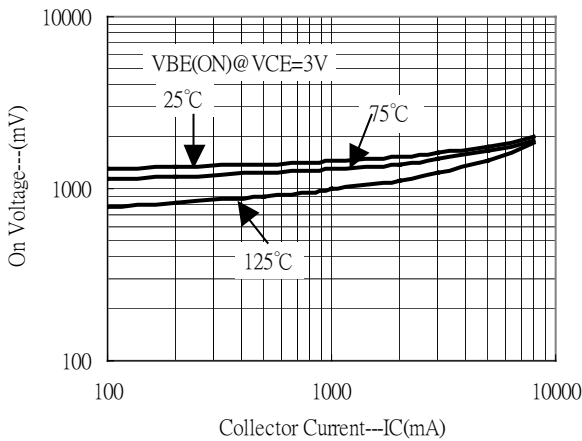

Power Derating Curve

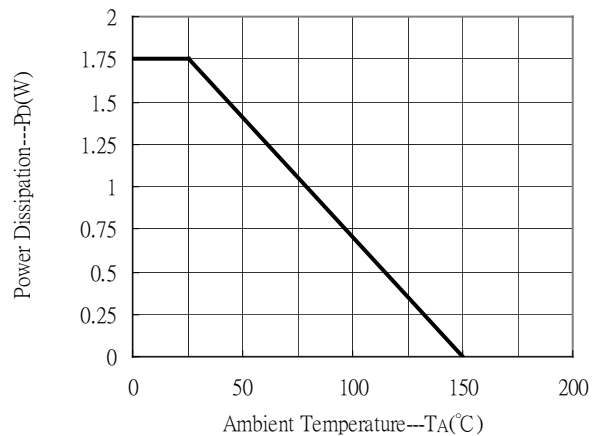



Power Derating Curve

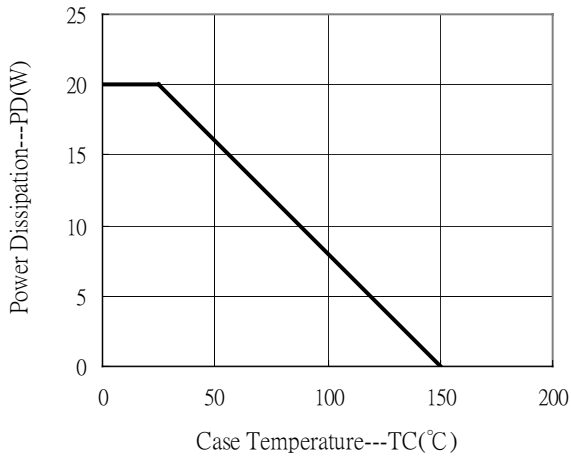

TO-251 Dimension

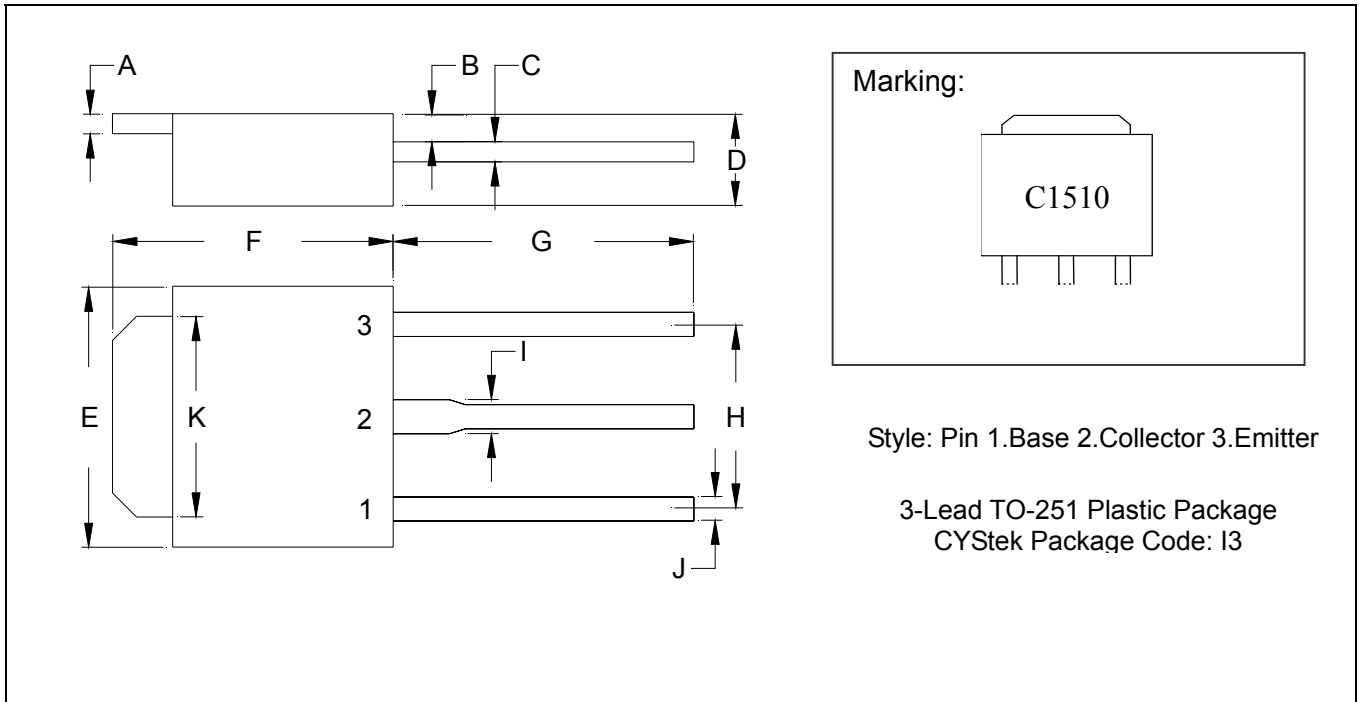

*: Typical

DIM	Inches		Millimeters		DIM	Inches		Millimeters	
	Min.	Max.	Min.	Max.		Min.	Max.	Min.	Max.
A	0.0177	0.0217	0.45	0.55	G	0.2559	-	6.50	-
B	0.0354	0.0591	0.90	1.50	H	-	*0.1811	-	*4.60
C	0.0177	0.0236	0.45	0.60	I	-	0.0354	-	0.90
D	0.0866	0.0945	2.20	2.40	J	-	0.0315	-	0.80
E	0.2520	0.2677	6.40	6.80	K	0.2047	0.2165	5.20	5.50
F	0.2677	0.2835	6.80	7.20					

Notes: 1.Controlling dimension: millimeters.
 2.Maximum lead thickness includes lead finish thickness, and minimum lead thickness is the minimum thickness of base material.
 3.If there is any question with packing specification or packing method, please contact your local CYStek sales office.

Material:

- Lead: 42 Alloy; solder plating
- Mold Compound: Epoxy resin family, flammability solid burning class: UL94V-0

Important Notice:

- All rights are reserved. Reproduction in whole or in part is prohibited without the prior written approval of CYStek.
- CYStek reserves the right to make changes to its products without notice.
- CYStek **semiconductor products are not warranted to be suitable for use in Life-Support Applications, or systems.**
- CYStek assumes no liability for any consequence of customer product design, infringement of patents, or application assistance.