



MOS DIGITAL INTEGRATED CIRCUIT

μ PD6105C-002

CMOS LSI FOR CHARACTER DISPLAY ON SCREEN

DESCRIPTION

The μ PD6105C-002 is a character display CMOS LSI used in combination with a microcomputer; it displays characters such as the time and channel number on a TV screen. If this LSI is used in a video camera or a VTR, the date, time, and so forth can be recorded overlapping the video signals. 5 X 7 dots format. The characters are made easy to see with the smoothing function for smoothing connection between dots and the background function for display on a black square background and black fringe.

FEATURES

- Number of display characters : 5 lines X 14 columns
- Character set : 64 (5 X 7 dots)
with smoothing function to join dots
- Cursor : Cursor indication is available for character display position corresponding to the write address
- Character color : Three colors may be specified line by line using commands. Colors may also be specified in the same line using color change data and color select data.
- Character size : Two character heights of 14 H, 28 H, 42 H, or 56 H may be specified for each line.
- Display position : 32 horizontal positions by 12/fosc (MHz), and 32 vertical positions by 9 H.
- Background : No background, square background, fringe, or solid background may be selected.
- Line space : Vertical line spacing may be set in 16 grades from 2 dots to 2 dots + 30 H.
- Control input : Display control and display data control are possible using 8 bit serial input data. (Three input terminals for data, clock, and strobe)
- Display output : Three character data output terminals (R, G, and B), and a blank output terminal.
- Display on/off : All display data may be set on or off, or it may be set line by line using commands. Some display data may also be set to off by display off data.
- Supply voltage : +5 V
- Package : 22 pin molded plastic DIP

3115

(2)

PD6105C 002

NEC ELECTRONIC DEVICE

ABSOLUTE MAXIMUM RATINGS (T_a=25 °C)

Supply Voltage	V _{DD} -V _{SS}	7	V
Input Voltage	V _{IN}	V _{SS} - 0.3 < V _{IN} < V _{DD} + 0.3	V
Output Voltage	V _{OUT}	V _{SS} - 0.3 < V _{OUT} < V _{DD} + 0.3	V
Operating Temperature	V _{opt}	-20 ~ +75	°C
Storage Temperature	V _{stg}	-40 ~ +125	°C
Power Dissipation	P _d	100	mW
Output Current	I _o	±5	mA

RECOMMENDED OPERATING CONDITIONS

CHARACTERISTIC	SYMBOL	MIN.	TYP.	MAX.	UNIT
Supply Voltage	V _{DD} -V _{SS}	4.5	5.0	5.5	V
Oscillation Frequency	f _{OSC}	4.5	5.0	5.5	MHz
Operating Temperature	T _{opt}	-10	+25	+60	°C
DATA, CLK, STB, CS High Level Input Voltage	V _{IH}	2.4			V
DATA, CLK, STB, CS Low Level Input Voltage	V _{IL}			0.8	V
V _{SYNC} High Level Input Voltage	V _{IH}	2.4			V
V _{SYNC} Low Level Input Voltage	V _{IL}			0.8	V
H _{SYNC} HOLD High Level Input Voltage	V _{IH}	4.5			V
H _{SYNC} HOLD Low Level Input Voltage	V _{IL}			1.0	V
V _{SYNC} Pulse Width	t _{VWL}	4			μs
H _{SYNC} Pulse Width	t _{HWL}	4			μs

ELECTRICAL CHARACTERISTICS

(T_a=25 °C, V_{DD}=5.0 V, V_{SS}=0 V, L_{osc}=56 μH, C_{osc IN}=5 ~ 30 pF, C_{osc OUT}=30 pF)

CHARACTERISTIC	SYMBOL	TEST CONDITION	MIN.	TYP.	MAX.	UNIT
Current Consumption	I _{DD}	C _{OSC IN} =20 pF		5	10	mA
High Level Output Voltage	V _{OH}	I _{OH} =-1 mA	4.5			V
Low Level Output Voltage	V _{OL}	I _{OL} =1 mA			0.5	V

3115 (3)

BLOCK DIAGRAM

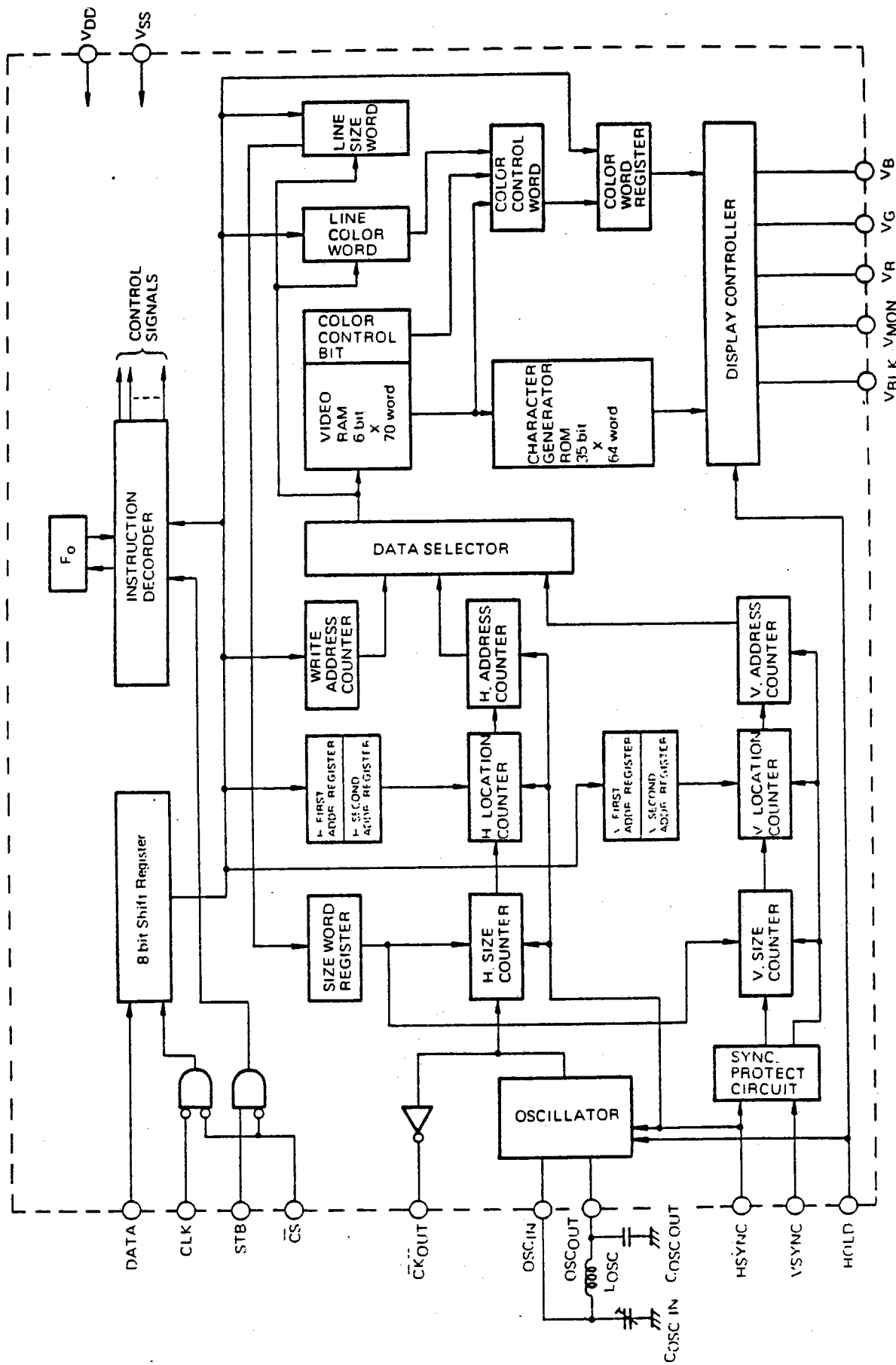

3115

(4)

CONNECTION DIAGRAM (Top View)

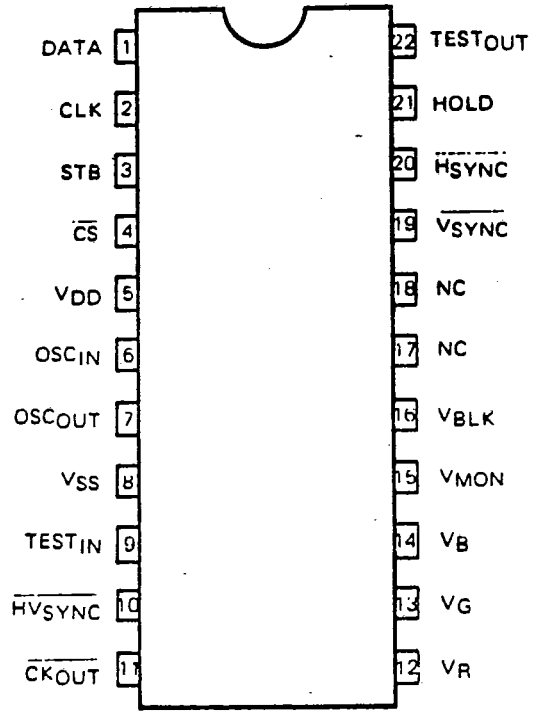

3115 (5)

PIN DESCRIPTION

SYMBOL	PIN NAME	FUNCTION
V _{DD}	Power supply terminal	Supplies +5.V.
V _{SS}	Ground terminal	Provides system grounding.
DATA	Serial data input terminal	Control data input terminal. Data is read in synchronization with clock signals sent to CLK terminal.
CLK	Clock input pin	Data read clock input pin. Data input to the DATA pin is read at the clock leading edge.
STB	Strobe input terminal	Terminal for strobe input after serial data input. Eight bit data is read on the leading edge of the pulse sent to STB terminal. If the 8 bit data is character data, the data address is increased on the trailing edge of the pulse.
\overline{CS}	Chip select terminal	Normal operation in low level; shift clock input (CLK) and strobe input (STB) input inhibited at the high level.
OSC IN OSC OUT	Oscillation terminal	Terminal that connects an oscillation capacitor and coil.
\overline{HSYNC}	Horizontal synchronization signal input terminal	Horizontal synchronization signal input terminal. Oscillated when \overline{HSYNC} is at the high level. Oscillation is synchronized with the change to high of \overline{HSYNC} . Operates during active low state.
\overline{VSYNC}	Vertical synchronization signal input terminal	Vertical synchronization signal input terminal. Operates during active high state.
V _R V _G V _B	Character signal output terminal	Character data output terminal that corresponds to R, G, or B. Output during active high state.
V _{BLK}	Blanking signal output terminal	Terminal for output of blanking signal that inhibits video signal. Output during active high state.
HOLD	Hold terminal	Stops oscillation during low state. At this time, output of V _R , V _G , V _B and V _{BLK} is low. (Normally, these states are set to high.)
V _{MON}	Character signal output monitor terminal	Output in high state, when R, G, or B character signal output is high.
\overline{CKOUT}	Clock out terminal	Inverse output of OSC OUT. If another $\mu PD6104$, $\mu PD6105$ is connected in parallel, the terminal should be connected to its OSC IN.
TEST _{IN}	TEST CLOCK input terminal	TEST CLOCK input terminal. (Normally, this should be connected to V _{SS} .)
\overline{HVSYNC}	V/H synchronization circuit switching terminal	In the low state, receives horizontal synchronization signals in synchronization with vertical synchronization signals. In the high state, receives horizontal synchronization signals as they are.
TEST _{OUT}	TEST output terminal	Output terminal for LSI TEST. Normally, this terminal is open.

3115 (6)

PD6105C 002

NEC ELECTRONIC DEVICE

DATA RAM MAP

Column	1	2	3	4	5	6	7	8	9	10	11	12	13	14	AR ₂	AR ₁	AR ₀	Line
AC ₃	0	0	0	0	0	0	0	0	1	1	1	1	1	1	0	0	0	1
AC ₂	0	0	0	0	1	1	1	1	0	0	0	0	1	1	0	0	0	1
AC ₁	0	0	1	1	0	0	1	1	0	0	1	1	0	0	0	0	0	1
AC ₀	0	1	0	1	0	1	0	1	0	1	0	1	0	0	1	0	0	1
SCR ₀ SW ₀ CCR ₀	CH ₀ CW ₀																	
SCR ₁ SW ₁ CCR ₁	CH ₁ CW ₁																	
SCR ₂ SW ₂ CCR ₂	CH ₂ CW ₂																	
SCR ₃ SW ₃ CCR ₃	CH ₃ CW ₃																	
SCR ₄ SW ₄ CCR ₄	CH ₄ CW ₄																	

6 bit X 70 word

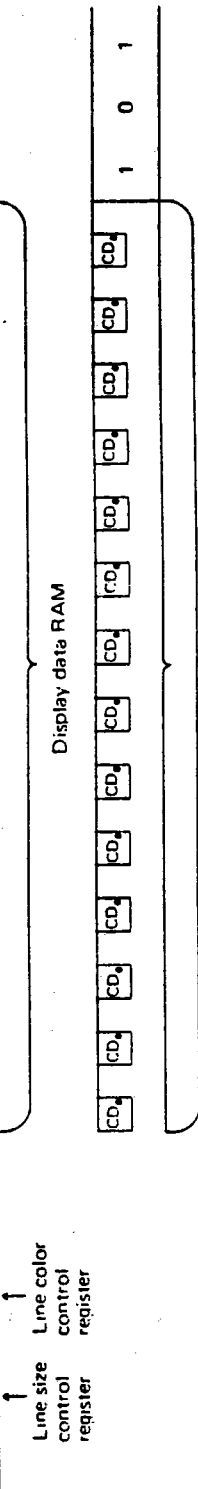

Color select RAM

Color word address	CW ₀	CW ₁	CW ₂	CW ₃	CW ₄	CW ₅	CW ₆	CW ₇	CW ₈	CW ₉	CW ₁₀	CW ₁₁	CW ₁₂	CW ₁₃	CW ₁₄
	R	R	R	R	R	R	R	R	R	R	R	R	R	R	R
	G	G	G	G	G	G	G	G	G	G	G	G	G	G	G
	B	B	B	B	B	B	B	B	B	B	B	B	B	B	B

Blank or display off

Color word 0 1 2

Size word address

SW ₀	0	1
S ₁	S ₁	S ₁
S ₀	S ₀	S ₀

Size word 0 1

CCR (Current color word) control register

CW ₀	CW ₁
-----------------	-----------------

3115 (17)

TYPE OF CHARACTERS

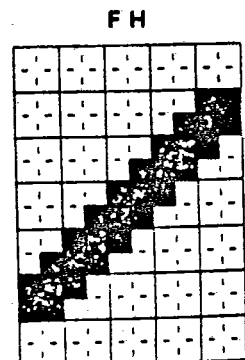
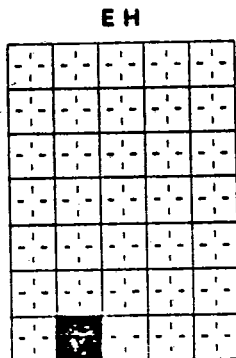
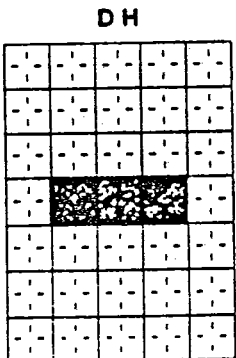
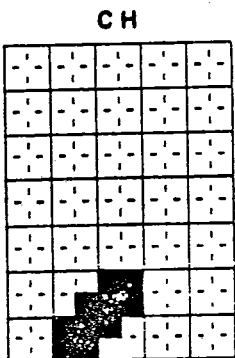
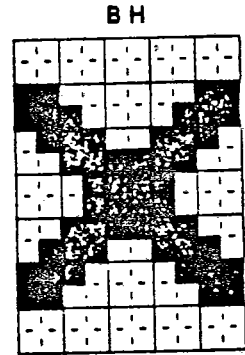
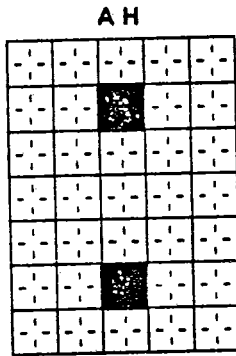
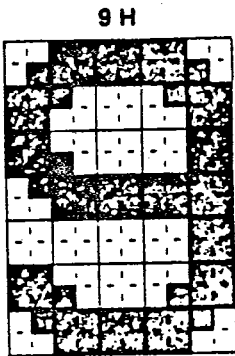
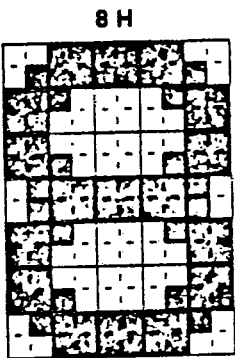
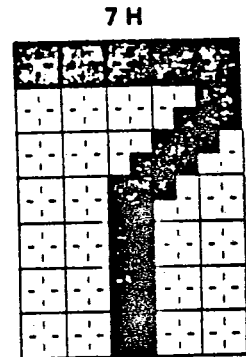
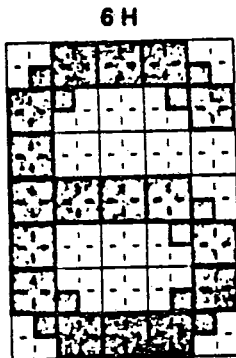
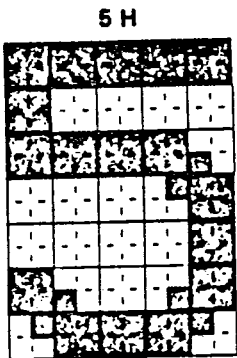
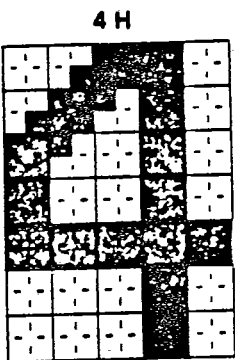
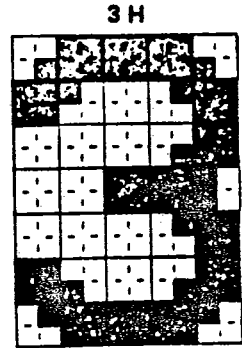
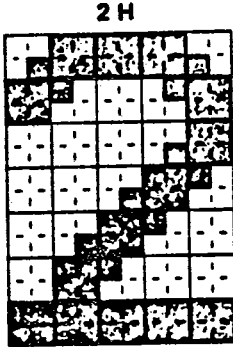
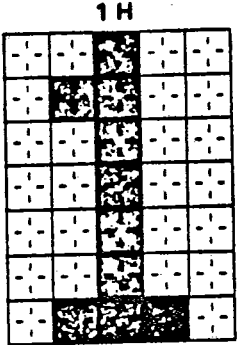
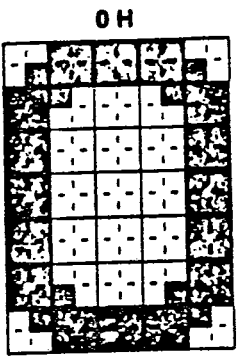

10 H

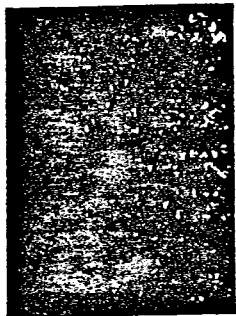

11 H

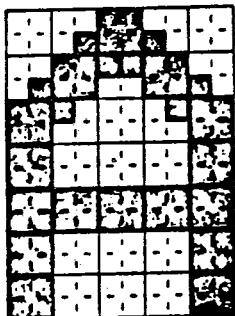

12 H

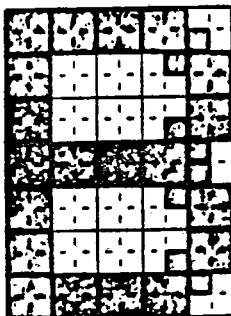

13 H

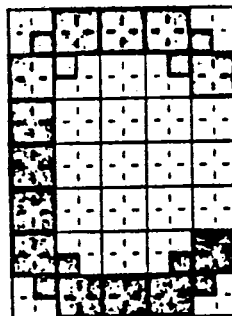

14 H

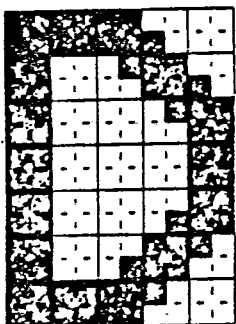

15 H

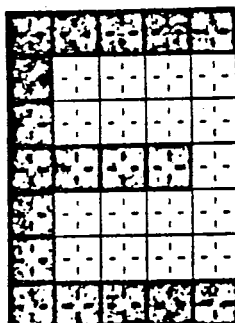

16 H

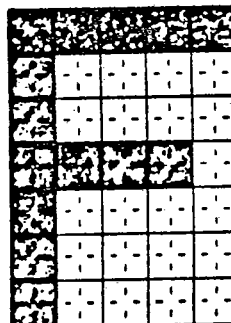

17 H

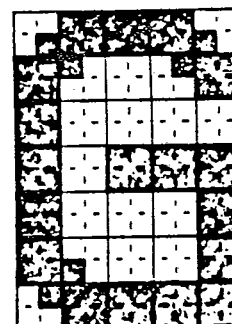

18 H

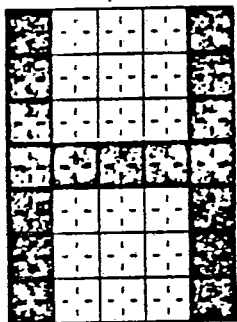

19 H

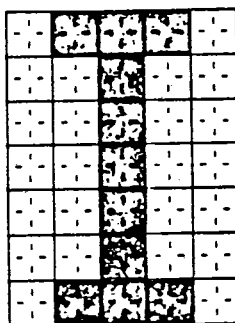

1 AH

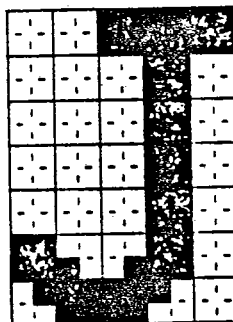

1 BH



1 CH

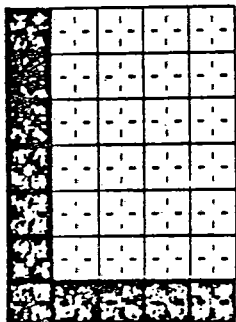

1 DH



1 EH



1 FH

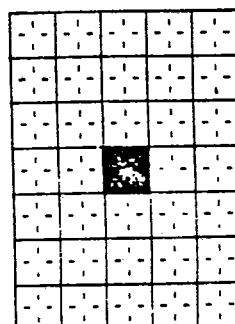

20 H

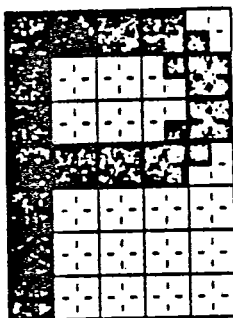

21 H

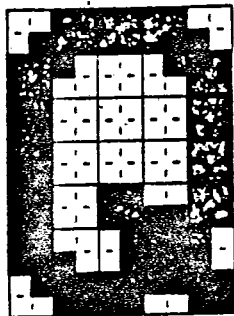

22 H

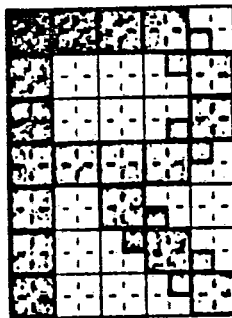

23 H

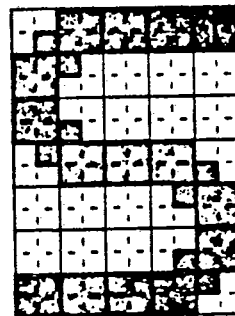

24 H

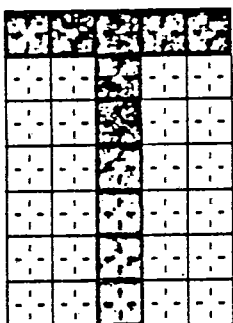

25 H

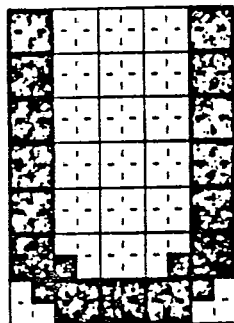

26 H

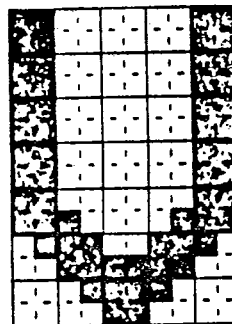

27 H

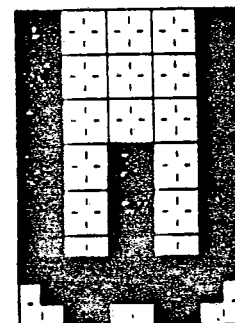

28 H

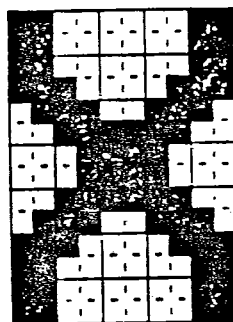

29 H

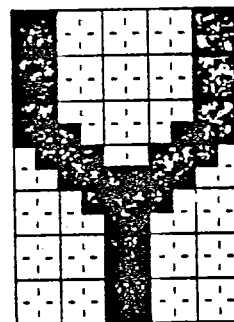

2 AH

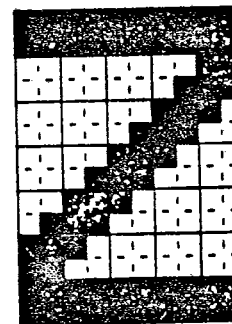

2 BH

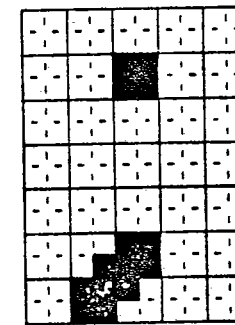

2 CH

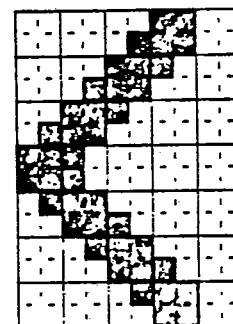

2 DH

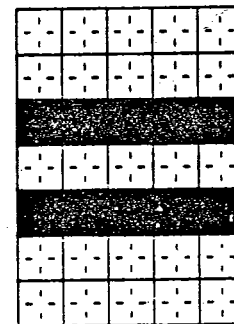

2 EH

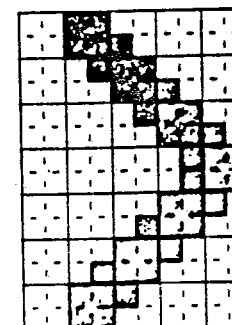

2 FH



3115

(10)

PD6105C-002

NEC

30 H



31 H

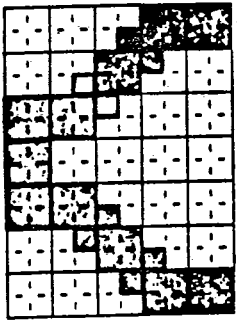

32 H

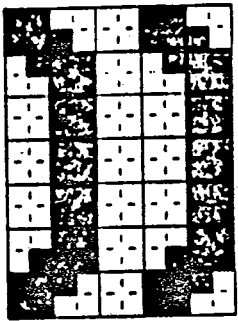

33 H

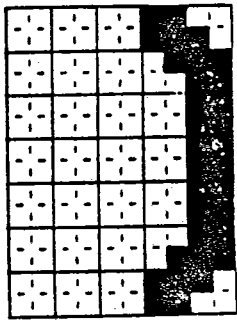

34 H

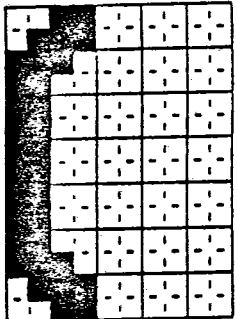

35 H

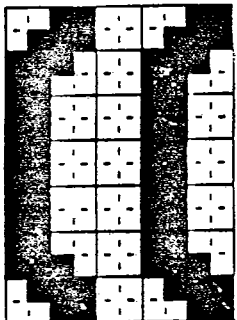

36 H

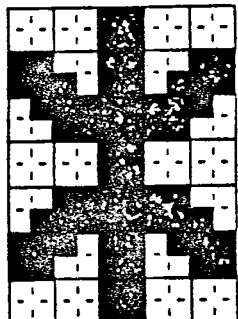

37 H

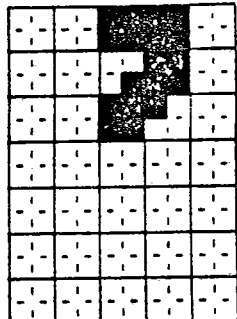

38 H

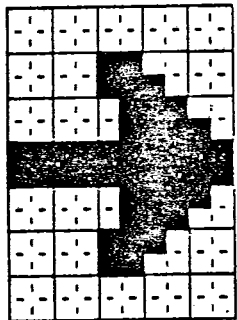

39 H

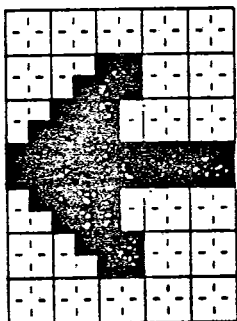

3 AH

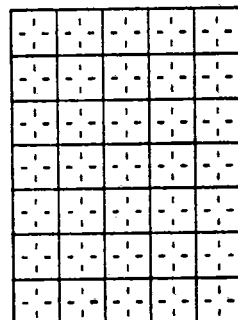

(Blank)

3 BH

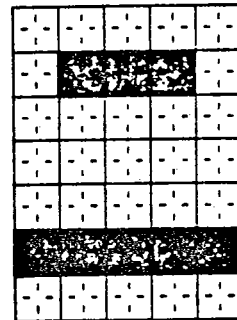

3 CH

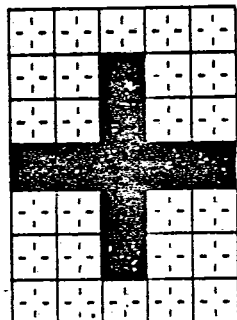

3 DH

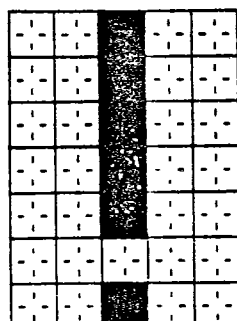

3 EH

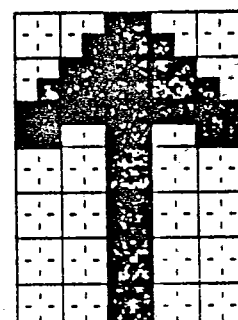

3 FH

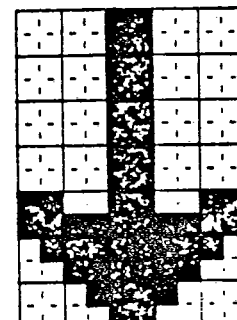

3115

11



$(CH_5, CH_4, CH_3, CH_2, CH_1, CH_0) = (1, 1, 1, 0, 1, 0) \dots \dots$ Blank

In the case of square background :

$(CH_5, CH_4, CH_3, CH_2, CH_1, CH_0) = (1, 1, 1, 0, 1, 1) \dots \dots$ Display OFF data

When $FS_1 (D_1)$ of the function select command is 0 :

$(CH_5, CH_4, CH_3, CH_2, CH_1, CH_0) = (1, 1, 1, 1, 0, 0),$

$(1, 1, 1, 1, 0, 1),$

$(1, 1, 1, 1, 1, 0) \dots \dots$ Color data

$(CH_5, CH_4, CH_3, CH_2, CH_1, CH_0) = (1, 1, 1, 1, 1, 1) \dots \dots$ OFF data in line

LIST OF μPD6105C COMMANDS

BANK	F ₀	D ₇	D ₆	D ₅	D ₄	D ₃	D ₂	D ₁	D ₀	CONTENT
0	0	0	0	CH ₅	CH ₄	CH ₃	CH ₂	CH ₁	CH ₀	Character data
	0	0	1	0	0	AC ₃	AC ₂	AC ₁	AC ₀	Write column address
	0	0	1	1	0	CF ₀	AR ₂	AR ₁	AR ₀	Write line address
	0	0	1	1	1	X	X	X	X	TEST
	0	1	0	CW ₁	CW ₀	0	R	G	B	Color word specification
	0	1	0	X	SW ₀	1	X	S ₁	S ₀	Size word specification
	0	1	1	0	0	BS ₁	BS ₀	CW ₁	CW ₀	Background specification
	0	1	1	0	1	0	DO ₀	X	X	Display ON/OFF
	0	1	1	0	1	1	CO ₀	X	X	Cursor ON/OFF*
	0	1	1	1	0	FS ₃	FS ₂	FS ₁	FS ₀	Function select*
	X	1	1	1	1	1	1	F ₀	F _R	Format specification
1	1	0	0	0	H ₄	H ₃	H ₂	H ₁	H ₀	First horizontal start address setting
	1	0	0	1	H ₄	H ₃	H ₂	H ₁	H ₀	Second horizontal start address setting*
	1	0	1	0	V ₄	V ₃	V ₂	V ₁	V ₀	First vertical start address setting
	1	0	1	1	V ₄	V ₃	V ₂	V ₁	V ₀	Second vertical start address setting*
	1	1	0	CW ₁	CW ₀	0	AR ₂	AR ₁	AR ₀	Line color specification*
	1	1	1	0	SW ₀	X	AR ₂	AR ₁	AR ₀	Line size specification*
	1	1	1	1	0	RS ₃	RS ₂	RS ₁	RS ₀	Vertical line spacing*

X : Don't care

* : The command is reset by resetting the format

3115 (12)

INDEX

- 1. CHARACTER DISPLAY**
- 2. FORMAT SPECIFICATION**
- 3. FORMAT RESET**
- 4. DATA WRITING**
- 5. CHARACTER SIZE**
 - 5.1 Writing of size word register (SWR)
 - 5.2 Writing in the size control register (SCR)
- 6. CHARACTER COLOR**
 - 6.1 Specifying one color for each line
 - 6.2 Specifying different colors in the same line using color change data
 - 6.3 Specifying different colors in the same line using color selection data
- 7. BACKGROUND SPECIFICATION**
- 8. CURSOR INDICATION**
- 9. DISPLAY POSITION**
 - 9.1 Displaying five lines or fourteen columns without division
 - 9.2 Displaying the second and third lines with no division
- 10. DISPLAY ON/OFF CONTROL**
 - 10.1 Entire display ON/OFF
 - 10.2 Line display OFF/Blank
 - 10.3 Display OFF/Blank in one line
 - 10.4 Character display OFF/Blank
- 11. SMOOTHING FUNCTION**

1. CHARACTER DISPLAY

Seventy characters are displayed in 5 lines X 14 columns as shown below.

				Column address													
AR ₂ AR ₁ AR ₀	AC ₃	0	0	0	0	0	0	0	0	1	1	1	1	1	1		
	AC ₂	0	0	0	0	1	1	1	1	0	0	0	0	1	1		
	AC ₁	0	0	1	1	0	0	1	1	0	0	1	1	0	0		
	AC ₀	0	1	0	1	0	1	0	1	0	1	0	1	0	1		
0	0	0	<input type="checkbox"/>	<input type="checkbox"/>	<input type="checkbox"/>	<input type="checkbox"/>	<input type="checkbox"/>	<input type="checkbox"/>	<input type="checkbox"/>	<input type="checkbox"/>	<input type="checkbox"/>	<input type="checkbox"/>	<input type="checkbox"/>	<input type="checkbox"/>	<input type="checkbox"/>		
0	0	1	<input type="checkbox"/>	<input type="checkbox"/>	<input type="checkbox"/>	<input type="checkbox"/>	<input type="checkbox"/>	<input type="checkbox"/>	<input type="checkbox"/>	<input type="checkbox"/>	<input type="checkbox"/>	<input type="checkbox"/>	<input type="checkbox"/>	<input type="checkbox"/>	<input type="checkbox"/>		
0	1	0	<input type="checkbox"/>	<input type="checkbox"/>	<input type="checkbox"/>	<input type="checkbox"/>	<input type="checkbox"/>	<input type="checkbox"/>	<input type="checkbox"/>	<input type="checkbox"/>	<input type="checkbox"/>	<input type="checkbox"/>	<input type="checkbox"/>	<input type="checkbox"/>	<input type="checkbox"/>		
0	1	1	<input type="checkbox"/>	<input type="checkbox"/>	<input type="checkbox"/>	<input type="checkbox"/>	<input type="checkbox"/>	<input type="checkbox"/>	<input type="checkbox"/>	<input type="checkbox"/>	<input type="checkbox"/>	<input type="checkbox"/>	<input type="checkbox"/>	<input type="checkbox"/>	<input type="checkbox"/>		
1	0	0	<input type="checkbox"/>	<input type="checkbox"/>	<input type="checkbox"/>	<input type="checkbox"/>	<input type="checkbox"/>	<input type="checkbox"/>	<input type="checkbox"/>	<input type="checkbox"/>	<input type="checkbox"/>	<input type="checkbox"/>	<input type="checkbox"/>	<input type="checkbox"/>	<input type="checkbox"/>		

The space between characters is one dot, and the space between lines can be specified in 16 grades by 2 H (from 2 dots to 2 dots +30 H) using the line spacing command.

Line Spacing Command

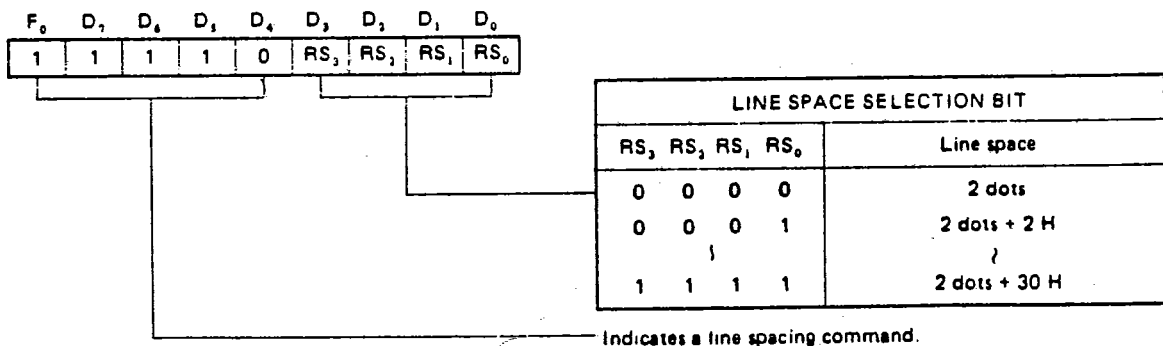

Line spacing does not depend on character size. After format resetting, the command is set for (RS₃, RS₂, RS₁, RS₀)=(0,0,0,0). (line space: 2 dots)

3115 (14)

PD6105C-002

NEC ELECTRONICS

2. FORMAT SPECIFICATIONS

Each μ PD6105 command consists of nine bits, and the shift register for the external serial interface consists of eight bits. There are two types of commands—display format specification mode commands, and normal mode commands. Switching of command type is performed using bit 1 (F_0) of the format specification command.

Normal mode command ($F_0=0$)

- Character data
- Write column address
- Write line address
- Word color specification
- Word size specification
- Background specification
- Display ON/OFF
- Cursor ON/OFF
- Function selection

Display format specification commands ($F_0=1$)

- Horizontal No. 1 start address setting
- Horizontal No. 2 start address setting
- Vertical No. 1 start address setting
- Vertical No. 2 start address setting
- Line color specification
- Line size specification
- Vertical line spacing

3115

(15)

3. FORMAT RESET ($F_R=1$)

Specify bit (F_R) of the format specification command to clear the test command mode and reset the contents of the next command. Format resetting is not latched.

- (1) Set the contents of line color control register ($CCR_{0\text{ to }4}$) to $(CW_1, CW_0)=(0,0)$.
- (2) Set the contents of line size control register ($SCR_{0\text{ to }4}$) to $(SW_0)=(0)$.
- (3) Set the contents of the vertical spacing selection bit to $(RS_3, RS_2, RS_1, RS_0)=(0,0,0,0)$.
(Line space is 2 dots.)
- (4) Set horizontal No. 2 start address to $(H_4, H_3, H_2, H_1, H_0)=(1,1,1,1,1)$.
(Divided horizontal OFF display.)
- (5) Set vertical No. 2 start address to $(V_4, V_3, V_2, V_1, V_0)=(1,1,1,1,1)$.
(Divided vertical OFF display.)
- (6) Set the contents of the function selection command to $(FS_3, FS_2, FS_1, FS_0)=(1,0,0,0)$.
 - Smoothing feature
 - Division OFF for second to third lines
 - Color specification possible in one line using color change data
 - Blank selection by a display control command
- (7) Set the cursor control bit to $(CO_0)=(0)$.
(The cursor is set to off.)
- (8) Set (color flag bit) of the write line address command to $(CF_0)=(0)$.
(The color change function by color select data is cleared.)

Format Specification Command

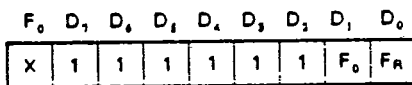

FORMAT RESET BIT (not latched)	
F_R	Function
1	The test mode is cleared and the command is reset.

BANK SWITCHING BIT	
F_0	Function
0	All normal mode commands can be used.
1	All display format specification mode commands can be used

Indicates a format specification command.

3115 (16)

4. DATA WRITING

A data write address can be placed in the address counter using a write line address setting command and a write column address setting command.

If data is written by means of a character data command after specifying the address, the address is automatically increased.

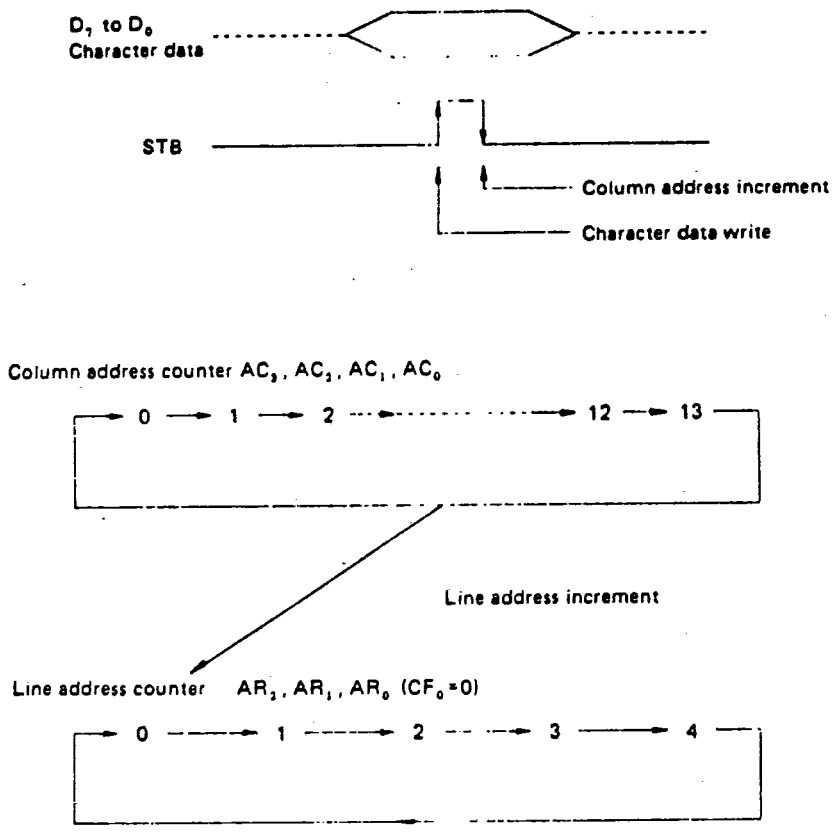

If the function to change colors in one line using color selection data* is set on (CF₀=1), the line address counter uses base 6 notation, and the line address (AR₂, AR₁, AR₀)=(1,0,1) stores color select data.

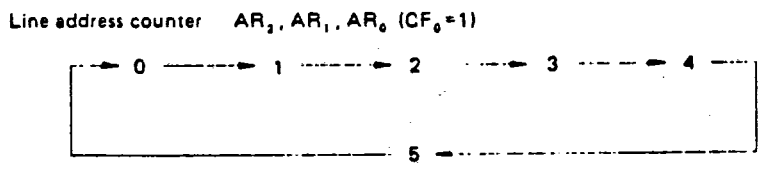

* For details, see the section explaining color specification in one line using color select data.

Write Line Address Setting Command

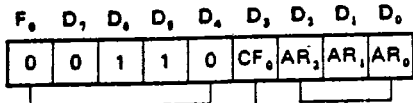

LINE ADDRESS SPECIFICATION BIT			
AR ₂ AR ₁ AR ₀			Function
0	0	0	Specifies first line.
0	0	1	Specifies second line.
		↓	↓
1	0	0	Specifies fifth line.
1	0	1	Specifies sixth line.* (Writing color select data)

Addresses 0 to 5 may be set.

COLOR FLAG BIT*	
CF ₀	Function
0	Clears function of changing color using color select data.
1	Performs function of color changing using color select data.

* See section explaining color specification in one line using color select data.

Indicates a write line address setting command.

Write Column Address Setting Command

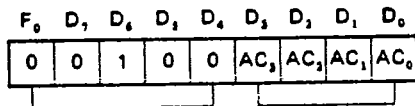

COLUMN ADDRESS SPECIFICATION BIT				
AC ₃ AC ₂ AC ₁ AC ₀				Function
0	0	0	0	Specifies first column.
0	0	0	1	Specifies second column.
		↓	↓	↓
1	1	0	1	Specifies 14th column.

Addresses 0 to D may be set.

Indicates a write column address setting command.

311.5

18

5. CHARACTER SIZE

A character size can be specified for each line. It is possible to store any two 14 H, 28 H, 42 H, or 56 H character heights in the two bit size word register. Each line has a single-bit line size control register. The character size of a line corresponds to the size stored in the size word register (SWR), and may be specified by the SWR that corresponds to the line.

5.1 WRITING OF SIZE WORD REGISTER (SWR)

The following size word setting command is used to store the character size in the size word register.

Size Word Setting Command

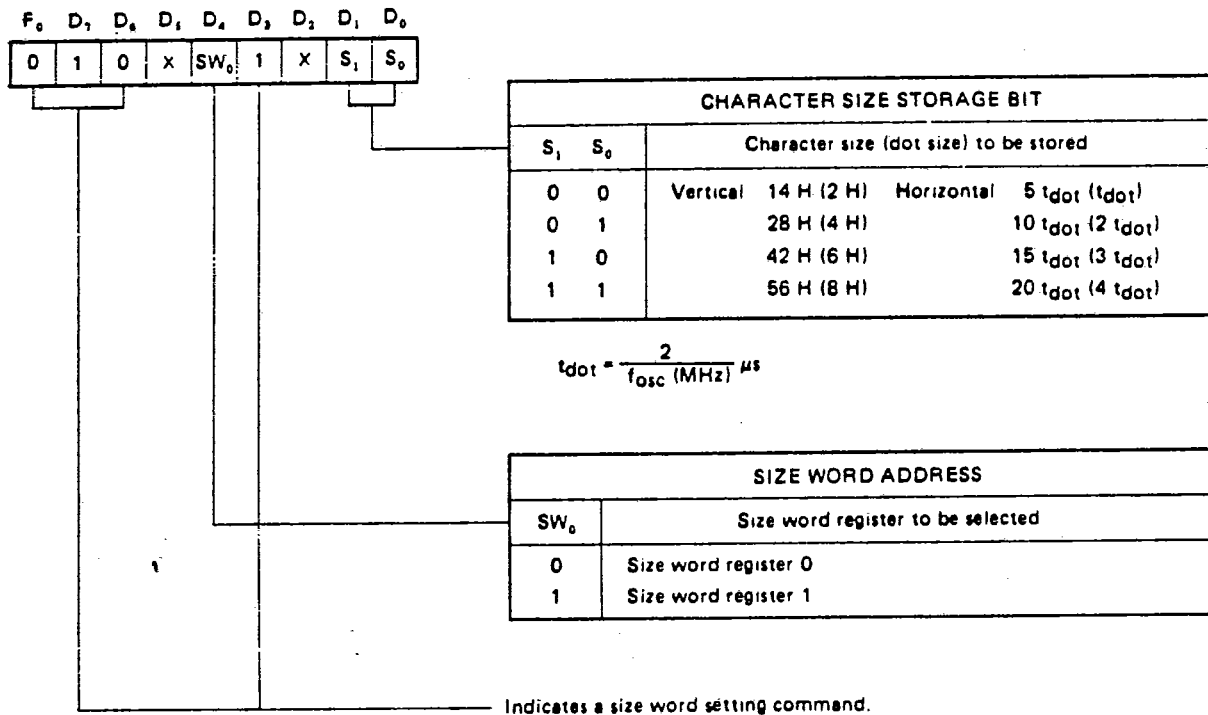

5.2 WRITING IN THE SIZE CONTROL REGISTER (SCR)

The line size specification command stores the size word address (SW_0) of the size word register (SWR) that stores a character size in line size control register ($SCR_{0\text{ to }4}$) corresponding to a line.

Line Size Specification Command

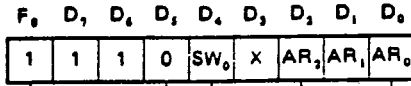

LINE ADDRESS SELECTION BIT			
AR_2	AR_1	AR_0	Line address to be selected
0	0	0	Specifies first line.
0	0	1	Specifies second line.
		↓	↓
1	0	0	Specifies fifth line.

Addresses 0 to 4 may be set.

SIZE WORD ADDRESS	
SW_0	Size word register to be specified
0	Size word register 0
1	Size word register 1

Indicates a line size specification command.

After the format is reset, the contents of register ($SCR_{0\text{ to }4}$) for each line is set to (SW_0)=(0).

Example

Display the first, third, and fourth line characters with character height 14 H, and the second and fifth line characters with character height 28 H.

PD6105C-002

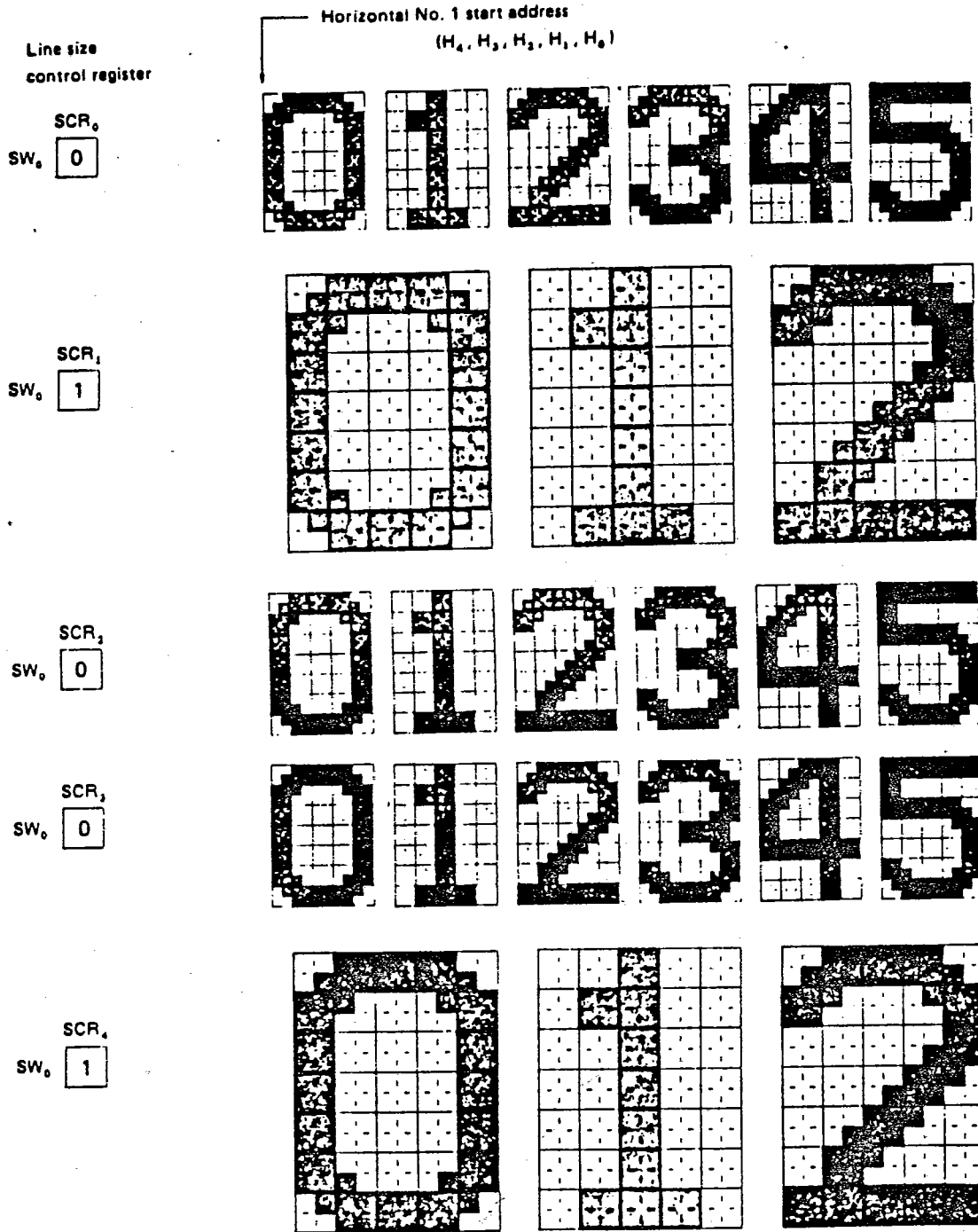

Size word register

	SWR ₀	SWR ₁
Size specification bit S ₁	0	0
Size specification bit S ₀	0	1
Size word address SW ₀	0	1

3115 (21)

6. CHARACTER COLOR

The color of a character may be one of three kinds depending on which color word registers (CWR), bit R, G, or B, is specified.

The color word register (CWR) can specify three of the following colors: red, blue, green, yellow, purple, light blue, white or black. Specification is made using the color word setting command.

Color Word Setting Command

F₀ D₇ D₆ D₅ D₄ D₃ D₂ D₁ D₀



CHARACTER COLOR DATA BIT			
R	G	B	Character color
0	0	0	Black
0	0	1	Blue
0	1	0	Green
0	1	1	Light blue
1	0	0	Red
1	0	1	Purple
1	1	0	Yellow
1	1	1	White

COLOR WORD ADDRESS		
CW ₁	CW ₀	Color word register to be selected
0	0	Color word register 0
0	1	Color word register 1
1	0	Color word register 2
1	1	Blank or display off*

* See the section explaining line display OFF/Blank.

Indicates a color word setting command.

Character color specification

The characters color can be specified in the following three ways:

- Specifying one color for each line
- Specifying different colors in the same line using color change data
- Specifying different colors in the same line using color selection data

PD6105C-002

6.1 SPECIFYING ONE COLOR FOR EACH LINE

Each line has a two-bit line color control register (CCR_{0 to 4}). The character color of a line corresponds to the color stored in the color word register (CWR) and is specified by the contents (CW₁, CW₀).

Writing in color control register (CCR_{0 to 4})

The line color specification command stores the color word address (CW₁, CW₀) of the color word register (CWR) that stores the color of the characters in the line color control register (CCR_{0 to 4}) corresponding to the line.

Line Color Specifying Command

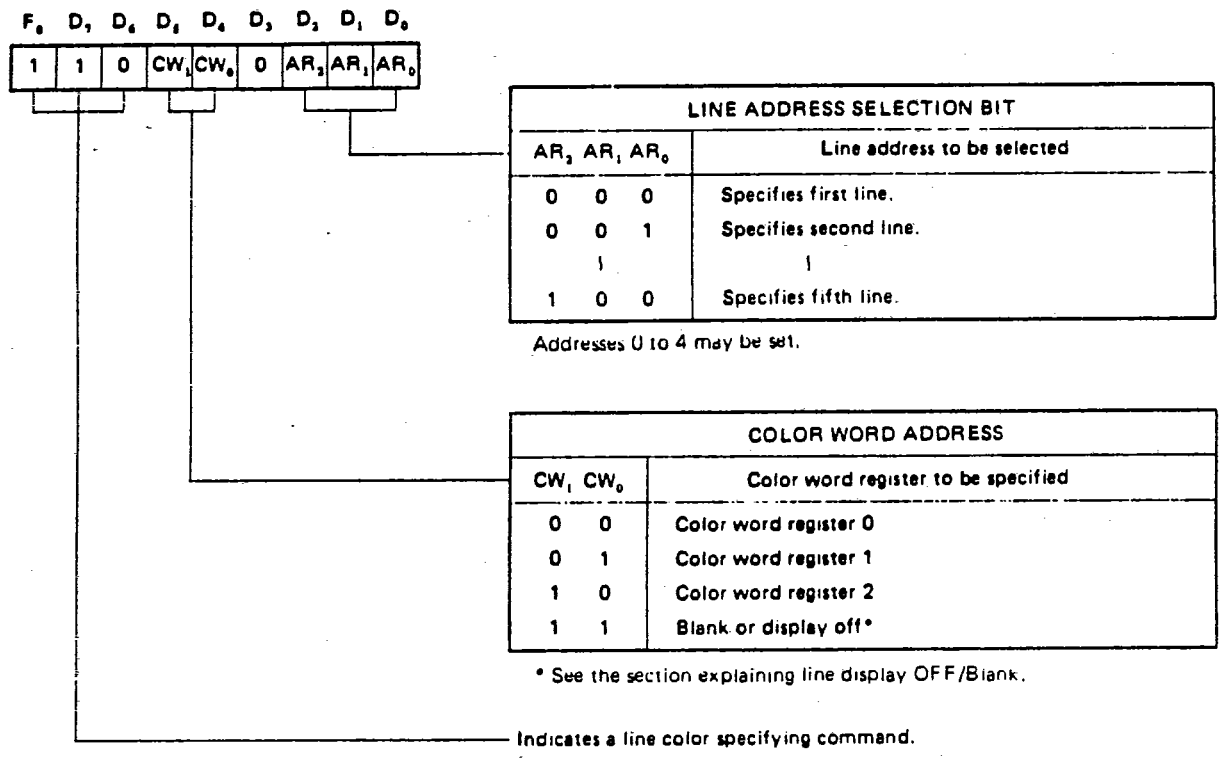

After format reset, the contents of the line color control register (CCR_{0 to 4}) for each line is set to (CW₁, CW₀) = (0,0).

Example

When displaying blue characters in the nth line.

3115 (23)

CCR
Current color
control register
(Shows currently
specified color
word.)

Column 1 2 3 4 5 6 7 8 9 10 11 12 13 14

CW ₁	0	0	0	0	0	0	0	0	0	0	0	0	0	0
CW ₀	1	1	1	1	1	1	1	1	1	1	1	1	1	1

RAM data

Character data

Display

Characters (blue)

Nth line color
control register

CCR_n

CW ₁	0
CW ₀	1

Color word register

CW₀ CW₁ CW₂

Color specification bit	R	1	0	0
	G	Red 0	Blue 0	Green 1
	B	0	1	0
Color word address	CW ₁	0	0	1
	CW ₀	0	1	0

6.2 SPECIFYING DIFFERENT COLORS IN THE SAME LINE USING COLOR CHANGE DATA

It is possible to specify different colors in the same line using the following data in the character data command:

- (CH₅, CH₄, CH₃, CH₂, CH₁, CH₀)=(1,1,1,1,0,0): Color change data 1
[Change the color to the color of the color word address (CW₁, CW₀)=(0,0).]
- (CH₅, CH₄, CH₃, CH₂, CH₁, CH₀)=(1,1,1,1,0,1): Color change data 2
[Change the color to the color of the color word address (CW₁, CW₀)=(0,1).]
- (CH₅, CH₄, CH₃, CH₂, CH₁, CH₀)=(1,1,1,1,1,0): Color change data 3
[Change the color to the color of the color word address (CW₁, CW₀)=(1,0).]

If any color change data is found when scanning a data RAM, it is possible to change the contents of the current color control register (CCR) to the color word address specified by the lower two bits (CH₁, CH₀) of the color change data from the address of the data RAM to the end of the line independent of the content of the line color control register (CCR_{0 to 4}). The address that specifies the color change data becomes blank or is put in the display off* status (specified by the first bit (FS₀) of the function selection command).

Color change data can be used an arbitrary number of times for the same line. It can be switched to character data with the FS₁ bit of a FUNCTION SELECT command.

* For an explanation of the difference between blank and DISPLAY OFF, see the section Line Display OFF/Blank.

Character Data Command

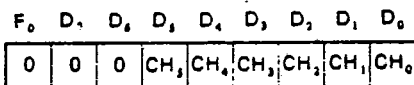

CHARACTER DATA BIT							
CH ₅	CH ₄	CH ₃	CH ₂	CH ₁	CH ₀	Display data	
0	0	0	0	0	0	Character data, 58 kinds	
1	1	1	0	0	1		
1	1	1	0	1	0	Blank	
1	1	1	0	1	1	Display OFF/character data ¹⁾	
1	1	1	1	0	0	Character data	
1	1	1	1	0	1		Color change data 1 Change to the color of (CW ₁ , CW ₀)=(0,0)
1	1	1	1	1	0		Color change data 2 Change to the color of (CW ₁ , CW ₀)=(0,1)
1	1	1	1	1	0	Color change data 3 Change to the color of (CW ₁ , CW ₀)=(1,0)	
1	1	1	1	1	1	OFF data in the line/character data ²⁾	

1) See the section explaining the display OFF/Blank for each character.
2) See the section explaining the display OFF/Blank in one line

Indicates a character data command.

3115 (25)

Function Selection Code

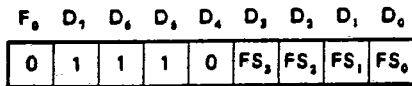

BLANK/OFF SELECTION BIT	
FS ₀	Function
0	The address that specifies the color change data becomes blank. The line having the register contents (CW ₁ , CW ₀)=(1,1), and the portion from the address in which the OFF data in the line, is written to the end of the line, and is put in the display OFF status.
1	The address that specifies the color change data is put in the display OFF status. The line having register contents (CW ₁ , CW ₀)=(1,1), and the section from the address in which the OFF data in the line is written, to the end of the line is put in the display OFF status.

DATA SWITCHING BIT	
FS ₁	Function
0	(CH ₃ , CH ₂ , CH ₁ , CH ₀)=(1,1,1,1,0,0), (1,1,1,1,0,1), (1,1,1,1,1,0) is color changing data, and (CH ₃ , CH ₂ , CH ₁ , CH ₀)=(1,1,1,1,1,1) is Off data* for the line.
1	(CH ₃ , CH ₂ , CH ₁ , CH ₀)=(1,1,1,1,0,0) ~ (1,1,1,1,1,1) is character data.

* See the section explaining display ON/OFF control.

Lines 2 to 3 division on/off switching bit
(See the section explaining the display position.)

Smoothing function on/off bit
(See the section explaining the smoothing function.)

Indicates a function selection command.

After format resetting, FS₁=0 (color changing data and OFF data in the line are available*), and FS₀=0 (blank selection) are set.

* See the section explaining display ON/OFF control.

3115

RG

7-96101-002

NEC

Example

Changing the character color of the nth line from blue to green and red in one line.

CCR
Current color
control register
(Shows the currently
specified color word.)

Column	1	2	3	4	5	6	7	8	9	10	11	12	13	14
CW ₁	0	0	0	0	1	1	1	1	0	0	0	0	0	0
CW ₀	1	1	1	1	0	0	0	0	0	0	0	0	0	0

RAM data

Character data	Color con- trol data	Character data	Color con- trol data	Character data
----------------	-------------------------	----------------	-------------------------	----------------

(CH₃, CH₂, CH₁, CH₀, CH₃, CH₂, CH₁, CH₀)
=(1,1,1,1,1,0)

(CH₃, CH₂, CH₁, CH₀, CH₃, CH₂, CH₁, CH₀)
=(1,1,1,1,0,0)

Display

Character (blue)	Blank or display off	Character (green)	Blank or display off	Character (red)
---------------------	-------------------------	----------------------	-------------------------	--------------------

Nth line color
control register

CCR_n

CW ₁	0
CW ₀	1

Color word register

	CWR ₀	CWR ₁	CWR ₂
R	1	0	0
G	Red 0	Blue 0	Green 1
B	0	1	0
CW ₁	0	0	1
CW ₀	0	1	0

Color
specification
bit

Color word
address

3115

(27)

6.3 SPECIFYING DIFFERENT COLORS IN ONE LINE USING COLOR SELECTION DATA

Colors in one line can be changed using one-bit color selection data written in line address (AR_2, AR_1, AR_0) = (1,0,1).

The display data RAMs are scanned sequentially from line addresses (AR_2, AR_1, AR_0) = (0,0,0) to (AR_2, AR_1, AR_0) = (1,0,0). Each time the display data RAM of a line is scanned, the color selection data RAM of line address (AR_2, AR_1, AR_0) = (1,0,1) is scanned.

If the contents of the current color control register is (CW_1, CW_0) = (0,0), the RGB output is changed to the color of color word (CW_1, CW_0) = (0,1), for the column of the color selection data which is 1.

The color selection data uses the LSB (lowest digit) of the data to be written in each column of line address (AR_2, AR_1, AR_0) = (1,0,1). Writing is performed in the same way as character data. This function can be set ON/OFF using bit 1 of the write line address setting command.

Write Line Address Setting Command

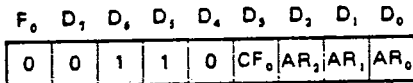

LINE ADDRESS SELECTION BIT			
AR_2	AR_1	AR_0	Function
0	0	0	Specifies lines 1 to 5. Character data is written here.
1	0	0	
1	0	1	Specifies line 6. One-bit color selection data is written here.

COLOR FLAG BIT	
CF_0	Function
0	Color selection data can be written, even if the color selection data is "1". No color change operation, however, is performed.
1	Detects color selection data. A logical one changes the color.

Indicates a write line address setting command.

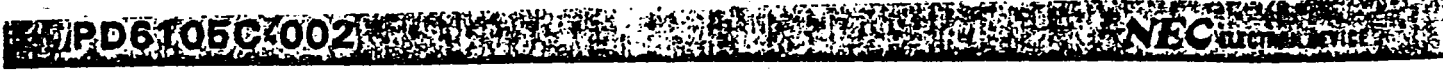

Example

Alternately displays red and blue characters.

Color selection data RAM	CD ₀	0	1	1	0	0	0	1	1	0	1	0	1	1	1
--------------------------	-----------------	---	---	---	---	---	---	---	---	---	---	---	---	---	---

CCR Current color control register (Indicates currently specified color word.)	CW ₁	1	1	1	0	0	0	0	0	0	0	0	0	0	0
	CW ₀	0	0	0	0	0	0	0	0	0	0	0	0	0	0

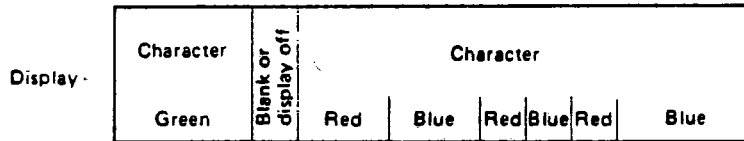
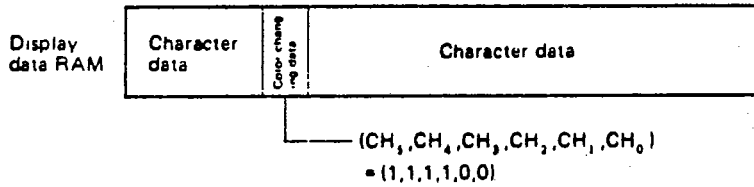

CCR _n		Color word register					
CW ₁	1	CWR ₀	CWR ₁	CWR ₂			
CW ₀	0	R	1	0	0		
Color specification bit	G	Red	0	Blue	0	Green	1
		B	0	1	0		
Color word address	CW ₁	CW ₁	0	0	1		
		CW ₀	0	1	0		

3115

29



7. BACKGROUND SPECIFICATIONS

The type of background (no background, Fringe, Square background, solid background and its color (color stored in color word registers 0 to 2, or black) may be specified with the background specification command.

Background Specification Command

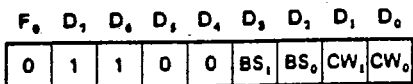

BACKGROUND COLOR SPECIFICATION BIT	
CW ₁ , CW ₀	Function
0 0	The background color becomes the color written in word register 0.
0 1	The background color becomes the color written in word register 1.
1 0	The background color becomes the color written in word register 2.
1 1	Background color is black.

BACKGROUND TYPE SPECIFICATION BIT	
BS ₁ , BS ₀	Function
0 0	No background
0 1	Fringe
1 0	Square background
1 1	Solid background

Indicates a background specification command.

In the case of no background, $\{(BS_1, BS_0)=(0,0)\}$ sets the color specification bit to $(CW_1, CW_0)=(1,1)$.



Background

Fringe

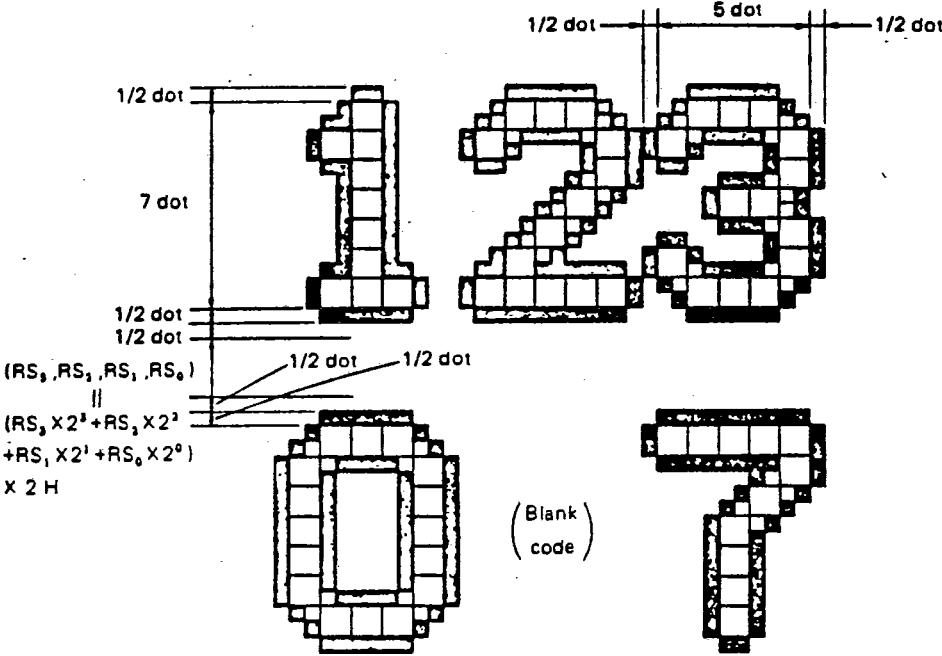

Square Background

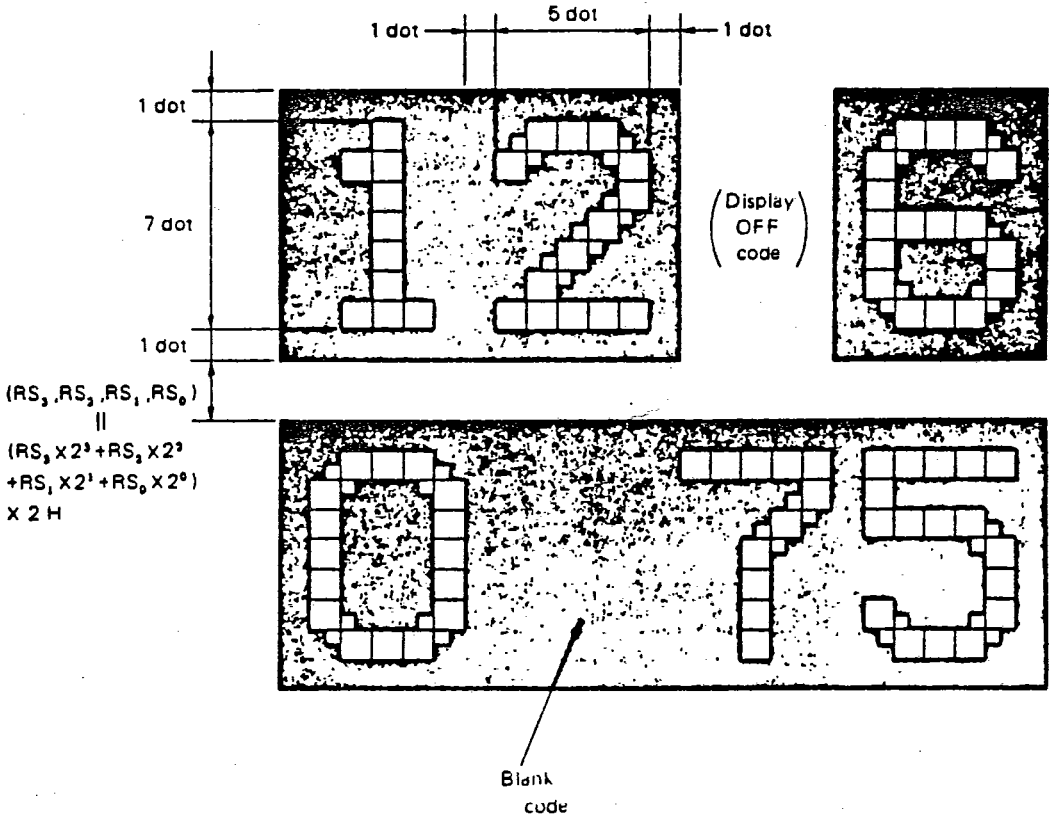

Solid Background

The solid background is same type as square background, and all video signals are changed to the background color.

3115 31

8. CURSOR INDICATION

With the μ PD6105C, a cursor indicates the address in which data is to be written. The cursor position is decided by the write address counter. Control the ON/OFF state of the cursor using the cursor control command.

Cursor Control Command

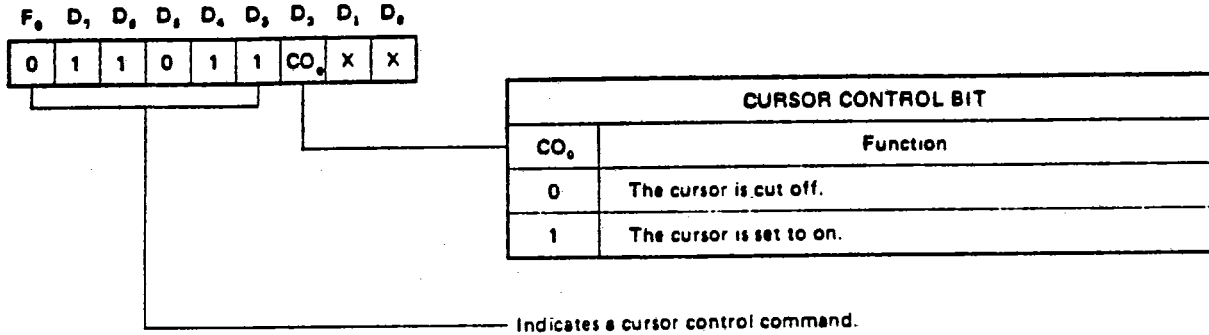

When the display of a line is set to OFF from the beginning of the line, or in the line with line display OFF data, the cursor does not appear even if the writing address is set in the portion where the display is cut OFF. The cursor can be set to ON if the display is cut OFF by Display OFF or blank data.

After format resetting, CO₀=0 is set (cursor is cut OFF).

3115

32

STD6105C-002

NEC ELECTRONIC DEVICE

CURSOR

No Background

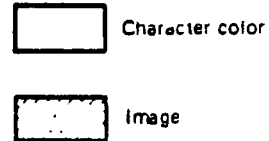
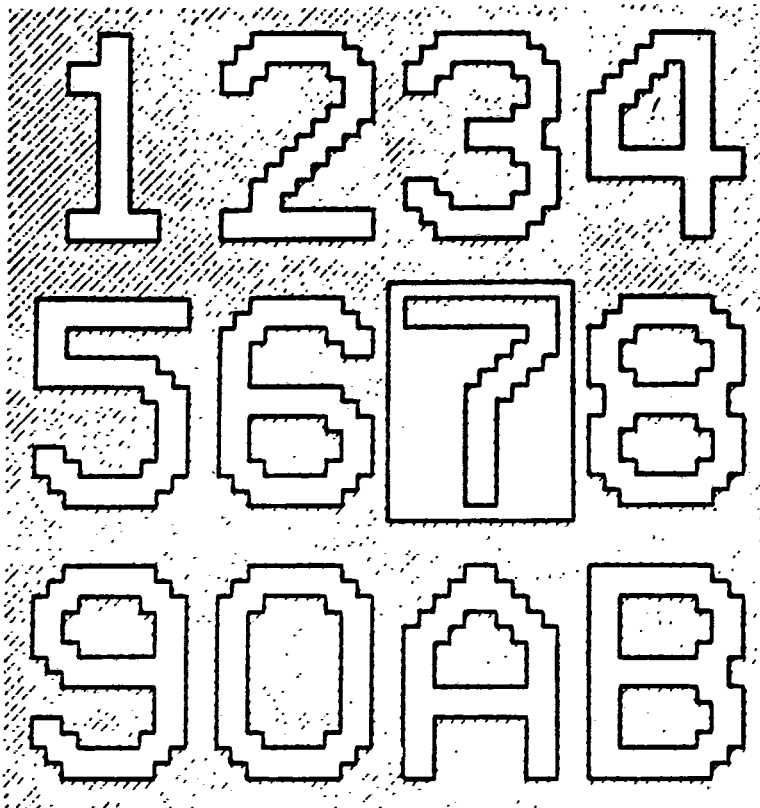

Fringe

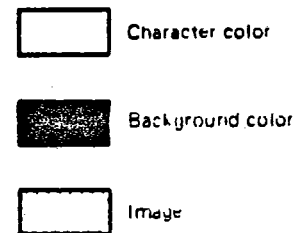



PD6105C-002

Square Background/Solid Background



Character color
Background color



9. DISPLAY POSITION

A character can be displayed in 32 horizontal positions [$12/f_{osc}(\text{MHz})\mu\text{s}$] for the minimum character size (character height is 14 H), and in 32 vertical positions, each half the minimum character size (9 H). The display can be divided into six and eight characters, and two or more lines by specifying the appropriate addresses with the horizontal first and second start address setting commands, and vertical first and second start address setting commands. The second start address must not set specify an address that overlaps display characters starting in the first start address.

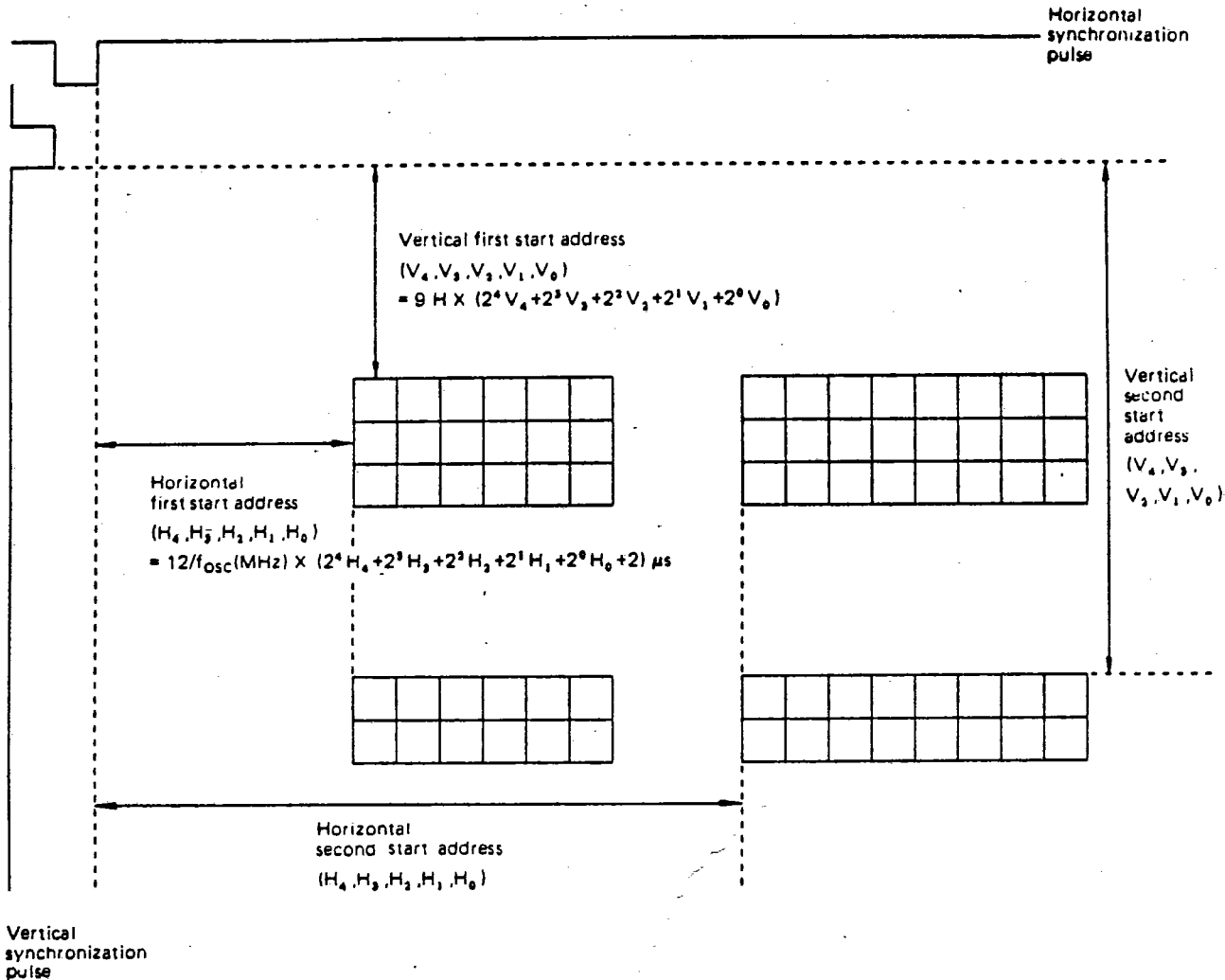

9.1 DISPLAYING FIVE LINES OR 14 CHARACTERS WITHOUT DIVISION

If (1,1,1,1,1) is set in both the horizontal and vertical second start addresses, display is made with five vertical lines or 14 horizontal characters undivided. If, for example, $(H_4, H_3, H_2, H_1, H_0) = (1,1,1,1,1)$ is set in the horizontal second start address, 14 characters are displayed horizontal without division. In the same manner, if $(V_4, V_3, V_2, V_1, V_0) = (1,1,1,1,1)$ is set in the vertical second start address, five lines are displayed without division.

Example

$(H_4, H_3, H_2, H_1, H_0) = (1,1,1,1,1)$ and

$(V_4, V_3, V_2, V_1, V_0) = (1,1,1,1,1)$ are set in the horizontal and vertical second start addresses.

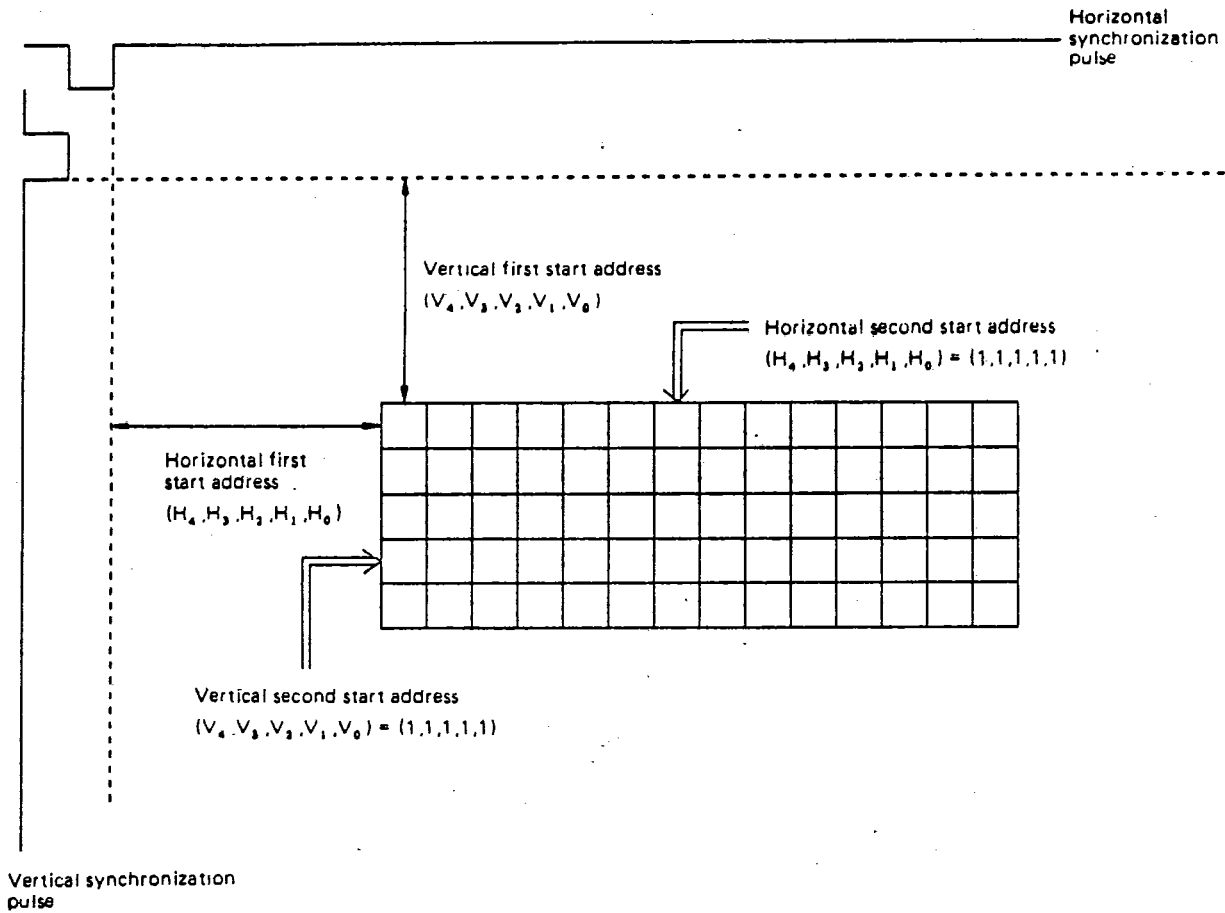

PD6105C-002

NEC ELECTRONICS

Horizontal First Start Address Setting Command

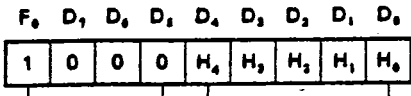

HORIZONTAL START ADDRESS SPECIFICATION BIT					Start address
H ₄	H ₃	H ₂	H ₁	H ₀	
0	0	0	0	0	After the horizontal synchronization pulse 12/f _{osc} (MHz) X 3 (μs)
0	0	0	0	1	After the horizontal synchronization pulse 12/f _{osc} (MHz) X 4 (μs)
1	1	1	1	1	After the horizontal synchronization pulse 12/f _{osc} (MHz) X 33 (μs)

Indicates a horizontal first start address setting command.

Horizontal Second Start Address Setting Command

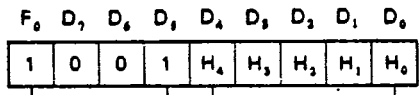

HORIZONTAL START ADDRESS SPECIFICATION BIT					Start address
H ₄	H ₃	H ₂	H ₁	H ₀	
0	0	1	1	1	After the horizontal synchronization pulse 12/f _{osc} (MHz) X 9 (μs)
0	1	0	0	0	After the horizontal synchronization pulse 12/f _{osc} (MHz) X 10 (μs)
1	1	1	1	0	After the horizontal synchronization pulse 12/f _{osc} (MHz) X 32 (μs)
1	1	1	1	1	Fourteen characters are displayed horizontally without division

The second start address must not specify an address that overlaps the display part (six characters) starting from the first start address. No address can be set if the (second start address) - (first start address) is less than 6.

Indicates a horizontal second start address setting command.



Vertical First Start Address Setting Command

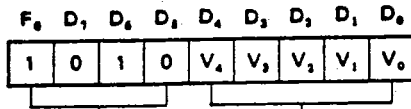

VERTICAL START ADDRESS BIT					Start address
V ₄	V ₃	V ₂	V ₁	V ₀	
0	0	0	0	0	After the vertical synchronization pulse 9 X 0 H
0	0	0	0	1	After the vertical synchronization pulse 9 X 1 H
1	1	1	1	1	After the vertical synchronization pulse 9 X 31 H

Indicates a vertical first start address setting command.

Vertical Second Start Address Setting Command

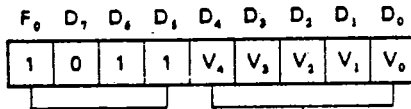

VERTICAL START ADDRESS BIT					Start address
V ₄	V ₃	V ₂	V ₁	V ₀	
0	0	1	1	1	After the vertical synchronization pulse 9 X 7 H
0	1	0	0	0	After the vertical synchronization pulse 9 X 8 H
1	1	1	1	0	After the vertical synchronization pulse 9 X 30 H
1	1	1	1	1	Five lines are displayed without division.

The second start address must not set an address that overlaps the display part (three lines) starting from the first start address.

Indicates a vertical second start address setting command.

3115

(38)

2115

(20)

PD6105C-002

NEC ELECTRONICS

9.2 DISPLAYING THE SECOND AND THIRD LINES WITH NO DIVISION

Horizontal and vertical display is divided into four parts with the horizontal and vertical second start addresses. Use bit 1 (FS_2) of the function selection command to specify if the second and third lines are to be divided or not (independent of other lines).

Function Selection Command

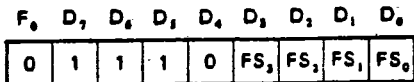

Blank/OFF selection bit
(See section explaining Display ON/OFF Control.)

Color change data / Character data change bit
Line display OFF data /
(Specifies color in one line using color changing data.
See section explaining display OFF/Blank in one line.)

DIVISION ON/OFF SWITCHING BIT FOR SECOND AND THIRD LINES	
FS_2	FUNCTION
0	Horizontal division OFF for second and third lines.
1	Horizontal division ON for second and third lines.

Smoothing function ON/OFF bit
(See section explaining the smoothing function.)

Indicates a function selection commands.

After format resetting, $FS_2=0$ is set. (Division OFF for second and third lines.)

39

Example

Division OFF ($FS_2=0$) for second and third lines

$(H_4, H_3, H_2, H_1, H_0) = (1, 1, 1, 1, 1)$

$(V_4, V_3, V_2, V_1, V_0) = (1, 1, 1, 1, 1)$

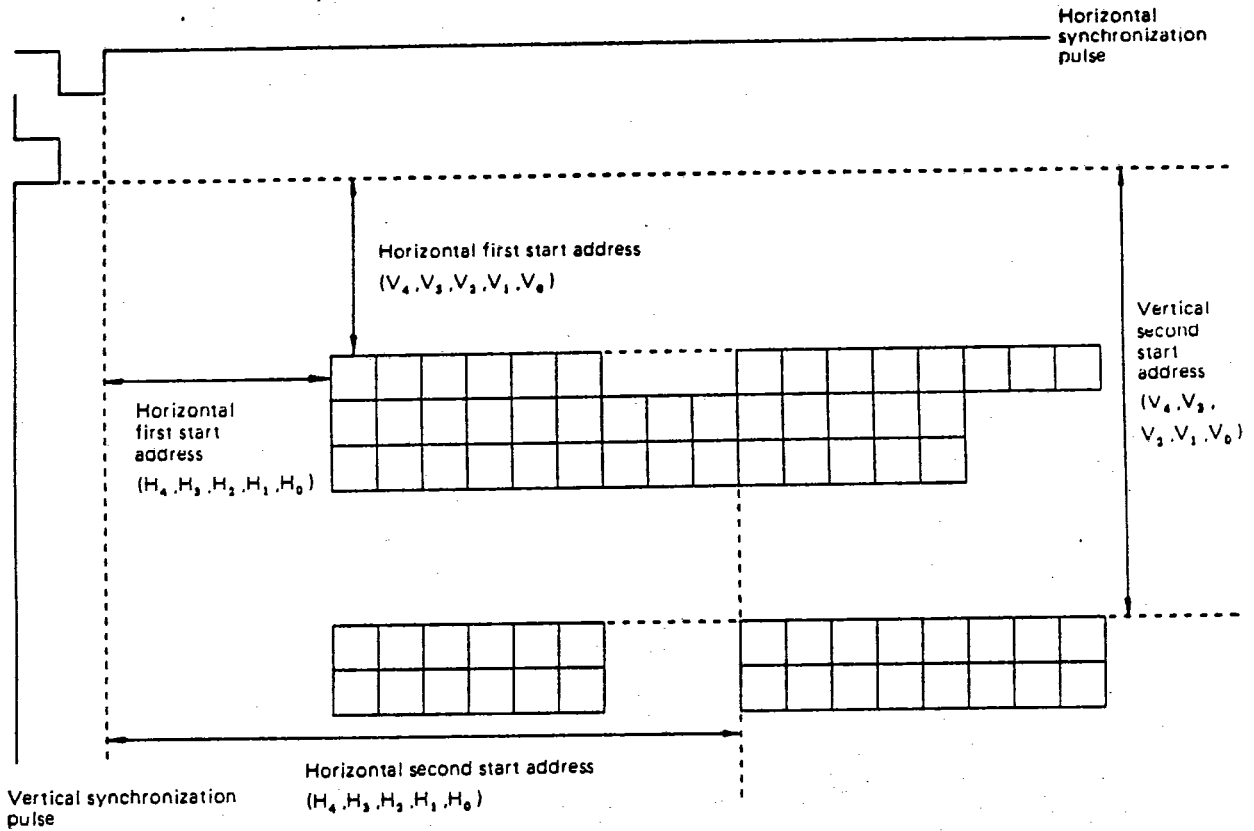

FD6T05C 002

NEC ELECTRONICS

10. DISPLAY ON/OFF CONTROL

There are four method of controlling display as follows:

- o Entire display ON/OFF
- o Line display OFF/Blank
- o Display OFF/Blank in one line
- o Character display OFF/Blank

10.1 ENTIRE DISPLAY ON/OFF

Use the display ON/OFF command to display all characters on the screen or erase them. Even when the display is in the off state, it is possible to write characters.

Display ON/OFF Command

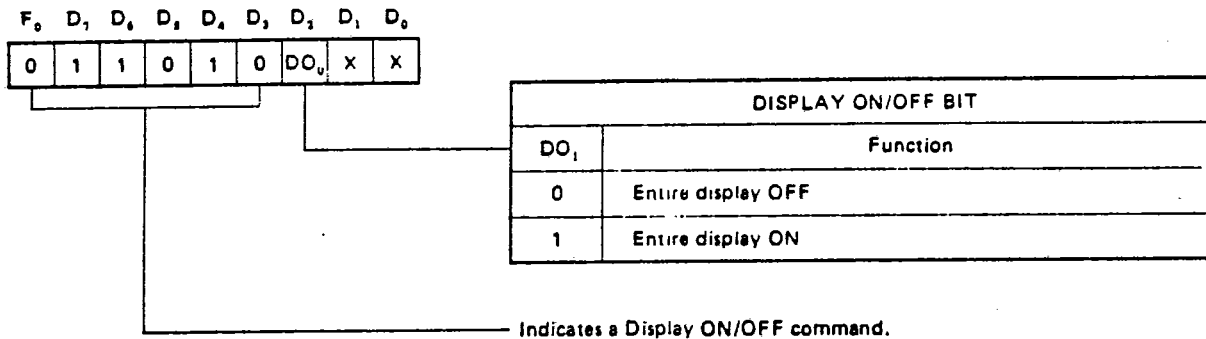

10.2 LINE DISPLAY OFF/BLANK

It is possible to display an entire line or erase it by writing color word address (CW₁, CW₀)=(1,1) in line color control register (CCR_{0 to 4}). The address is written using the line color specification command. (See section explaining line color specification.)

The display is set to off or blank using bit 1 (FS₀)* of the function selection command.

Blank: For no background or fringe background, no character or fringe is output. For square background or solid background, no characters are output, but the background remains.

Display OFF: For square background, no characters or background is output. For no background/fringe/solid background, the display is made blank the same way as above.

10.3 DISPLAY OFF/BLANK IN ONE A LINE

If it is not necessary to display data in one line, it is possible to display or make the display blank beginning from an address to the end of the line by writing line display OFF data (CH₅, CH₄, CH₃, CH₂, CH₁, CH₀)=(1,1,1,1,1,1) at the address. Specify to display or make it blank using bit (FS₀)* of the function selection command (as for B-line display OFF/Blank. Like color change data, line display OFF data can be changed to character data with bit (FS₁)* of the function selection command.

* For an explanation of the function selection command, see section on color specification in one line by color changing data

3115

411

10.4 SINGLE CHARACTER DISPLAY OFF/BLANK

A displayed character can be erased by setting blank data (CH₅, CH₄, CH₃, CH₂, CH₁, CH₀)=(1,1,1,0,1,0) in the display address to be made blank using character data command. If the display address in which the blank data is set has no background or a fringe background, no character is output. Otherwise, the background remains, but no character is output.

In the case of square background, if no character or background is to be output, set display OFF data (CH₅, CH₄, CH₃, CH₂, CH₁, CH₀)=(1,1,1,0,1,1) using character data command. For other cases, a character is output even if the display OFF data is set.

Character Data Command

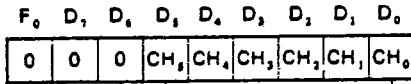

CHARACTER DATA BIT						
CH ₅	CH ₄	CH ₃	CH ₂	CH ₁	CH ₀	Display data
0	0	0	0	0	0	Character data (58 types)
1	1	1	0	0	1	
1	1	1	0	1	0	Blank
1	1	1	0	1	1	Display OFF (square background)/ Character data (no background, fringe, or solid background)
1	1	1	1	0	0	Color change data/character data ¹⁾
1	1	1	1	0	1	
1	1	1	1	1	0	
1	1	1	1	1	1	Line display OFF data/character data ²⁾

- 1) See section explaining line character color specification using color changing data.
- 2) See section explaining display OFF/Blank in one line.

Indicates character data command.

11. SMOOTHING FUNCTION

Display is made in a 5X7 dot matrix. The μPD6105C can initiate the smoothing function using bit (FS₃) of the function selection command.

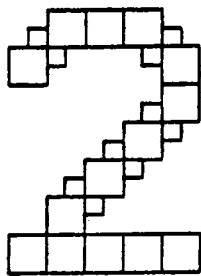
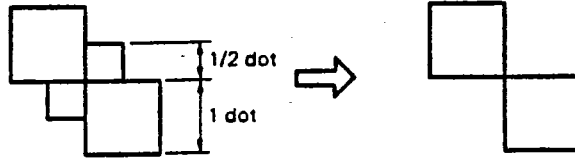

With smoothing function
μPD6104C
μPD6105C
(FS₃ = 1)

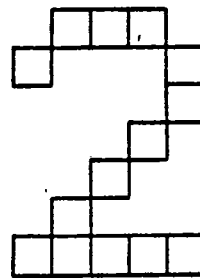

Without smoothing function
μPD6105C
(FS₃ = 0)

Function Selection Command

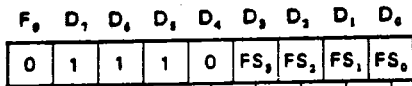

Blank/off selection bit
 (See section explaining display on/off control.)

Color change data / Character data change bit
 Line Display off data
 (See section explaining color specification in one line using color change data, and section explaining Display off/blank in one line.)

Division on/off change bit for second and third lines
 (See section explaining display position.)

SMOOTHING FUNCTION ON/OFF BIT	
FS ₀	Function
0	With smoothing function
1	Without smoothing function

Indicates function selection command.

After format resetting, FS₀=1 is set (with smoothing function).

FD6105C 002

NEC ELECTRONICS

TIMING DIAGRAM OF DATA INPUT

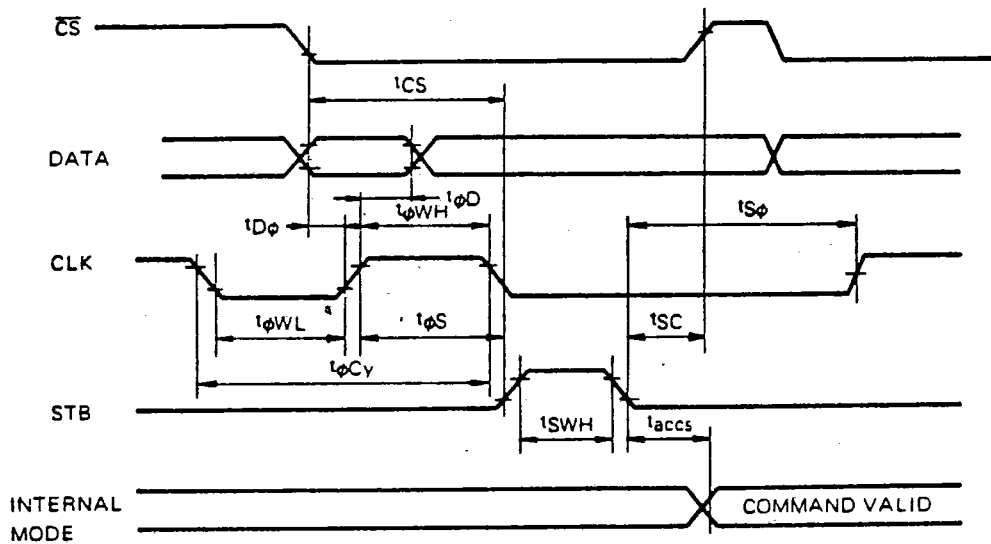
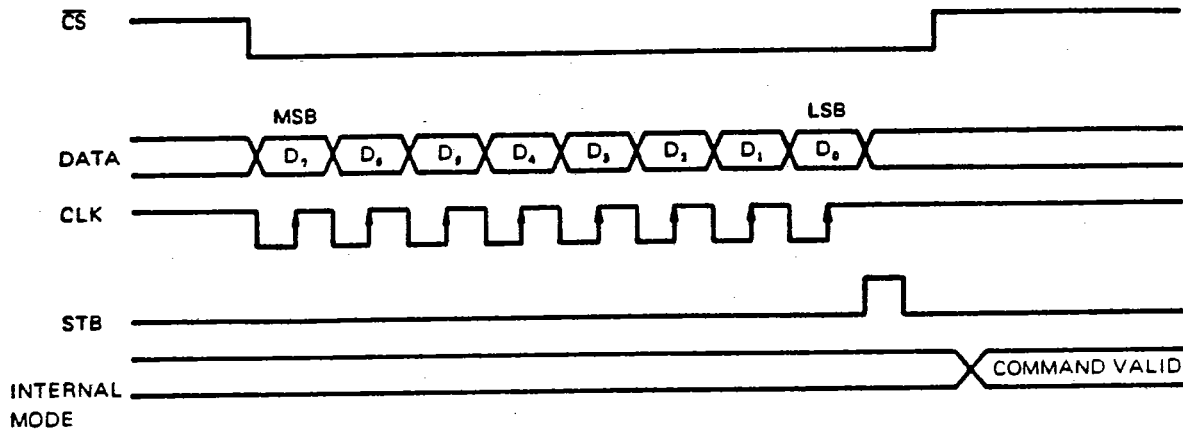

SYMBOL	MIN.	TYP.	MAX.	UNIT
t _{Dφ}	200			ns
t _{φD}	200			ns
t _{φWL}	700			ns
t _{φWH}	700			ns
t _{φS}	400			ns
t _{SWH}	1			μs
t _{CS}	400			ns
t _{SC}	200			ns
t _{accs}	1			μs
t _{φcy}	1.6			μs
t _{Sφ}	4			μs

(T_a = 25 °C, V_{DD} - V_{SS} = 5.0 V)



APPLICATION CIRCUIT

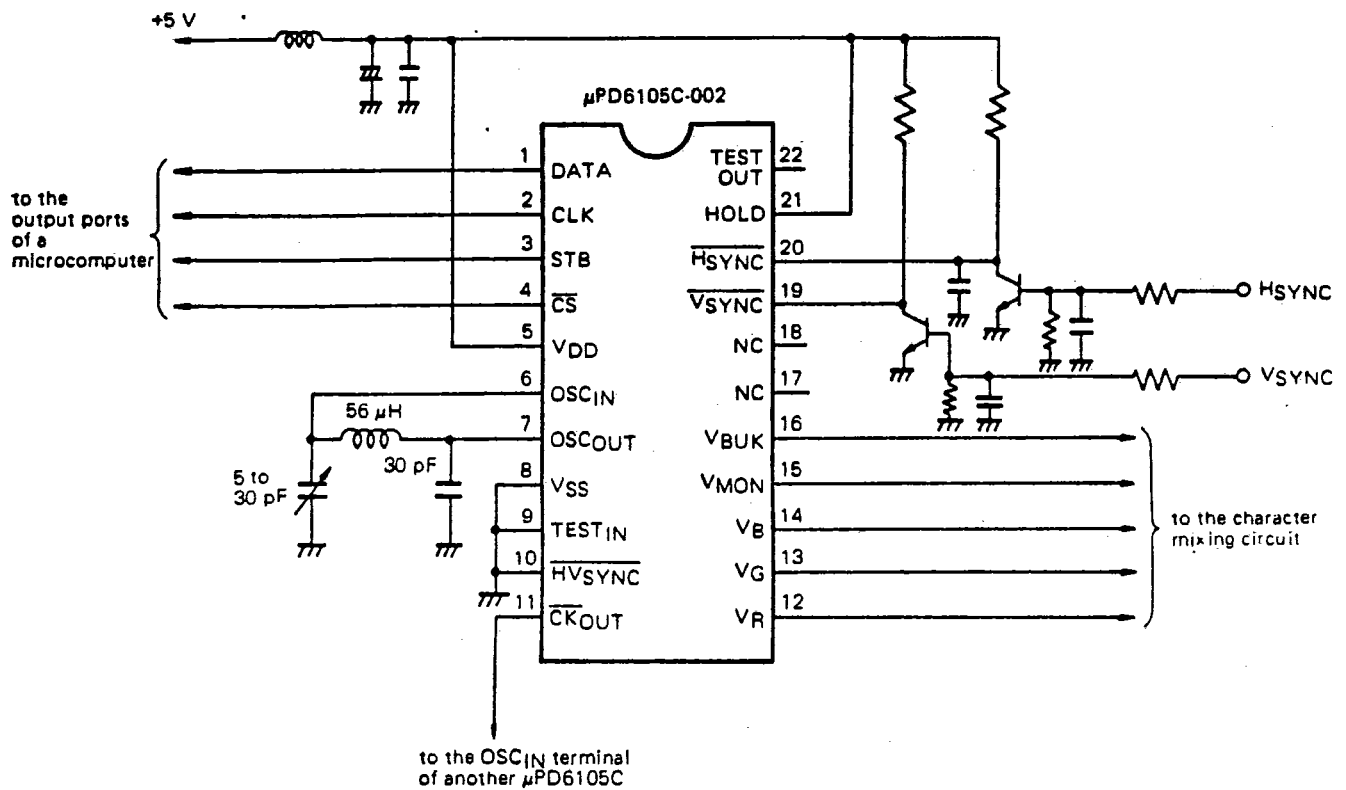

22PIN PLASTIC DIP (400 mil)

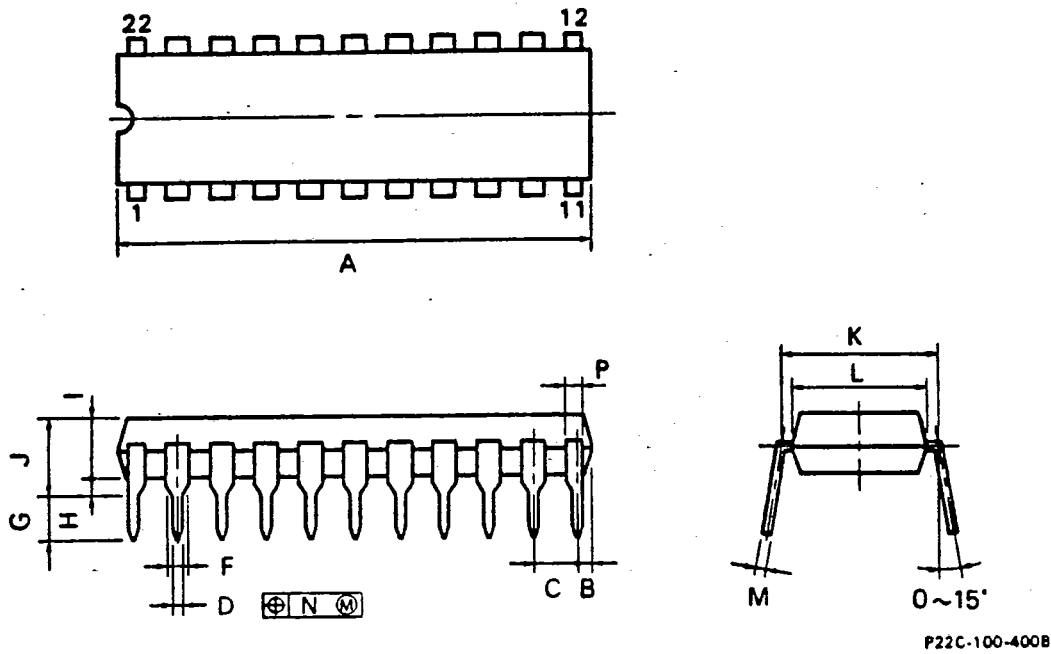

NOTES

- 1) Each lead centerline is located within 0.25 mm (0.01 inch) of its true position (T.P.) at maximum material condition.
- 2) Item "K" to center of leads when formed parallel.

ITEM	MILLIMETERS	INCHES
A	27.94 MAX.	1.100 MAX.
B	1.27 MAX.	0.050 MAX.
C	2.54 (T.P.)	0.100 (T.P.)
D	0.50 ^{10 10}	0.020 ^{8 88}
F	1.2 MIN.	0.047 MIN.
G	3.5 ^{10 3}	0.138 ^{10 012}
H	0.51 MIN.	0.020 MIN.
I	4.31 MAX.	0.170 MAX.
J	5.72 MAX.	0.226 MAX.
K	10.16 (T.P.)	0.400 (T.P.)
L	8.6	0.339
M	0.25 ^{8 88}	0.010 ^{8 88}
N	0.25	0.01
P	0.8 MIN.	0.031 MIN.

NEC Corporation

INTERNATIONAL ELECTRON DEVICES DIV.
 SUMITOMO MITA Building, 37-8,
 Shiba Gochome, Minato-ku, Tokyo 108, Japan
 Tel: Tokyo 456-3111
 Telex Address: NECTOK J22686
 Cable Address: NEC TOKYO