

Description

GM7130 of regulators provides all the active functions for a step-down (buck) switching regulator, and drives 3A load with excellent line and load regulation. GM7130 is available in fixed output voltages of 3.3V, 5V, 12V 15V, and a versatile Adjustable output version. These regulators are simple to use and require a minimum number of external components. Features include internal frequency compensation and a fixed-frequency oscillator.

The GM7130 is high-efficiency replacements for popular three-terminal linear regulators, and is requiring a smaller heatsink or even no heatsink.

GM7130 performs well with standard inductors from several manufacturers, and simplifying the design of switch-mode power supplies. GM7130 guarantees $\pm 4\%$ tolerance on output voltage within specified input voltages and output load conditions, and $\pm 10\%$ on the oscillator frequency.

External shutdown is induced with 50 μA (typical) standby current. The output switch has cycle-by-cycle current limiting as well as thermal shutdown for full protection under fault conditions.

Features

- ◆ 3.3V, 5V, 12V, 15V, Adjustable output versions
- ◆ Adjustable version output voltage range 1.23V to 37V $\pm 4\%$ max over line and load conditions
- ◆ 3A output current
- ◆ Input voltage range 7V to 40V
- ◆ Requires only 4 external components
- ◆ High efficiency
- ◆ TTL shutdown capability, low power standby mode
- ◆ Thermal shutdown, current limit protection
- ◆ Uses standard inductors
- ◆ 52 kHz fixed frequency internal oscillator

Application

Pre-regulator for linear regulators
High-efficiency step-down buck regulator

On-card/ board switching regulators
Positive to negative converter (buck-boost)

TYPICAL APPLICATIONS

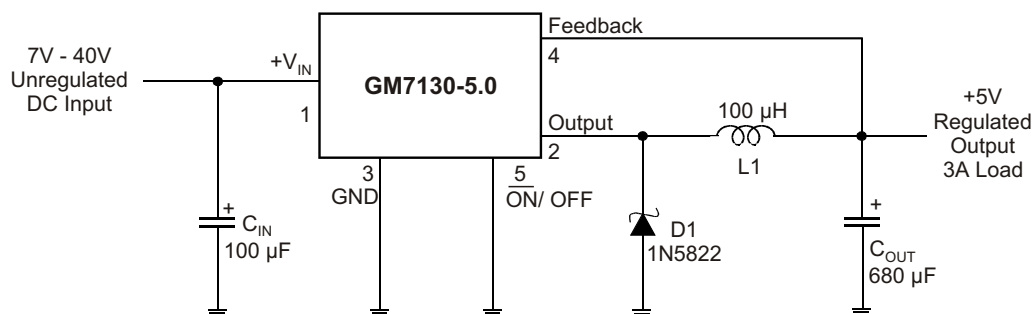

3A STEP-DOWN VOLTAGE SWITCHING REGULATORS

◆ MARKING INFORMATION & PIN CONFIGURATIONS (Top View)

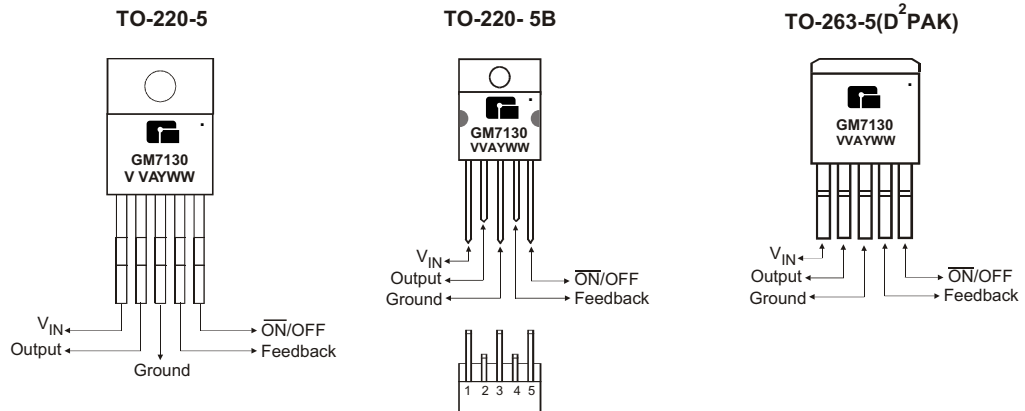

V V, VVV = Output Voltage (33 = 3.3V, 120= 12V, A =Adj)
 A = Assembly Location
 Y =Year
 W W =Weekly

◆ ORDERING INFORMATION

Ordering Number	Output Voltage	Package	Shipping
GM7130-ATB5T	Adj	TO-220-5	50 Units / Tube
GM7130-ATB5BT	Adj	TO-220-5B	50 Units / Tube
GM7130-ATA5R	Adj	TO-263-5	800 Units/ Tape & Reel
GM7130-ATA5T	Adj	TO-263-5	50 Units / Tube
GM7130-3.3TB5T	3.3	TO-220-5	50 Units / Tube
GM7130-3.3TB5BT	3.3	TO-220-5B	50 Units / Tube
GM7130-3.3TA5R	3.3	TO-263-5	800 Units/ Tape & Reel
GM7130-3.3TA5T	3.3	TO-263-5	50 Units / Tube
GM7130-5.0TB5T	5.0	TO-220-5	50 Units / Tube
GM7130-5.0TB5BT	5.0	TO-220-5B	50 Units / Tube
GM7130-5.0TA5R	5.0	TO-263-5	800 Units/ Tape & Reel
GM7130-5.0TA5T	5.0	TO-263-5	50 Units / Tube
GM7130-12TB5T	12	TO-220-5	50 Units / Tube
GM7130-12TB5BT	12	TO-220-5B	50 Units / Tube
GM7130-12TA5R	12	TO-263-5	800 Units/ Tape & Reel
GM7130-12TA5T	12	TO-263-5	50 Units / Tube
GM7130-15TB5T	15	TO-220-5	50 Units / Tube
GM7130-15TB5BT	15	TO-220-5B	50 Units / Tube
GM7130-15TA5R	15	TO-263-5	800 Units/ Tape & Reel
GM7130-15TA5T	15	TO-263-5	50 Units / Tube

* TB5B: Bent and Staggered Leads of TO-220 package

** For detail Ordering Number identification, please see last page.

3A STEP-DOWN VOLTAGE SWITCHING REGULATORS

◆ ABSOLUTE MAXIMUM RATINGS

Rating	Value	Unit
Maximum Supply Voltage	45	V
$\overline{\text{ON}}/\text{OFF}$ Pin Input Voltage	$-0.3 \leq V \leq V_{\text{IN}}$	V
Output Voltage to Ground (Steady State)	-1.0	V
Power Dissipation	Internally Limited	-
Storage Temperature Range	-65 to + 150	°C
Maximum Junction Temperature	+150	°C
Minimum ESD Rating (C=100pF, R=1.5k)	2	kV
Lead Temperature (Soldering, 10 seconds)	+260	°C

◆ OPERATING RATINGS

Rating	Value	Unit
Operating Temperature Range	$-40 \leq T_J \leq 125$	°C
Supply Voltage	40	V

◆ BLOCK DIAGRAM

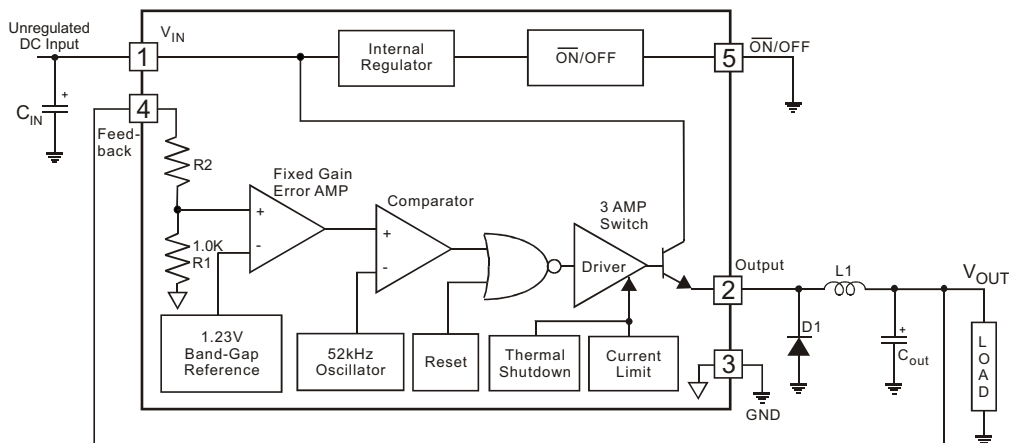

3A STEP-DOWN VOLTAGE SWITCHING REGULATORS

◆ ELECTRICAL CHARACTERISTICS: GM7130-3.3

(Specifications with standard type face are for $T_J = 25^\circ\text{C}$, and those with **boldface type** apply over full Operating Temperature Range)

Parameter	Conditions	Symbol	Min	Typ	Max	Unit
Output Voltage	$V_{IN} = 12\text{V}, I_{LOAD} = 0.5\text{A}$	V_{OUT}	3.234	3.3	3.366	V
Output Voltage - GM7130	$6\text{V} \leq V_{IN} \leq 40\text{V}, 0.5\text{A} \leq I_{LOAD} \leq 3.0\text{A}$	V_{OUT}	3.168/ 3.135	3.3	3.432/ 3.465	V
Efficiency	$V_{IN} = 12\text{V}, I_{LOAD} = 3.0\text{A}$		-	75	-	%

◆ ELECTRICAL CHARACTERISTICS: GM7130-5.0

(Specifications with standard type face are for $T_J = 25^\circ\text{C}$, and those with **boldface type** apply over full Operating Temperature Range)

Parameter	Conditions	Symbol	Min	Typ	Max	Unit
Output Voltage	$V_{IN} = 12\text{V}, I_{LOAD} = 0.5\text{A}$	V_{OUT}	4.900	5.0	5.100	V
Output Voltage - GM7130	$8\text{V} \leq V_{IN} \leq 40\text{V}, 0.5\text{A} \leq I_{LOAD} \leq 3.0\text{A}$	V_{OUT}	4.800/ 4.750	5.0	5.200/ 5.250	V
Efficiency	$V_{IN} = 12\text{V}, I_{LOAD} = 3.0\text{A}$		-	77	-	%

◆ ELECTRICAL CHARACTERISTICS: GM7130-12

(Specifications with standard type face are for $T_J = 25^\circ\text{C}$, and those with **boldface type** apply over full Operating Temperature Range)

Parameter	Conditions	Symbol	Min	Typ	Max	Unit
Output Voltage	$V_{IN} = 25\text{V}, I_{LOAD} = 0.5\text{A}$	V_{OUT}	11.76	12.0	12.24	V
Output Voltage - GM7130	$15\text{V} \leq V_{IN} \leq 40\text{V}, 0.5\text{A} \leq I_{LOAD} \leq 3.0\text{A}$	V_{OUT}	11.52/ 11.40	12.0	12.48/ 12.60	V
Efficiency	$V_{IN} = 15\text{V}, I_{LOAD} = 3.0\text{A}$		-	88	-	%

◆ ELECTRICAL CHARACTERISTICS: GM7130-15

(Specifications with standard type face are for $T_J = 25^\circ\text{C}$, and those with **boldface type** apply over full Operating Temperature Range)

Parameter	Conditions	Symbol	Min	Typ	Max	Unit
Output Voltage	$V_{IN} = 25\text{V}, I_{LOAD} = 0.5\text{A}$	V_{OUT}	14.70	15.0	15.30	V
Output Voltage - GM7130	$18\text{V} \leq V_{IN} \leq 40\text{V}, 0.5\text{A} \leq I_{LOAD} \leq 3.0\text{A}$	V_{OUT}	14.40/ 14.25	15.0	15.60/ 15.75	V
Efficiency	$V_{IN} = 18\text{V}, I_{LOAD} = 3.0\text{A}$		-	88	-	%

3A STEP-DOWN VOLTAGE SWITCHING REGULATORS

◆ ELECTRICAL CHARACTERISTICS: GM7130-ADJ

(Specifications with standard type face are for $T_j = 25^\circ\text{C}$, and those with **boldface type** apply over full Operating Temperature Range)

Parameter	Conditions	Symbol	Min	Typ	Max	Unit
Feedback Voltage	$V_{IN} = 12\text{V}$, $I_{LOAD} = 0.5\text{A}$, $V_{OUT} = 5\text{V}$	V_{OUT}	1.217	1.230	1.243	V
Feedback Voltage - GM7130	$8\text{V} \leq V_{IN} \leq 40\text{V}$, $0.5\text{A} \leq I_{LOAD} \leq 3.0\text{A}$ $V_{OUT} = 5\text{V}$	V_{OUT}	1.193/ 1.180	1.230	1.267/ 1.280	V
Efficiency	$V_{IN} = 12\text{V}$, $I_{LOAD} = 3\text{A}$, $V_{OUT} = 5\text{V}$		-	77	-	%

◆ ELECTRICAL CHARACTERISTICS: All Output Voltage Versions

(Specifications with standard type face are for $T_j = 25^\circ\text{C}$, and those with **boldface type** apply over full Operating Temperature Range. Unless otherwise specified, $V_{IN} = 12\text{V}$ for the 3.3V, 5.0V and ADJ version, $V_{IN} = 25\text{V}$ for 12V version. and $V_{IN} = 30\text{V}$ for 15V version. $I_{LOAD} = 500\text{mA}$)

Parameter	Conditions	Symbol	Min	Typ	Max	Unit
Feedback Bias Current	$V_{OUT} = 5\text{V}$ (Adjustable Version Only)	I_b	-	50	100 / 500	nA
Oscillator Frequency	(Note 11)	f_o	47 / 42	52	58 / 63	kHz
Saturation Voltage	$I_{OUT} = 3\text{A}$ (Notes 4)	V_{SAT}	-	1.4	1.8 / 2.0	V
Max Duty Cycle (ON)	(Note 5)	DC	93	98	-	%
Current Limit	(Note 4, 11)	I_{CL}	4.2 / 3.5	5.8	6.9 / 7.5	A
Output Leakage Current	(Notes 6, 7) Output = -1 V Output = -1V	I_L	-	- 7.5	2 30	mA
Quiescent Current	(Note 6)	I_Q	-	5	10	mA
Standby Quiescent Current	$\overline{\text{ON/OFF}}$ Pin = 5V (OFF)	I_{STBY}	-	50	200	μA
Thermal Resistance	TO-220 Package, Junction to Ambient (Note 8)	JA	-	65	-	$^\circ\text{C/W}$
	TO-220 Package, Junction to Ambient (Note 9)	JA	-	45	-	
	TO-220, TO-263 Package, Junction to Case	JC	-	2	--	
	TO-263 Package, Junction to Ambient (Note 10)	JA	-	50	-	
$\overline{\text{ON/OFF}}$ Pin	$V_{OUT} = 0\text{V}$	V_{IH}	2.2 / 2.4	1.4	-	V
Logic Input Level	$V_{OUT} = \text{Nominal Output Voltage}$	V_{IL}	-	1.2	1.0 / 0.8	V
$\overline{\text{ON/OFF}}$ Pin Input Current	$\overline{\text{ON/OFF}}$ Pin = 5V (OFF)	I_{IH}	-	12	30	μA
	$\overline{\text{ON/OFF}}$ Pin = 0V (ON)	I_{IL}	-	0	10	μA

◆ ELECTRICAL CHARACTERISTICS

Note 1: Absolute Maximum Ratings indicate limits beyond which damage to the device may occur. Operating Ratings indicate conditions for which the device is intended to be functional, but do not guarantee specific performance limits. Guaranteed specifications and Test conditions are shown in Electrical Characteristics.

Note 2: All limits guaranteed at 25°C (standard type face) and over full operating temperature range (bold type face). All 25°C limits are 100% production tested. All limits over full operating temperature range are guaranteed via correlation using standard Statistica Quality Control methods.

Note 3: External components such as the catch diode, inductor, input and output capacitors can affect switching regulator system performance. When the GM7130 is used as shown in the Figure 1 test circuit, system performance will be as shown in system parameters section of Electrical Characteristics.

Note 4: Output pin sourcing current. No diode, inductor or capacitor connected to output.

Note 5: Feedback pin removed from output and connected to 0V.

Note 6: Feedback pin removed from output and connected to +12V for the Adjustable, 3.3V, and 5V versions, and +25V for the 12V and 15V versions, to force the output transistor OFF.

Note 7: $V_{IN} = 40V$

Note 8: Junction to ambient thermal resistance (no external heat sink) for the 5 lead TO-220 package mounted vertically, with ½ inch leads in a socket, or on a PC board with minimum copper area.

Note 9: Junction to ambient thermal resistance (no external heat sink) for the 5 lead TO-220 package mounted vertically, with ¼ inch leads soldered to a PC board containing approximately 4 square inches of copper area surrounding the leads.

Note 10: If the TO-263 package is used, the thermal resistance can be reduced by increasing the PC board Copper area thermally connected to the package. Using 0.5 square inches of copper area, θ_{JA} is 50°C/W, with 1 square inch of copper area, θ_{JA} is 37°C/W, and with 1.6 or more square inches of copper area, θ_{JA} is 32°C/W.

Note 11: The oscillator frequency reduces to approximately 11 kHz in the event of an output short or an Overload which causes the regulated output voltage to drop approximately 40% from the nominal output voltage. This self- protection feature lowers the Average power dissipation of GM7130 by lowering the minimum duty cycle from 5% down to approximately 2%.

◆ TEST CIRCUIT AND LAYOUT GUIDELINES

Careful layout is important with any switching regulator. Rapidly switching currents associated with wiring inductance generate voltage transients which can cause problems. To minimize inductance and ground loops, the lengths of the leads indicated by heavy lines in Figure 1 below should be kept as short as possible. Single-point grounding (as indicated in Figure 1) or ground plane construction should be used for best results. When using the Adjustable version, place the programming resistors as close as possible to Gm7130, to keep the sensitive feedback wiring short.

Figure 1(a). Fixed Output Voltage Versions

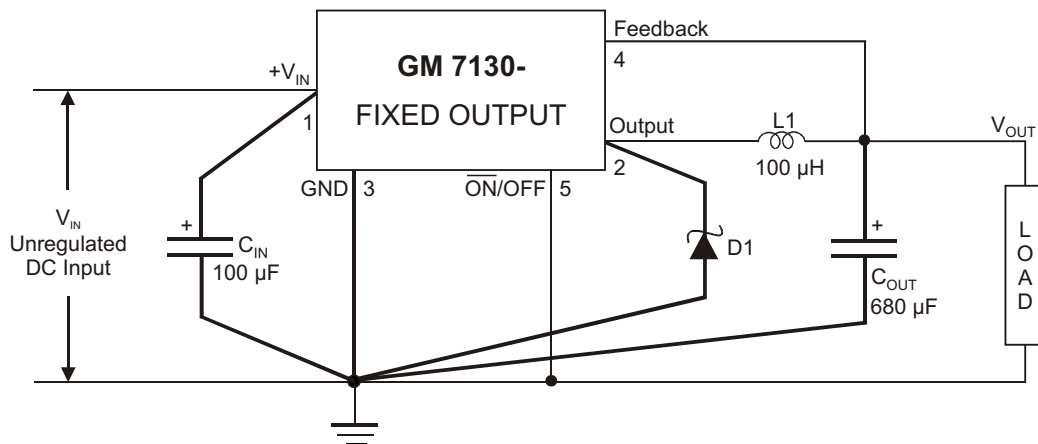

C_{IN} - 100 μ F, 75V, Aluminum Electrolytic

C_{OUT} - 680 μ F, 25V, Aluminum Electrolytic

D1 - Schottky, MBR360

L1 - 100 μ H, 3L Electronic Corp. TC-101M-3.0A-6826

R1 - 2k, 0.1%

R2 - 6.12k, 0.1%

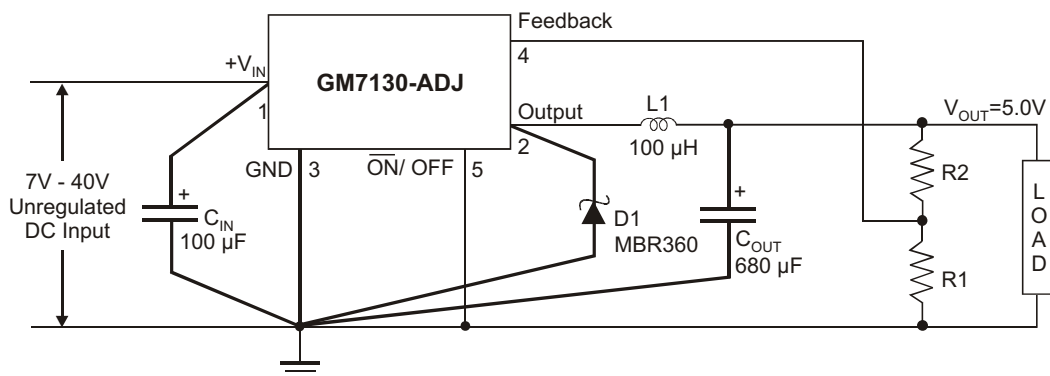

$$V_{OUT} = V_{REF} \left(1 + \frac{R2}{R1} \right)$$

$$R2 = R1 \left(\frac{V_{OUT}}{V_{REF}} - 1 \right)$$

where $V_{REF} = 1.23V$, $R1$ between 1k and 5k.

Figure 1(b). Adjustable Output Voltage Versions

◆ Typical Performance Characteristics

Figure 2. Switch Saturation Voltage

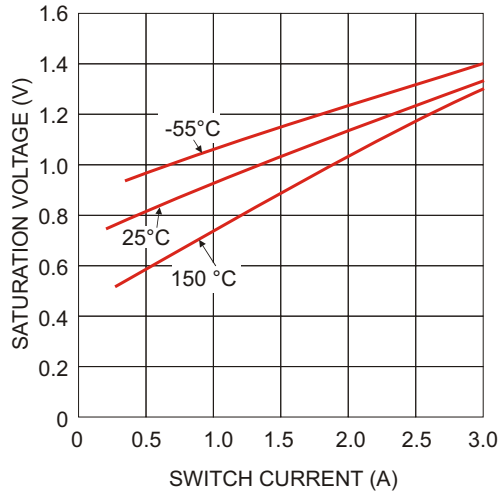

Figure 3. Current Limit

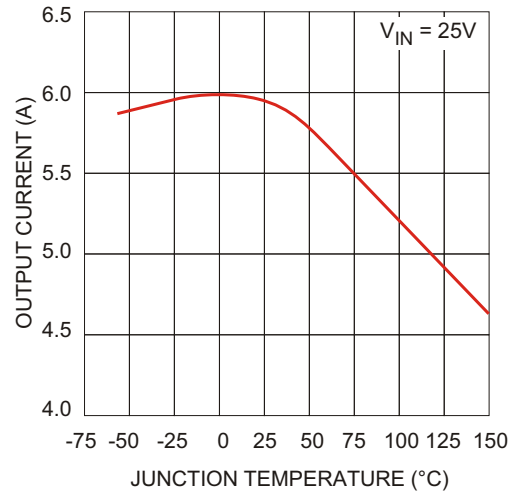

Figure 4. Dropout Voltage

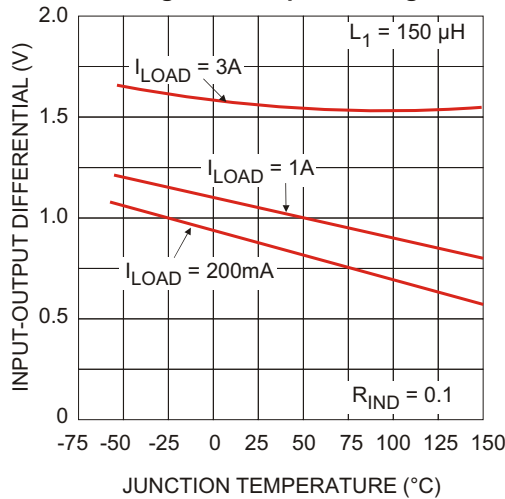

Figure 5. Quiescent Current

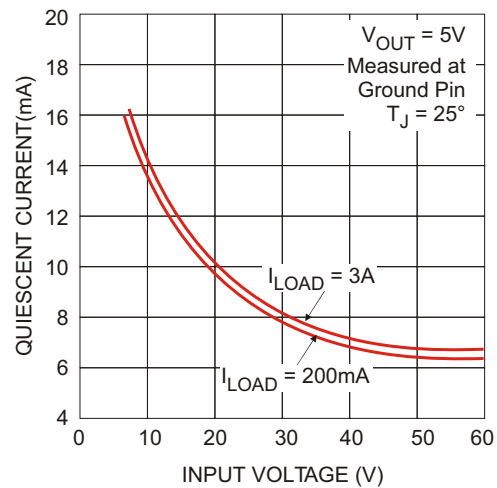

Figure 6. Standby Quiescent Current

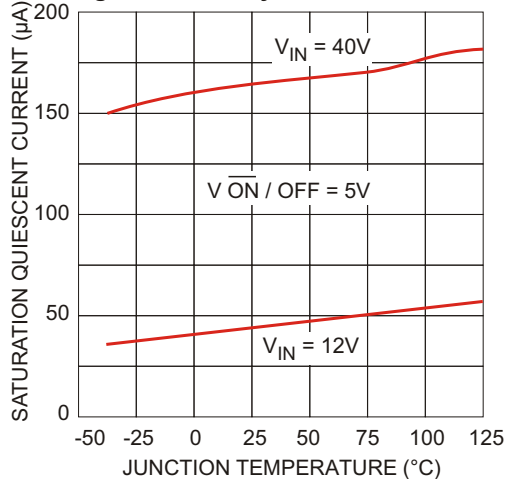
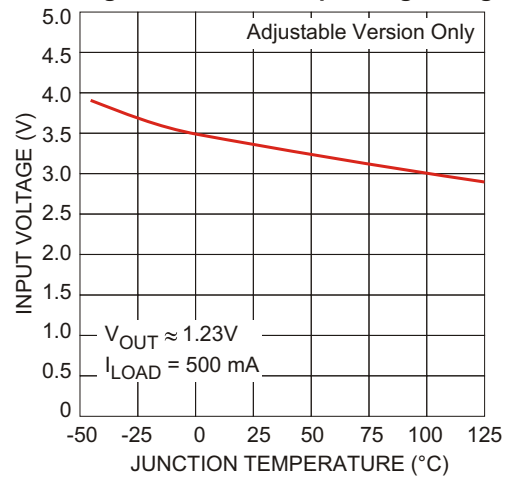

Figure 7. Minimum Operating Voltage



◆ Typical Performance Characteristics

Figure 8. Quiescent Current vs. Duty Cycle

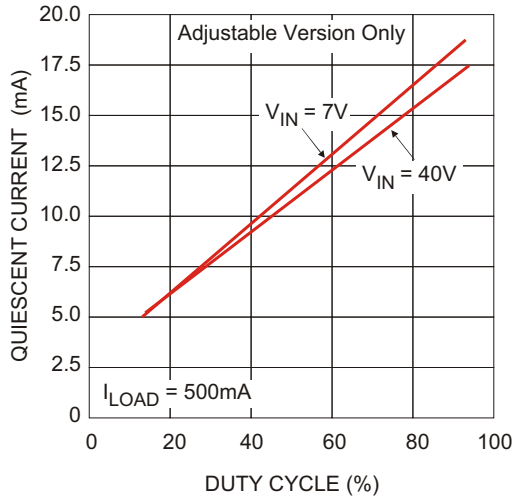

Figure 9. Feedback Voltage vs. Duty Cycle

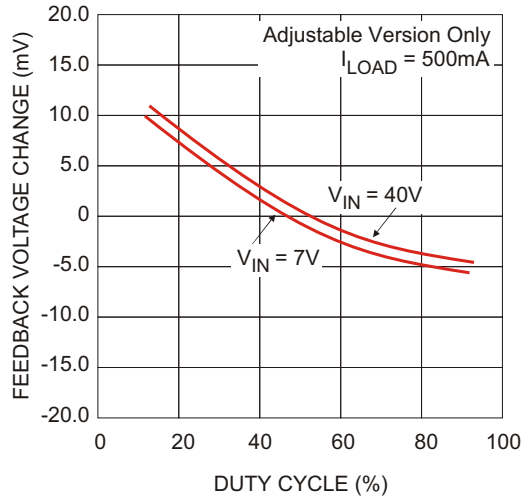

Figure 10. Maximum Power Dissipation(TO-263)

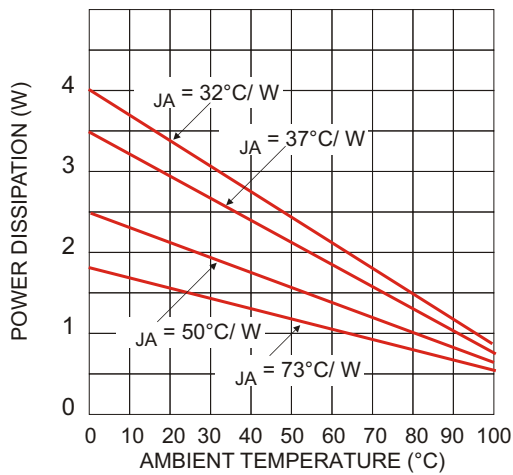
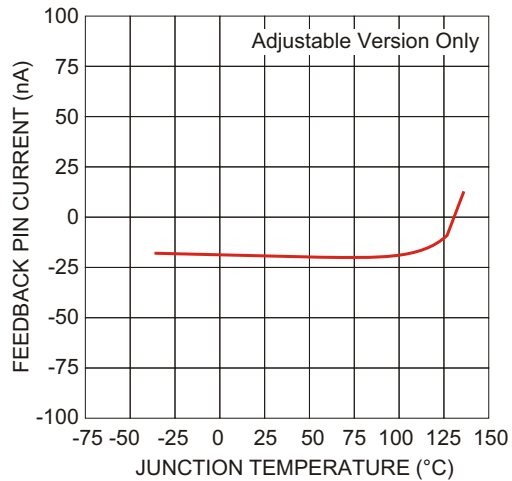

Figure 11. Feedback Pin Current



◆ Typical Performance Characteristics

Figure 12. Switching Waveforms

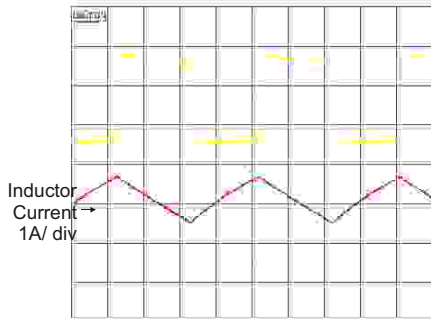
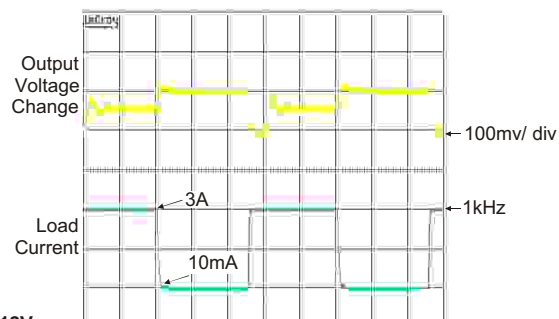

Figure 13. Load Transient Response



Input : 12V
Output : 5V @3A

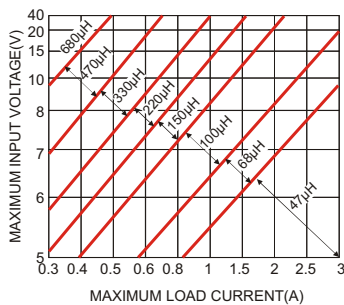

Figure 14. GM7130 -3.3

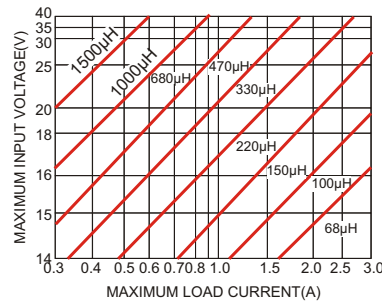

Figure 15. GM7130 -12

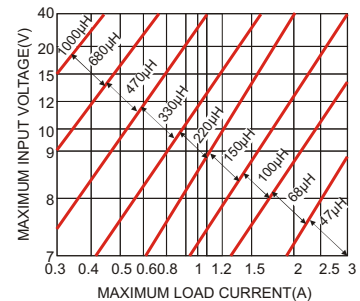

Figure 16. GM7130 -5.0

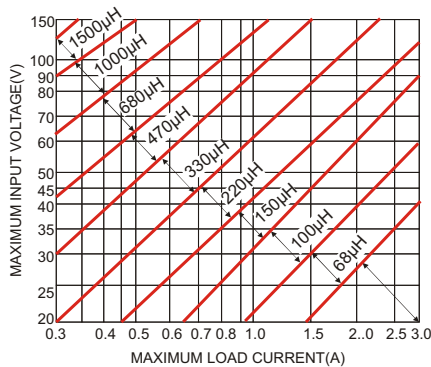

Figure 17. GM7130 -ADJ

$$E \cdot T = (V_{IN} - V_{OUT}) \frac{V_{OUT}}{V_{IN}} \cdot \frac{1,000}{F(\text{in kHz})}$$

PROCEDURE(Adjustable Output Voltage Versions)

Given:

- V_{OUT} = Regulated Output Voltage
- $V_{IN}(\text{Max})$ = Maximum Input Voltage
- $I_{LOAD}(\text{Max})$ = Maximum Load Current
- F = Switching Frequency (Fixed at 52 kHz)

1. Programming Output Voltage(Selecting R1 and R2, as shown in Figure 12. And Figure 13.

Use the following formula to select the appropriate resistor values.

$$V_{OUT} = V_{REF} \left(1 + \frac{R_2}{R_1} \right) \quad \text{where } V_{REF} = 1.23V$$

R_1 can be between 1k and 5k. (For best temperature coefficient and stability with time, use 1% metal film resistors)

$$R_2 = R_1 \left(\frac{V_{OUT}}{V_{REF}} - 1 \right)$$

EXAMPLE (Adjustable Output Voltage Versions)

Given:

- $V_{OUT} = 10V$
- $V_{IN}(\text{Max}) = 25V$
- $I_{LOAD}(\text{Max}) = 3A$
- $F = 52kHz$

1. Programming Output Voltage (Selecting R1 and R2)

$$V_{OUT} = 1.23 \left(1 + \frac{R_2}{R_1} \right) \quad \text{Select } R_1 = 1k$$

$$R_2 = R_1 \left(\frac{V_{OUT}}{V_{REF}} - 1 \right) = 1k \left(\frac{10V}{1.23V} - 1 \right)$$

$R_2 = 1k (8.13 - 1) = 7.13k$, closest 1% value is 7.15k

◆ Inductor Selection by Manufacturer's Part Number.

Inductor Value	3L Electronic Corp.
47 μ H	TC-470M-3A-5026
68 μ H	TC-680M-3A-5026
100 μ H	TC-101M-3A-5026
150 μ H	TC-151M-3A-8026
220 μ H	TC-221M-3A-8026
330 μ H	TC-331M-3A-8026
470 μ H	TC-471M-3A-8026
680 μ H	TC-681M-3A-8026
1000 μ H	TC-102M-3A-9426
1500 μ H	TC-152M-3A-9426

3L Electronic Corp., + 886(2) 86659999
Website : www.3lcoil.com.tw

◆ Capacitor Selection by Manufacturer's Part Number

Capacitor Value	Nippon Chemil - Con Corp.
100 μ F	KY50VB100-MH11
220 μ F	KY50VB220-MJ16
470 μ F	KY50VB470-MJ30
680 μ F	KY50VB680-MK30
1000 μ F	KY50VB1000-ML25

Nippon Chemi-Con Corp., + 81(3)54367628
Website : www.chemi-con.co.jp

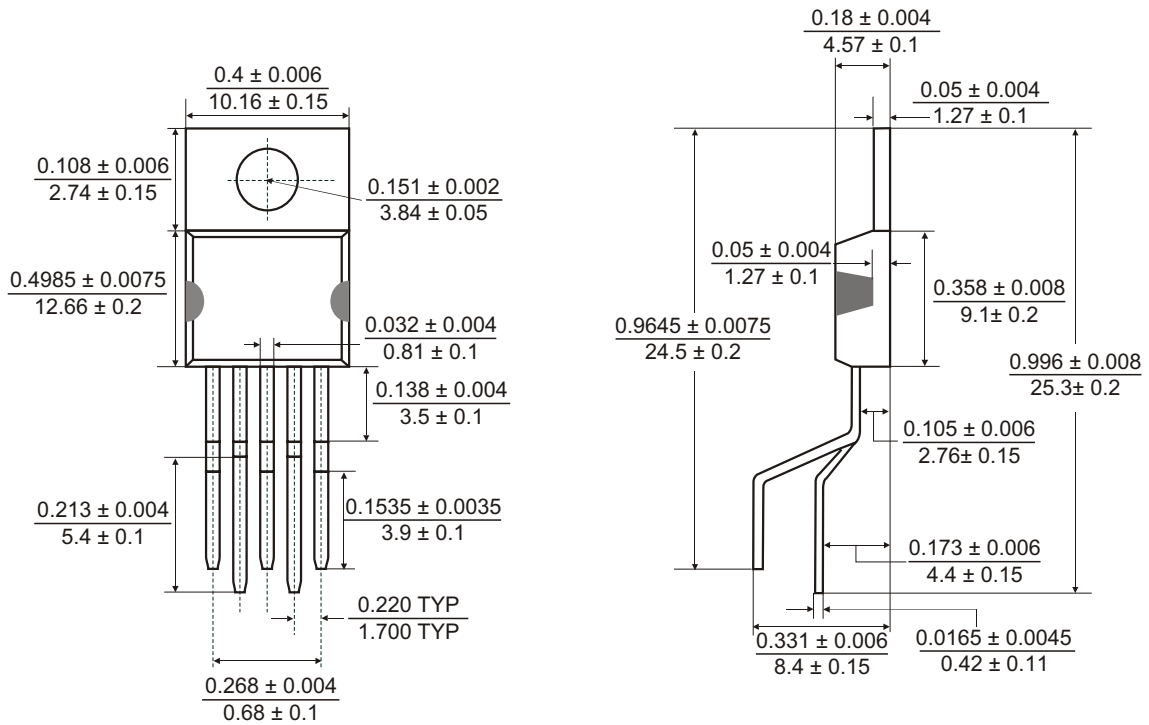

◆ TO-220-5B PACKAGE OUTLINE DIMENSIONS

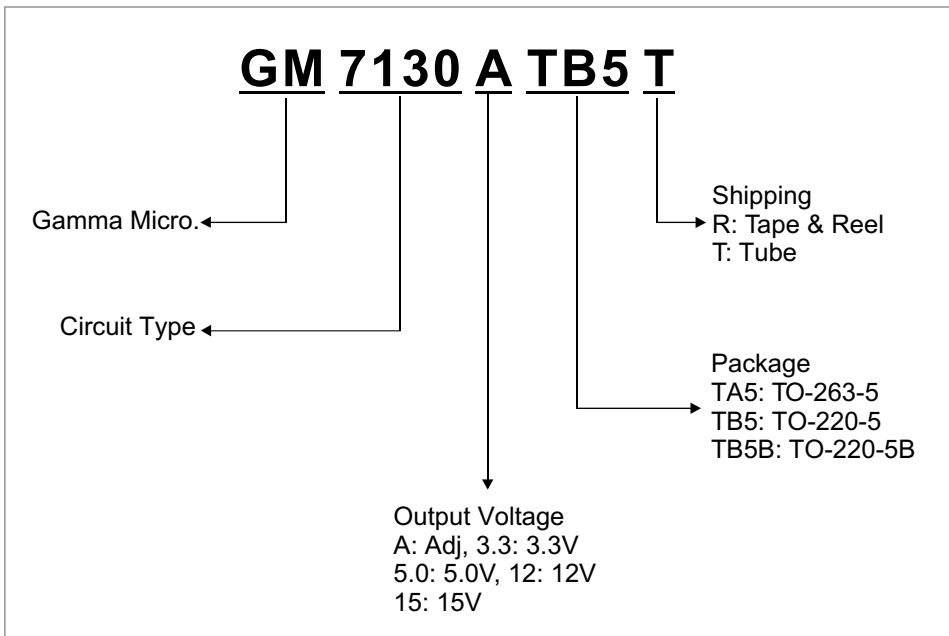

(Inches
mm)

◆ ORDERING NUMBER



GAMMA Micro, , and  are registered trademarks of GAMMA MICROELECTRONICS INC. GAMMA reserves the right to make changes without further notice to any products herein. Information provided herein is alleged to be exact and consistent and this publication surpasses and replaces all information previously supplied.

GAMMA makes no warranty the suitability of its products for any particular purpose, nor does GAMMA assume any liability arising out of the application or use of any product or circuit, and specifically disclaims any and all liability including without limitation special, consequential or incidental damages.

GAMMA products are not authorized for using as critical components in life support devices or systems without prior written approval from GAMMA MICROELECTRONICS INC.
