

AN8221FB

HDD Sensor-less Motor Driver IC

■ Overview

AN8221FB is a sensor-less motor drive IC which requires no sensors like a Hall element of spindle motor in HDD.

It employs the soft switch system of three-phase full wave drive.

■ Features

- Soft switch system (snubber-less)
- External/Internal clock change-over allowed
- External and internal synchronous start circuits built-in
- Small current in stand-by mode (typ. 10 μ A)
- Start current (output current) : 1A max.
- Short brake function provided
- CW/CCW switching terminal provided
- Current control and Thermal protective circuit provided

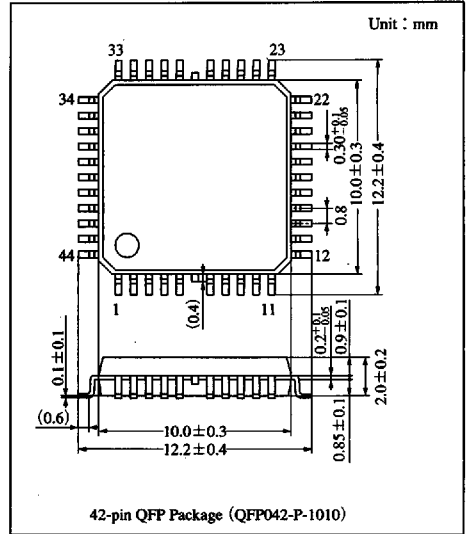

Pin Descriptions

Pin No.	Symbol	Pin name	Pin No.	Symbol	Pin name
1	U	U-phase output terminal	23	OSC1	Oscillation circuit terminal 1
2	V	V-phase output terminal	24	OSC2	Oscillation circuit terminal 2
3	W	W-phase output terminal	25	COM	Neutral point detection terminal
4	PG	Power ground	26	SG	Signal ground
5			27		
6			28		
7			29		
8			30		
9	SG	Signal ground	31	W1	W1 BEMF input terminal
10	V _{M1}	Monitor terminal 1	32	V1	V1 BEMF input terminal
11	V _{M2}	Monitor terminal 2	33	U1	U1 BEMF input terminal
12	W2	W2 waveform shaping output terminal	34	FG	FG output terminal
13	V2	V2 waveform shaping output terminal	35	SDO	Start/Detection switching output terminal
14	U2	U2 waveform shaping output terminal	36		NC
15	AI	Waveform shaping speed regulation terminal	37	CLK	External clock input terminal
16		NC	38	FR	Normal/Reverse rotation switching terminal
17	PCI	Phase compensation terminal	39	BR	Brake terminal
18	EAO	Error amp. output terminal	40	V _{CC}	Supply voltage terminal
19	EAI	Error amp. reverse input terminal	41	CS	Current detection terminal
20	V _{TE1}	Voltage monitor terminal 1	42	EIC	External/Internal clock switching terminal
21	V _{TE2}	Voltage monitor terminal 2	43	SDE	Start/Detection switching enabling terminal
22	S/S	Stand-by/Set-up terminal	44	SDI	Start/Detection switching terminal

Absolute Maximum Rating (T_a = 25°C)

Parameter	Symbol	Rating	Unit
Supply voltage	V _{CC}	6.5	V
Supply current	I _{CC}	—	mA
Motor output current	I _{Omax}	± 700	mA
Motor peak output current ^{Note)}	I _{CSmax}	± 1000	mA
Current detection input current	I _{Opeak}	+ 700	mA
Current detection peak input current ^{Note)}	I _{CSpeak}	+ 1000	mA
Motor output voltage	V _O	-0.3 to V _{CC} + 0.3	V
Input voltage	V _{22,38,39, 42,43,44}	-0.3 to V _{CC} + 0.3	V
Power dissipation (single unit)	P _D	752	mW
Operating ambient temperature	T _{opr}	-20 to +75	°C
Storage temperature	T _{stg}	-40 to +125	°C

Note) peak = 0.5sec or less

Recommended Operating Range

Parameter	Symbol	Range
Operating supply voltage	V _{CC}	4.5V to 5.5V

Electrical Characteristics ($V_{CC}=5V$, $T_a=25\pm 2^\circ C$)

Parameter	Symbol	Condition	min	typ	max	Unit
Stand-by supply current	$I_{stand\ by}$	$V_{S/S}=4.2V$	—	10	100	μA
Set-up supply current	$I_{SET\ UP}$	$V_{S/S}=0.8V$	—	10	15	mA
Error Amp.						
Open-loop gain	A_{EAG}		60	70	—	dB
Input bias current	I_{EAB}		—	20	100	nA
BEMF Detection						
Input bias current	I_B	Three times larger for I_{BCM} standard value	-0.8	-0.2	0.8	μA
Common-mode input voltage range	V_{BCM}		0.35	—	V_{CC} -1.1	V
OSC						
Charging/Discharging current	I_{DCH}	$V_{IN}=3V$	23	33	43	μA
	I_{CH}	$V_{IN}=0V$	-43	-33	-23	
Oscillation frequency error	f_{OSC}	$C=272$	2.3	3.0	3.7	kHz
FG						
Output high voltage	V_{HFG}	$I_{SIF}=-0.5mA$	30	4.2	—	V
Output low voltage	V_{LFG}	$I_{SOF}=0.5mA$	—	0.2	0.5	V
Drive Output System						
Saturation voltage 1 ($V_{sat\ upper\ 1} + V_{sat\ lower\ 1}$)	V_{sat1}	$I_o=100mA$	—	1.5	2.2	V
Saturation voltage 2 ($V_{sat\ upper\ 2} + V_{sat\ lower\ 2}$)	V_{sat2}	$I_o=100mA$	—	0.9	1.2	V
Off-time leak current	I_{LO}		-100	1	100	μA
Drive System						
Drive gain	G_D		0.76	0.95	1.14	Times
Current limiter voltage	V_{CL}	$R_1=20K, R_2=20K$	0.345	0.395	0.445	V
Current limiter delta voltage	ΔV_{CL}	$R_2=20K, R_3=60K$	-30	0	30	mV
Trapezoid Wave Shaping Block						
External CLK time output source current	I_{BEC}		-400	-300	-200	μA
External CLK time output sink current	I_{ABC}		350	—	550	μA
Internal CLK time output source current	I_{BIC}		-13	—	-7	μA
Internal CLK time output sink current	I_{AIC}		8	—	15.2	μA
Internal CLK time output delta current	ΔI_{IC}	$\Delta I_{IC}=I_{AIC}+I_{BIC}$	0.2	—	3.5	μA
Off-time leak current	I_{ZL}		-0.8	0	0.8	μA
Test voltage output block	V_{IO}		0.5	0.7	0.9	V
Test Monitor Voltage						
Test voltage 1	V_{TE1}		2.27	2.52	2.77	V
Test voltage 2	V_{TE2}		2.2	2.45	2.7	V
AI Terminal						
Input low current	I_{LAI}	Input Voltage=0.5V	-140	-100	-60	μA
SDO Terminal						
Output high voltage	V_{HSD}	$R=50K$	4.5	4.96	—	V
Output low voltage	V_{LSD}	$R=50K$	—	0.02	0.4	V
Output sink current	I_{LSD}		1	3	—	mA

Note) $V_{CC}=5V$ unless otherwise specified.

Electrical Characteristics (cont.) ($V_{CC}=5V$, $T_a=25\pm 2^\circ C$)

Parameter	Symbol	Condition	min	typ	max	Unit
FR Terminal						
Input high voltage	V_{HFR}		2	—	V_{CC}	V
Input low voltage	V_{LFR}		0	—	0.8	V
Input high current	I_{HFR}	Input voltage = 2.0V	55	110	220	μA
Input low current	I_{LFR}	Input voltage = 0.8V	-120	-70	-45	μA
BR Terminal						
Input high voltage	V_{HBR}		2	—	V_{CC}	V
Input low voltage	V_{LBR}		0	—	0.8	V
Input high current	I_{HBR}	Input voltage = 2.0V	55	110	220	μA
Input low current	I_{LBR}	Input voltage = 0.8V	-120	-70	-45	μA
EIC Terminal						
Input high voltage	V_{HEIC}		2	—	V_{CC}	V
Input low voltage	V_{LEIC}		0	—	0.8	V
Input high current	I_{HEIC}	Input voltage = 2.0V	55	110	220	μA
Input low current	I_{LEIC}	Input voltage = 0.8V	-120	-70	-45	μA
SDE Terminal						
Input high voltage	V_{HSDC}		2	—	V_{CC}	V
Input low voltage	V_{LSDC}		0	—	0.8	V
Input high current	I_{HSDC}	Input voltage = 2.0V	55	110	220	μA
Input low current	I_{LSDC}	Input voltage = 0.8V	-120	-70	-45	μA
SDI Terminal						
Input high voltage	V_{HSDI}		2	—	V_{CC}	V
Input low voltage	V_{LSDI}		0	—	0.8	V
Input high current	I_{HSDI}	Input voltage = 2.0V	55	110	220	μA
Input low current	I_{LSDI}	Input voltage = 0.8V	-120	-70	-45	μA
CLK Terminal						
Input high voltage	V_{HCLK}		2	—	V_{CC}	V
Input low voltage	V_{LCLK}		0	—	0.8	V
Input high current	I_{HCLK}	Input voltage = 2.0V	55	110	220	μA
Input low current	I_{LCLK}	Input voltage = 0.8V	-120	-70	-45	μA
S/S Terminal						
Input high voltage	$V_{HS/S}$		4.2	—	V_{CC}	V
Input low voltage	$V_{LS/S}$		0	—	0.8	V
Input high current	$I_{HS/S}$	Input voltage = 4.2V	-15	-4	—	μA
Input low current	$I_{LS/S}$	Input voltage = 0.8V	-500	-180	—	μA
Brake Block						
Brake time saturation voltage (V_{sat} lower)	V_{Bsat}	$I_O=700mA$	—	0.4	0.8	V
Logic Block						
Logic check A	I_{AA}	External CLK used	350	—	550	μA
Logic check A	I_{AB}	External CLK used	-400	—	-200	μA
Logic check A	I_{AZ}	External CLK used	-0.8	0	0.8	μA
Logic check B	I_{BA}	Internal OSC2 used	8	—	15.2	μA
Logic check B	I_{BB}	Internal OSC2 used	-13	—	-7	μA
Logic check B	I_{BZ}	Internal OSC2 used	-0.8	0	0.8	μA

■ Electrical Characteristics (cont.) ($V_{CC}=5V, T_a=25\pm 2^\circ C$)

Parameter	Symbol	Condition	min	typ	max	Unit
BEMF Detection						
Detection sensitivity level	V_{BDS}		—	3	20	mV

■ Electrical Characteristics (design reference values) ($V_{CC}=5V, T_a=25\pm 2^\circ C$)

Parameter	Symbol	Condition	min	typ	max	Unit
Error Amp.						
Gain/Band width product	f_T		—	800	—	kHz
Thermal Protection Circuit						
Thermal protection operation temperature	T_P		—	170	—	$^\circ C$
Thermal protection reset temperature	T_{PR}		—	125	—	$^\circ C$
Logic Block						
Start count number	N_{SC}	Internal OSC used	—	8	—	Counts
Trapezoidal Wave Shaping Block						
Output amplitude 1	V_{r1}	$C=223 (U2,V2,W2)$ $f_{osc2}=100Hz$	—	2	—	V
Output amplitude 2	V_{r2}	$C=223 (U2,V2,W2)$ $f_{osc2}=17.28kHz$	—	210	—	mV

Note) The above values are design reference values, but not guaranteed ones.

■ Package Power Dissipation

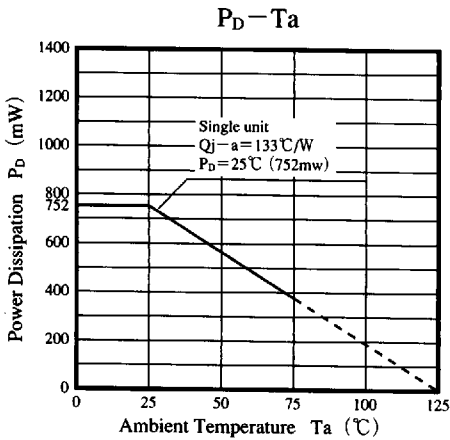

ICs for Motor

■ 6932852 0012859 619 ■

Panasonic

■ Pin Descriptions

Pin No.	Pin name	Function description
1~3	U,V,W	Motor drive terminal
4~8	PG	Power ground
9	SG	Signal ground
10	VM1	Monitor terminal 1
11	VM2	Monitor terminal 2
12~14	U2,V2,W2	It has function for shaping the waveform.
15	AI	It has function for switching the waveform shaping process speed.
16	NC	—
17	PCI	Terminal for phase compensation of the current feedback system.
18, 19	EAO,EAI	Circuit for integrating the deviation of the motor signal speed from the reference speed signal
20	VET1	The internal reference voltage connected to the reverse input of the buffer amp. and the non-reverse input of the error amp.
21	VET2	The internal reference voltage determining the reference set voltage of the triangular wave of the oscillation block
22	S/S	Low in the logic level for set-up mode, high in it for stand-by mode. The consumption current in the stand-by mode is approx. 10 μ A, typ.
23	OSC1	It outputs the rectangular wave synchronized with the triangular wave.
24	OSC2	It can set the oscillation frequency of triangular wave with the capacitor.
25	COM	Terminal inputting the neutral point of U, V and W.
26~30	SG	Signal ground
31~33	U1,V1,W1	Terminal detecting the inductive voltage coming from motor
34	FG	It stably takes out the output of FG synchronized with the U-phase coil waveform.
35	SDO	It takes out the output for switching between start and detection mode. For logic level, "High" for start mode and "Low" for detection mode.
36	NC	—
37	CLK	Synchronous operation allowed with external clock. The logic level can be commutated at the rise edge of external clock.
38	FR	It has function for rotating the motor normally or reversely. Energization to logic level : for normal rotation U→V→W→U→..., and for reverse rotation U→W→V→U→...
39	BR	It is used to stop the motor. The lower side transistor of U, V and W is shorted.
40	V _{cc}	Terminal supplying the supply voltage.
41	CS	Terminal detecting the current flowing in the motor.
42	EIC	Terminal switching the external/internal clock. When external clock is used, the logic level is "High." When the internal clock is used, it operates at the falling edge from "High" to "Low", and counts up with the count number fixed inside the IC. The start and detection modes are switched from each other automatically.
43	SDE	When the external clock is used, it allows the start/detection mode to be switched from outside. For logic level, "High" for operation and "Low" for stop.
44	SDI	When the external clock is used, it switches the start/detection mode from outside. It realizes synchronous operation with external clock in the start mode and operates the detection loop in the detection mode. For logic level, "High" for start mode and "Low" for detection mode.

Internal Circuits

Pin No.	Symbol	Internal circuit	Pin No.	Symbol	Internal circuit
1	U		13	V2	Same as for Pin 12
	V	Same as for Pin 1	14	U2	Same as for Pin 12
	W	Same as for Pin 1	15	AI	
4~8	PG	Power GND		16	NC
9	SG	Signal GND	17	PCI	
10	VM1			18	EAO
11	VM2		19		EA1
12	W2				

ICs for Motor

6932852 0012861 277

Internal Circuits (cont.)

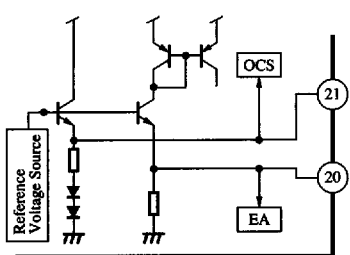
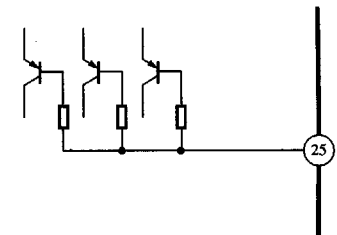
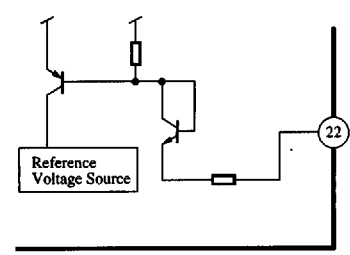
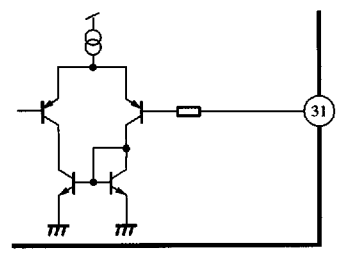
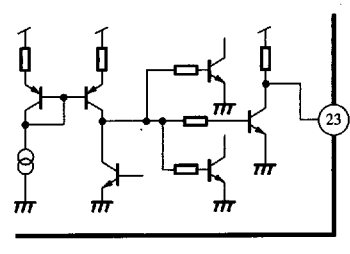
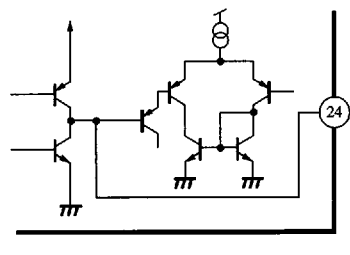
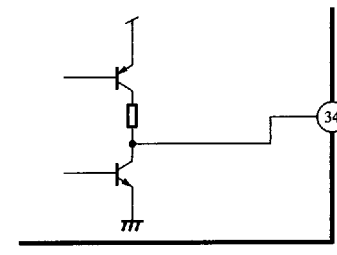
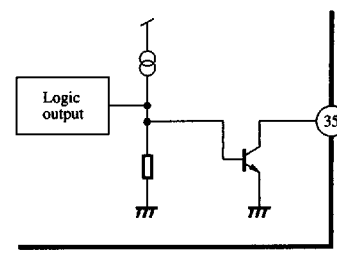
Pin No.	Symbol	Internal circuit	Pin No.	Symbol	Internal circuit
20	VTE1		25	COM	
21	VTE2		26~30	SG	Signal GND
22	S/S		31	W1	
23	OSC1		32	V1	Same as for Pin 31
			33	U1	Same as for Pin 31
24	OSC2		34	FG	
			35	SDO	

6932852 0012862 103

Internal Circuits (cont.)

Pin No.	Symbol	Internal circuit	Pin No.	Symbol	Internal circuit
36	NC				
37	CLK		42	EIC	
38	FR		43	SDE	
39	BR		44	SDI	
40	V _{CC}	V _{CC} Power Supply			
41	CS				

ICs for Motor

■ Block Diagram

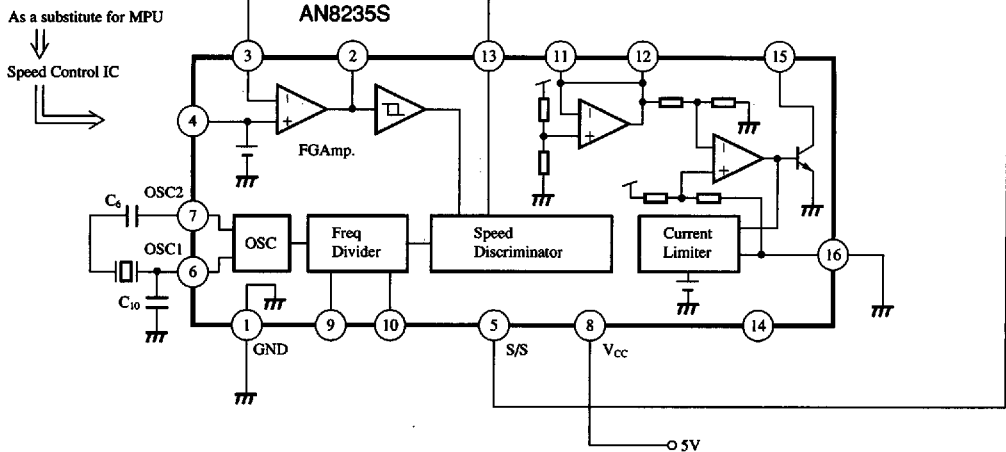
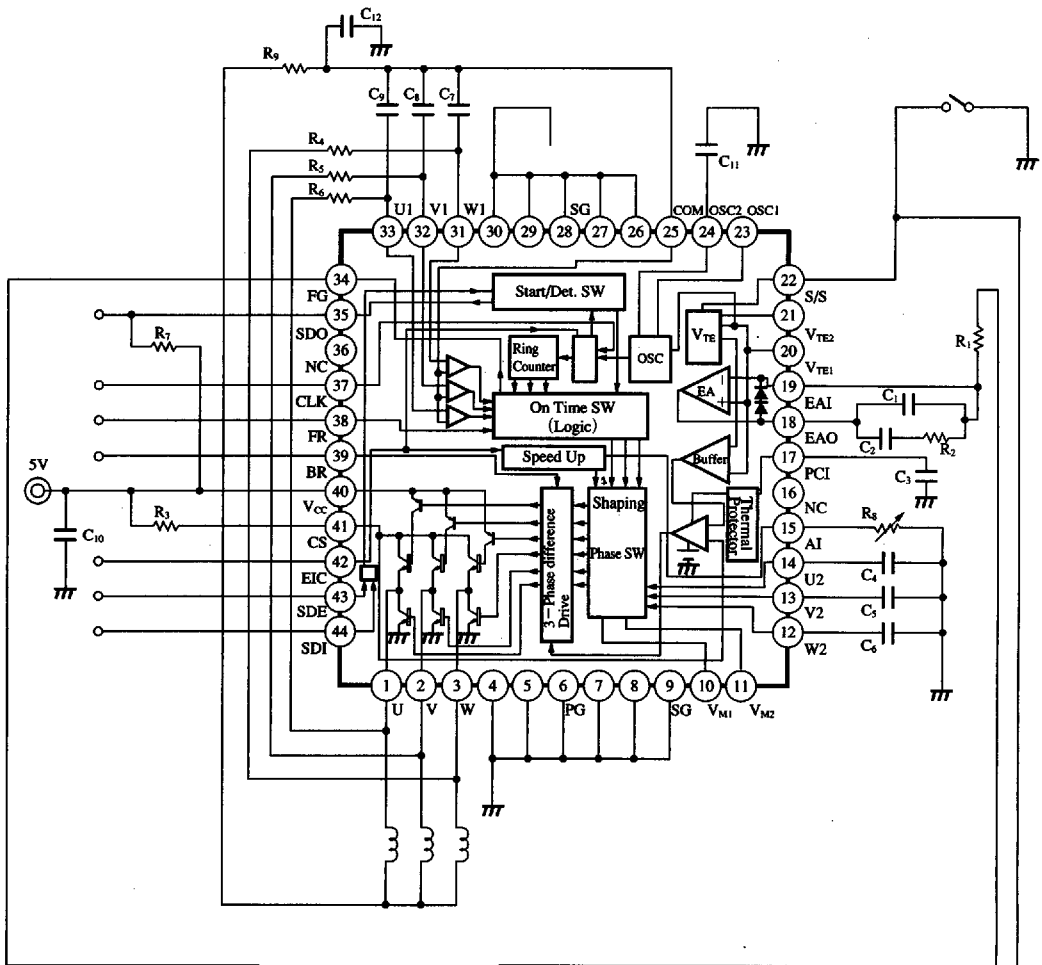

■ 6932852 0012864 T86 ■

External Parts Table

AN8221 (Sensor-less driver IC)		
External parts No.	Recommended value	Function
R ₁ , R ₂	C ₁ , C ₂	Constant of integration
	C ₃	For phase compensation
	C ₄ ~C ₆	For waveform shaping
R ₃		For current detection
R ₄ ~R ₆		Functions also as BEMF detection
	C ₇ ~C ₉	For noise reject filter
	C ₁₀	For protection from power supply noise
R ₇		For SDO detection
	C ₁₁	For triangular wave oscillation
R ₈		For regulation of waveform shaping speed

AN8235S (Speed control IC)		
External parts No.	Recommended value	Function
	C ₆ , C ₁₀	OSC/AC joint

(External Part Description)

1. Constant of integration (R₁, R₂, C₁ and C₂)

Refer to the data sheet for speed control IC.

2. For phase compensation (C₃)

It is a capacitor for phase compensation (low-pass filter) of the current feedback system.

3. For waveform shaping (C₄, C₅ and C₆)

They have a certain relationship with pole number of three-phase motor as a constant setting function.

Ex) When the motor with 12 poles is used,

$$Q = CV = it \cdots \begin{cases} C : \text{Capacitance of } C_4, C_5 \text{ and } C_6 \\ V : \text{DC voltage (200mV to 400mV)} \\ i : \text{Constant current (10 } \mu\text{A)} \\ t : \text{The cycle of FG (Three-phase pole)} \times 1/6 \end{cases}$$

The FG frequency under 3600 rpm of the three-phase 12 poles motor :

$$FG = \frac{3600\text{rpm}}{60\text{s}} \times \frac{12\text{poles}}{2} = 360\text{Hz}$$

$$T = \frac{1}{360\text{Hz}} \cong 2.78\text{ms}$$

$$t = \frac{1}{6} \times T \cong 463 \mu\text{s}$$

$$Q = it = 10 \mu\text{A} \times 463 \mu\text{sec} \cong 4.63 \times 10^{-9} [\text{q}]$$

Setting V=210mV (approx.)

$$C = \frac{it}{V} = \frac{4.63 \times 10^{-9}}{210 \times 10^{-3}} \cong 0.022 \mu\text{F}$$

When three-phase 12 poles motor is used, the capacitance of C4, C5 and C6 is set to 0.022 μ F.

When 4, 6 or 8 poles motor is used, the constant should be reviewed according to the above values.

4. For current detection (R3)

Resistor R3 has double function : detection resistor for the current flowing in the motor, as current feedback system ; and current limiter.

The voltage of current limiter is set to approx. 0.4V.

$$I_{\theta \max} = 0.4V/R3 \text{ [A]}$$

From the above calculation, the maximum current flowing in the motor can be set.

5. BEMF detection/noise rejection filter (R4, R5, R6, C7, C8 and C9)

It is a filter which rejects noise such as of inductive voltage generated from the motor. It is not required for the small noise motor.

When the filter constant is set too large, the optimum energization timing is missed, and the current value during constant rotation of motor is increased. Therefore, it should be set, taking into consideration the relationship with the motor.

For our motor, the following filter is used : R=10k Ω , C=0.012 μ F (approx.)

6. For power supply noise protection (C10)

When noise from the power supply makes the operation unstabilized, it should be attached.

7. For SDO detection (R7)

It outputs the start/detection loop switching output with the open collector.

8. For triangular wave oscillation (C11)

It is a capacitor for triangular wave oscillation. The oscillation frequency of triangular wave can be set as follows :

$$f_{osc2} = \frac{5}{8} \cdot \frac{1}{C11} \cdot \frac{1}{VTE2} \cdot ICH \cdot K \text{ [Hz]}$$

- C11 : External capacitor
- VTE2 : Reference voltage inside IC (approx. 2.5V)
- ICH : Reference current inside IC (approx. 3.3 μ A)
- K : Dispersion factor

9. For waveform shaping speed regulation (R8)

With resistor R8, the constant current of the waveform shaping block in external clock mode can be regulated.

10. OSC/AC joint

Refer to the data sheet for speed control IC (AN8235S).