

THE DRAWING ON THIS PRINT AND INFORMATION THEREWITH ARE PROPRIETARY TO VARITRONIX AND SHALL NOT BE USED IN WHOLE OR IN PART WITHOUT WRITTEN PERMISSION OF VARITRONIX.

PRELIMINARY

ISSUE	AMENDMENT	DATE

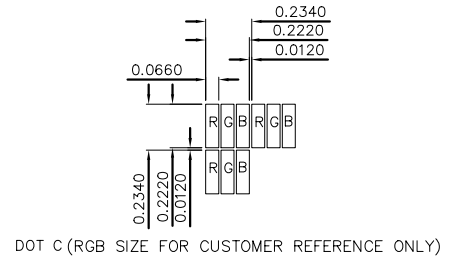
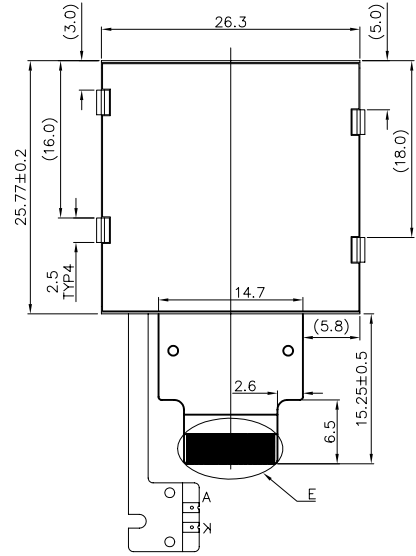
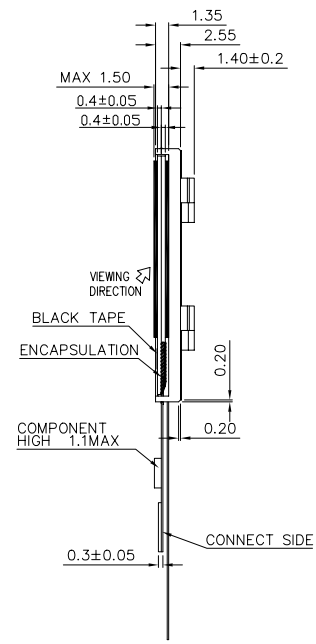
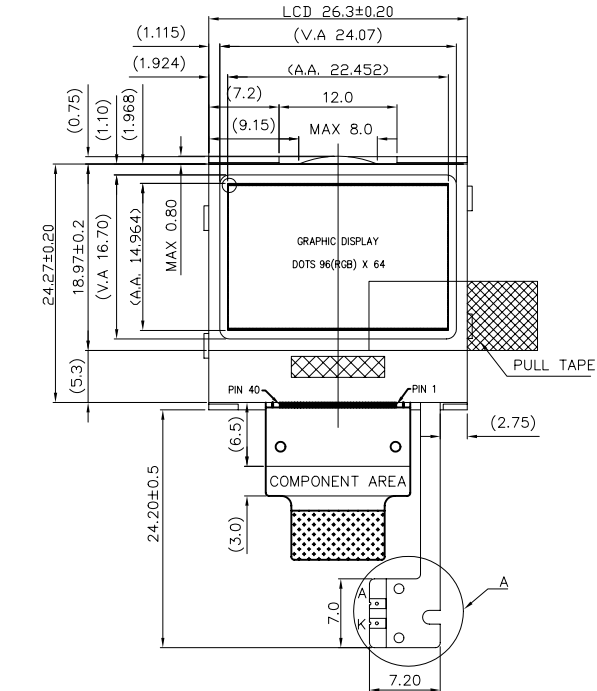

DISPLAY TYPE	65K CSTN TRANSMISSIVE
DISPLAY RESOLUTION	96(RGB) X 64
VIEWING ANGLE	6 O' CLOCK
MUX RATIO AND BIAS LEVEL	1/68 DUTY , 1/9 BIAS
LCD CONTROLLER/DRIVER	NT7528
LOGIC VOLTAGE	T.B.D
LCD DRIVING VOLTAGE	T.B.D
OPERATION TEMPERATURE	-20°C to +70°C
STORAGE TEMPERATURE	-30°C to +80°C
REMARK:	BACKLIGHT IS NOT TOOLED YET

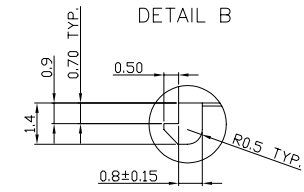
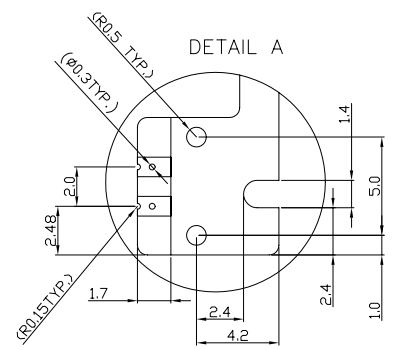
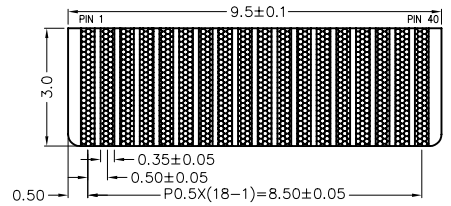
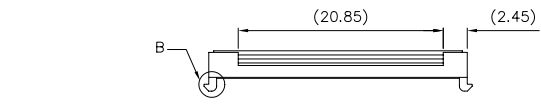

1	2	3	4	5	6	7	8	9	10	11	12	13	14	15	16	17	18
VOUT	VSS	VDD2	VDD	A0	/RES	/CS	D7	D6	D5	D4	D3	D2	D1	D0	/RD	/WR	GND

NOTES:
 1 ◊ : SPECIAL CHARACTERISTIC
 2 + : SAFETY CHARACTERISTIC
 3 ▽ : CRITICAL DIMENSION
 4 () : REFERENCE DIMENSION

VARITRONIX LIMITED

TITLE: LCM Module Specification		
PROJECT NO: COG-C100MVC-01		
CUSTOMER REF:		
TOLERANCE UNLESS OTHERWISE SPECIFIED:	X.X ±0.3	
	X.XX ±0.1	
DIMENSIONS IN MM	ANGULAR: ± 1°	
MATERIAL: N/A	FINISH: N/A	
SCALE: DO NOT ON SCALE	OVERALL THK: N/A	
THIRD ANGLE PROJECTION		
DRAWN:	NAME	DATE
HENRY HE		06.02.13
CHECKED:	SIGN	
LI YUN FEI		
APPROVED:		
ALFERD CHAN		
ITEM NO.: COG-C100MVC-01		
DESCRIPTION: COG-C100MVC-01		
FILE NO: COG COG-C100MVC-01	REV: 0	
SHEET	OF	
1	1	