

AN6500, AN6500S, AN6501

Built-in Reference Voltage Operational Amplifiers

Overview

The AN6500, the AN6500S, and the AN6501 are high-performance operational amplifiers with reference voltage built-in, allowing single power supply voltage operation and wide application with reference voltage.

Features

- Wide range of operating voltage : 3 to 24V
- Single power supply voltage operation
- Large output current : $I_{O} = +120\text{mA typ.}$
 -110mA typ.
- Low reference voltage : $V_{REF} = 1.33\text{V typ.}$
- Easy to compose variable regulator with reference voltage
- 3 types of packages are available
- Little cross-over distortion in operational amplifier circuit

Schematic Diagram

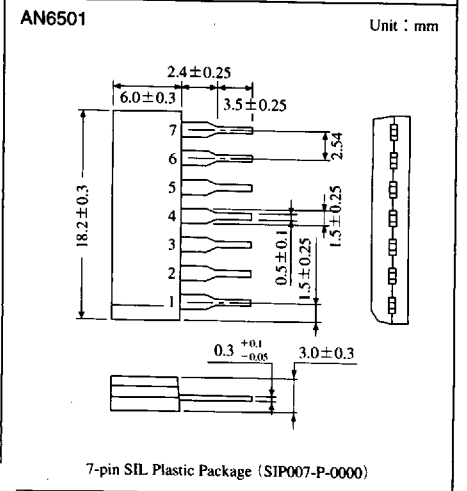
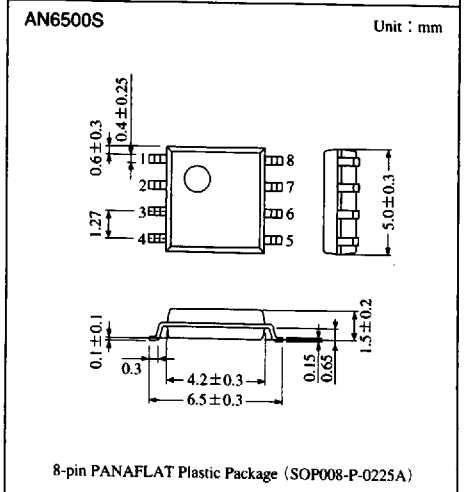
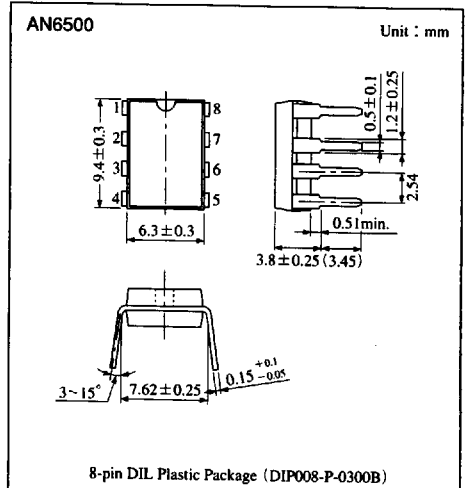
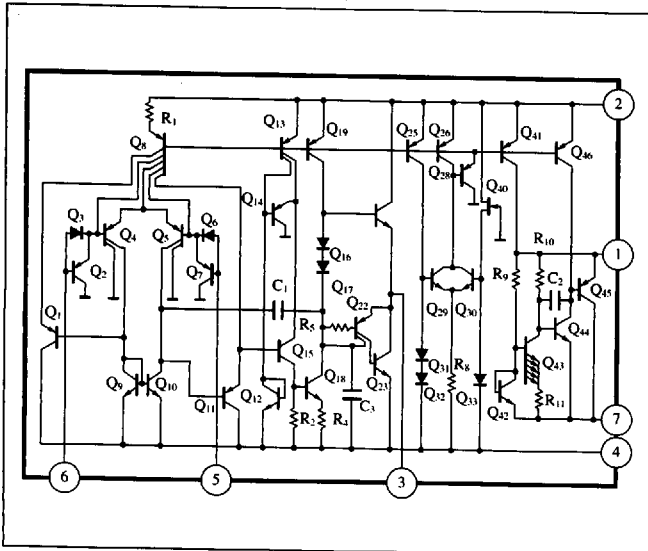

6932852 0012399 790

■ Pin Descriptions

Pin No.	Pin name
1	Ref. voltage (+)
2	Supply voltage
3	OP. amp. output
4	GND
5	OP. amp. input (+)
6	OP. amp. input (-)
7	Ref. voltage (-)
8	NC

■ Absolute Maximum Ratings (Ta = 25°C)

Parameter		Symbol	Rating	Unit
Supply voltage		V _{CC}	24	V
Supply current		I _{CC}	160	mA
Reference voltage outflow current		(V _{REF}) - I ^{*1}	-100	μA
Reference voltage inflow current		(V _{REF}) + I ^{*2}	500	μA
Common-mode input voltage range		V _{ICM}	-0.3 to +24	V
Differential input voltage		V _{ID}	24	V
Output sink current		V _{SINK}	150	mA
Power dissipation	AN6500	P _D ^{*3}	750	mW
	AN6500S		360	mW
	AN6501		925	mW
Operating ambient temperature		T _{opr}	-20 to +75	°C
Storage temperature	AN6500, AN6501	T _{stg}	-55 to +150	°C
	AN6500S		-40 to +125	°C

*1 Current flowed out from Pin①. *2 Current flowed into Pin①. *3 When enlarging output current, watch power consumption.

■ Electrical Characteristics (V_{CC} = 5V, Ta = 25°C ± 2°C)

Parameter	Symbol	Condition	min	typ	max	Unit
Reference voltage	V _{REF}		1.25	1.33	1.45	V
Reference voltage temperature variation characteristics	ΔV _{REF} /Ta	Ta = 0 to 50°C	—	-30	—	ppm/°C
Input offset voltage	V _{I(offset)}	R _S = 50Ω	—	2	7	mV
Input bias current	I _{Bias}		—	100	500	nA
Input offset current	I _{IO}		—	5	300	nA
Common-mode input voltage range	V _{CM}		—	—	3.5	V
Supply current	I _{CC}	R _L = ∞	—	2.5	3.5	mA
Voltage gain	G _V	R _L ≥ 2kΩ	80	108	—	dB
Maximum output voltage (1)	V _{O(max)1}	R _L ≥ 2kΩ	3.5	—	—	V
Maximum output voltage (2)	V _{O(max)2}	V _{CC} = 5V, I _O = 70mA	3	4.1	—	V
Common-mode rejection ratio	CMR		—	85	—	dB
Supply voltage rejection ratio	SVR		—	90	—	dB
Output source current	I _{O(source)}	V _{IN} ⁺ = 1V, V _{IN} ⁻ = 0V	70	110	—	mA
Output sink current	I _{SINK}	V _{IN} ⁺ = 0V, V _{IN} ⁻ = 1V	70	120	—	mA
Zero-cross frequency	f _(T)		—	1	—	MHz

■ 6932852 0012400 232 ■

■ Characteristics Curve

$P_D - T_a$

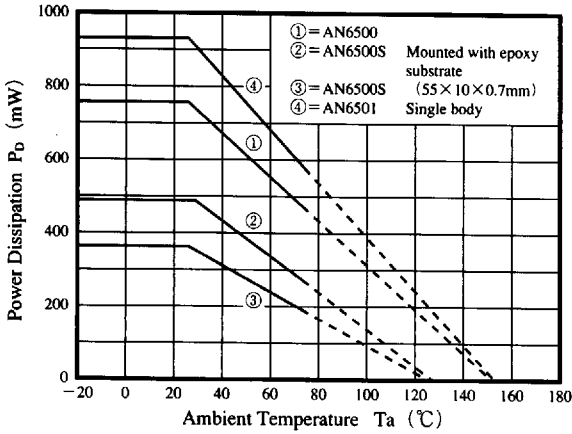

$I_{CC} - V_{CC}$

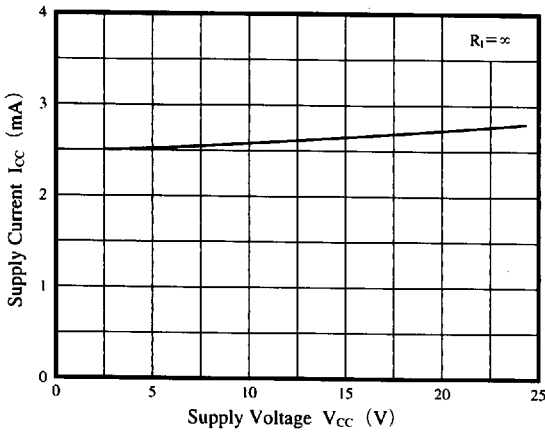

$V_{REF} - V_{CC}$

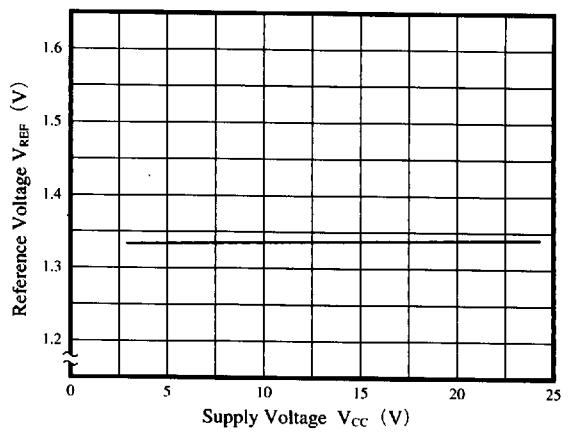

$V_{REF} - (V_{REF}) + I$

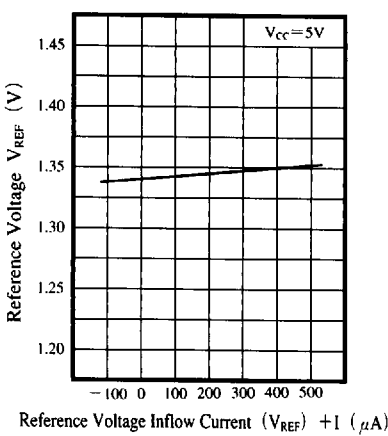

$G_V - f$

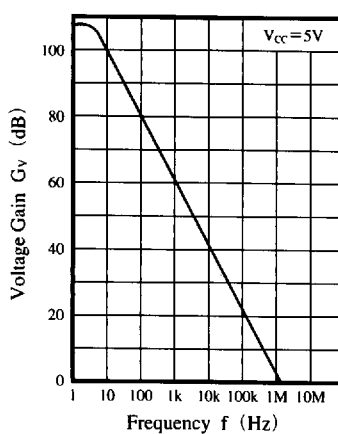

$I_{CC} - T_a$

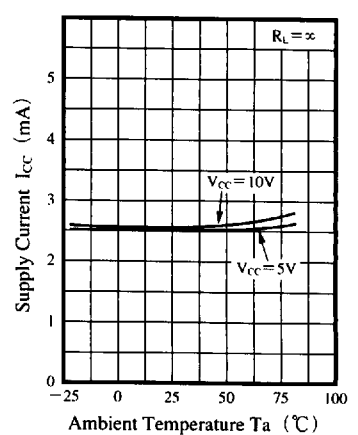

■ 6932852 0012401 179 ■

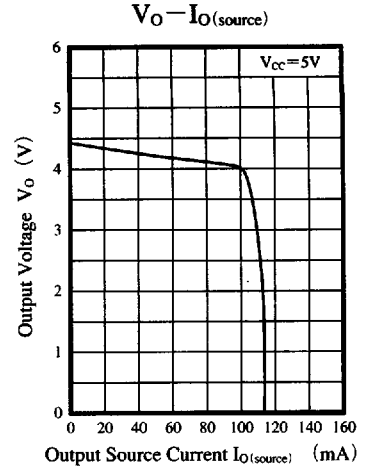
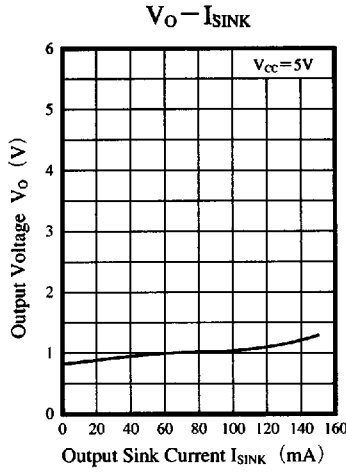
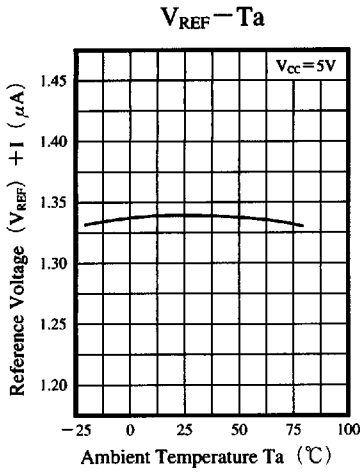

Application Circuits

1. Voltage Regulator Circuit

High efficiency circuit with small I/O voltage difference

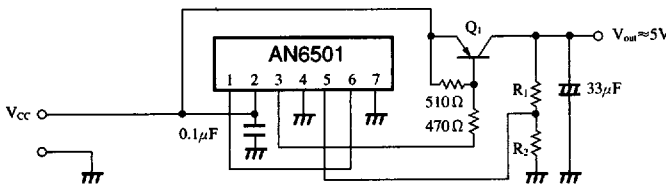

• Output voltage (V_{out}) is calculated by the following formula.

$$V_{out} = \frac{R_1 + R_2}{R_2} V_{REF}$$

$$= \frac{R_1 + R_2}{R_2} \times 1.33 \text{ (V)}$$

• I/O Voltage difference

2SB896 is applied for Q_1 when output current is 330mA. The minimum I/O voltage difference is 0.2V.

Parameter	Symbol	Condition	typ	Unit
Line regulation	REG _{IN}	$V_{CC}=6 \text{ to } 20\text{V}, I_O=1\text{A}$	16	mV
Load regulation	REG _L	$V_{CC}=10\text{V}, I_O=5\text{mA to } 1\text{A}$	9	mV
Ripple rejection ratio	RR	$V_{CC}=8 \text{ to } 18\text{V}, I_O=100\text{mA}, f=120\text{Hz}$	57.4	dB

2. Voltage Regulator Circuit

With output current limiter

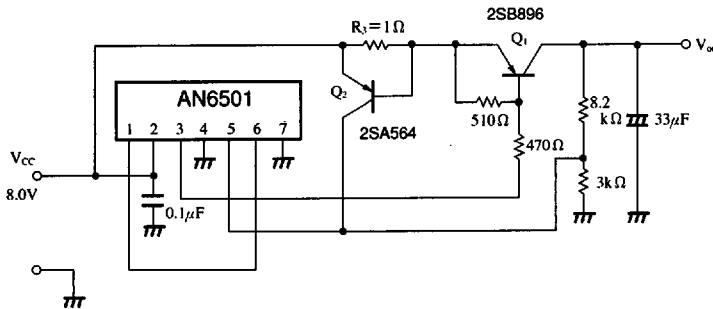

• Limit Current $I_{O(Lim)}$ is calculated by the following formula

$$I_{O(Lim)} = \frac{V_{BE}(Q_2)}{R_3}$$

When $V_{BE}(Q_2) = 0.7\text{V}$, and $R_3 = 1\Omega$,

$$I_{O(Lim)} = \frac{0.7}{1} = 0.7\text{A}$$

6932852 0012402 005