

## High Dynamic Range Low Noise Amplifier 1400 - 2000 MHz

**AM50-0004  
V6**

### Features

- Low Noise Figure: 1.4 dB
- High Input IP3: +18 dBm at 8 V, 45 mA bias  
+8 dBm at 3 V, 20 mA bias
- High Gain: 14 dB
- Single Supply: +3 to +8 VDC
- Low Cost SOIC-8 Plastic Package
- Adjustable current: 20 to 60 mA with external resistor

### Description

M/A-COM's AM50-0004 is a high dynamic range, GaAs MMIC, low noise amplifier in a low cost, SOIC 8-lead, surface mount, plastic package. It employs external input matching to obtain optimum noise figure performance and operating frequency flexibility. The AM50-0004 also features flexible biasing to control the current consumption vs. dynamic range trade-off. The AM50-0004 can operate from any positive supply voltage in the 3 V to 8 V range. Its current can be controlled over a range of 20 mA to 60 mA with an external resistor.

The AM50-0004 is ideally suited for use where low noise figure, high gain, high dynamic range, and low power consumption are required. Typical applications included receiver front ends in PDC, DCS-1800, DCS-1900 and other PCN/PCS base stations. It is also useful as a gain block, buffer, driver, and IF amplifier in both fixed or portable PDC and PCN/PCS systems.

The AM50-0004 is fabricated using a low-cost 0.5-micron gate length GaAs process. The process features full passivation for increased performance and reliability. The AM50-0004 is 100% RF tested to ensure performance specification compliance.

### Ordering Information

Part Number	Package
AM50-0004	Bulk Packaging
AM50-0004TR	1000 piece reel
AM50-0004SMB	Designer's Kit

Note: Reference Application Note M513 for reel size information.

### Functional Block Diagram

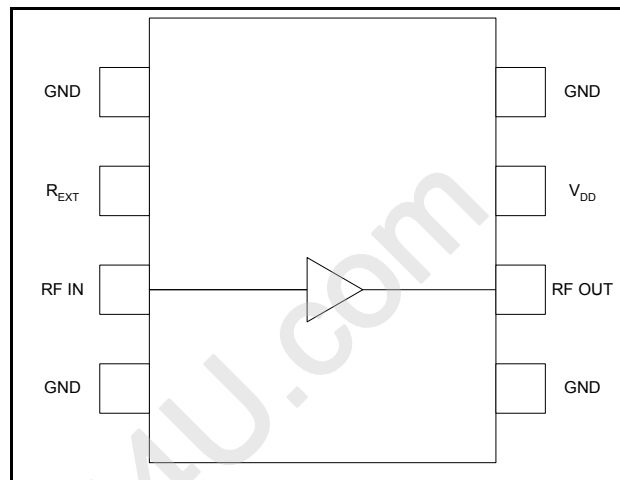

### Pin Configuration

Pin No.	Pin Name	Description
1	GND	RF and DC Ground
2	R <sub>EXT</sub>	External Current Control (optional)
3	RF IN	RF Input of the amplifier
4	GND	RF and DC Ground
5	GND	RF and DC Ground
6	RF OUT	RF Output of the amplifier
7	V <sub>DD</sub>	Positive supply voltage
8	GND	RF and DC Ground

### Absolute Maximum Ratings <sup>1,2</sup>

Parameter	Absolute Maximum
V <sub>DD</sub>	+10 VDC
Input Power	+17 dBm
Current <sup>3</sup>	80 mA
Channel Temperature <sup>4</sup>	+150°C
Operating Temperature	-40°C to +85°C
Storage Temperature	-65°C to +150°C

1. Exceeding any one or combination of these limits may cause permanent damage.
2. M/A-COM does not recommend sustained operation near these survivability limits.
3. When pin #2 is used to increase current. (See note 7.)
4. Thermal resistance (θ<sub>jc</sub>) = +99°C/W.

- **North America** Tel: 800.366.2266 / Fax: 978.366.2266
- **Europe** Tel: 44.1908.574.200 / Fax: 44.1908.574.300
- **Asia/Pacific** Tel: 81.44.844.8296 / Fax: 81.44.844.8298

Visit [www.macom.com](http://www.macom.com) for additional data sheets and product information.

**High Dynamic Range Low Noise Amplifier  
1400 - 2000 MHz**

**AM50-0004  
V6**

**Electrical Specifications:  $T_A = +25^\circ\text{C}$ ,  $Z_0 = 50\ \Omega$ ,  $F = 1785\ \text{MHz}$ ,  $P_{in} = -30\ \text{dBm}$**

Parameter	Test Conditions	Units	Min.	Typ.	Max.
Gain	5 V, 45 mA <sup>5</sup>	dB	12.0	14	—
	3 V, 20 mA	dB	—	12.5	—
Noise Figure	5 V, 45 mA <sup>5</sup>	dB	—	1.4	1.8
	3 V, 20 mA	dB	—	1.5	—
Input VSWR	—	Ratio	—	1.5:1	—
Output VSWR	—	Ratio	—	2.0:1	—
Output 1 dB Compression	5 V, 45 mA <sup>5</sup>	dBm	—	16.0	—
	3 V, 20 mA	dBm	—	9.0	—
Input IP3	5 V, 45 mA <sup>5</sup>	dBm	13.0	15	—
	3 V, 20 mA	dBm	—	8.0	—
Reverse Isolation	—	dB	—	22	—
Drain Current	5 V, 45 mA <sup>5</sup>	mA	30	45	60

5. Using external 15  $\Omega$  resistor. See functional schematic below.

**Functional Schematic**

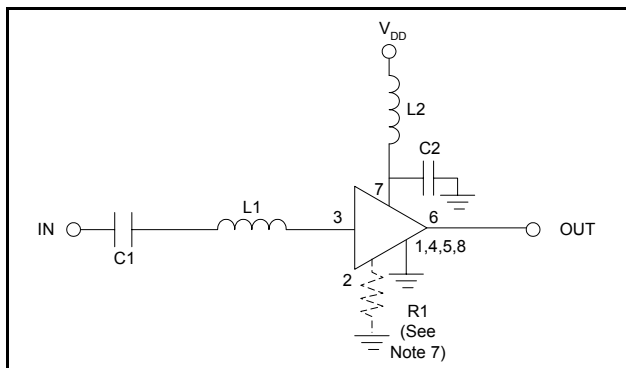

**Handling Procedures**

Please observe the following precautions to avoid damage:

**Static Sensitivity**

Gallium Arsenide Integrated Circuits are sensitive to electrostatic discharge (ESD) and can be damaged by static electricity. Proper ESD control techniques should be used when handling these devices.

**External Components List <sup>6</sup>**

Part	Value	Case Size	Manufacturer	Purpose
C1	47 pF	0603	Murata	DC Block
C2	47 pF	0603	Murata	By-Pass
L1	3.9 nH	0603	Coilcraft	Tuning
L2	12 nH	0603	Coilcraft	RF Choke
R1	see note 7	0603	Panasonic	Optional current control

6. All external circuitry parts are readily available, low cost surface mount components (.060 in. x .030 in. or .080 in. x .050 in.).
7. Pin 2 allows use of an external resistor to ground for optional, higher current. For 20 mA operation, no resistor is used.  
 For  $I_{DD} \sim 30\ \text{mA}$ ,  $R1 = 39\ \text{ohms}$ ;  
 $I_{DD} \sim 45\ \text{mA}$ ,  $R1 = 15\ \text{ohms}$ ;  
 $I_{DD} \sim 60\ \text{mA}$ ,  $R1 = 6\ \text{ohms}$ .

**High Dynamic Range Low Noise Amplifier  
1400 - 2000 MHz**

**AM50-0004  
V6**

**Recommended PCB Configuration**

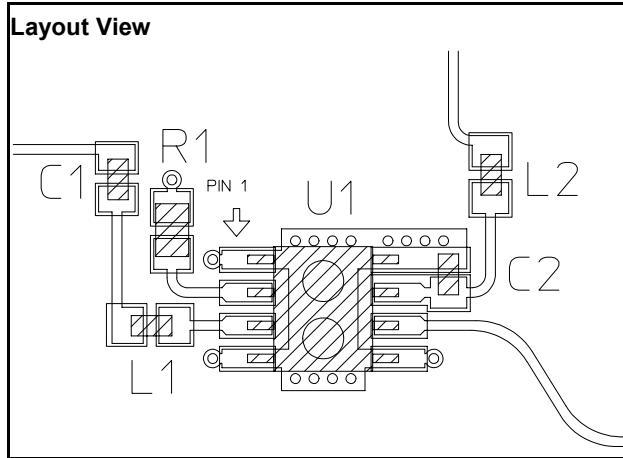

**Cross Section View**

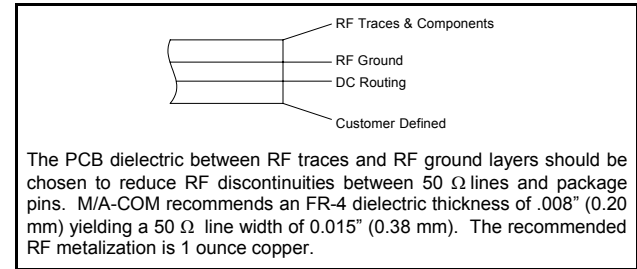

**Designer's Kit AM50-0004SMB**

The AM50-0004SMB Designer's Kit allows for immediate evaluation of M/A-COM's AM50-0004. The Designer's Kit includes an AM50-0004 mounted on an evaluation board and five loose AM50-0004's. The evaluation board consists of the recommended external surface mount circuitry, RF connectors, and a DC multi-pin connector, all mounted to a multi-layer FR-4 PCB. The AM50-0004SMB evaluation PCB is illustrated below with all functional ports labeled.

**AM50-0004 Evaluation Board**

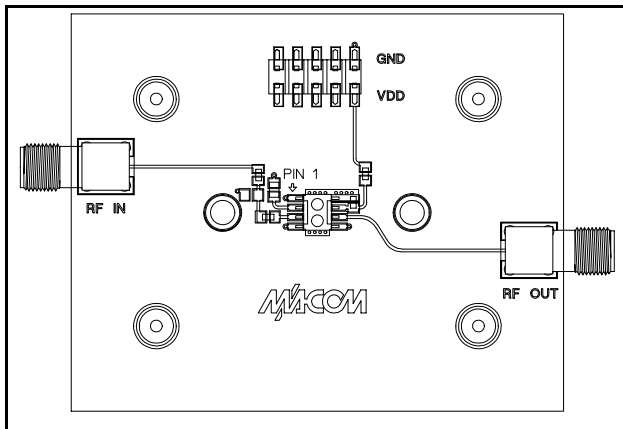

**Evaluation PCB & RF Connector Losses**

Port Reference	Approximate RF Loss
RF In	0.15 dB @ 1785 MHz
RF Out	0.15 dB @ 1785 MHz

The DC connector on the Designer's Kit PCB allows convenient DC line access. This is accomplished by the one or more of the following methods.

1. A mating female multi-pin connector (Newark Electronics Stock # 46F-4658, not included).
2. Wires soldered to the necessary pins (not included).
3. Clip leads (not included).

**High Dynamic Range Low Noise Amplifier  
1400 - 2000 MHz**

**AM50-0004  
V6**

**Typical Performance Curves**

**Test Conditions:  $T_A = +25^\circ\text{C}$ ,  $Z_0 = 50 \Omega$ ,  $V_{DD} = 5 \text{ V}$ ,  $I_{DD} = 45 \text{ mA}$  unless otherwise specified.**

**Gain vs. Frequency**

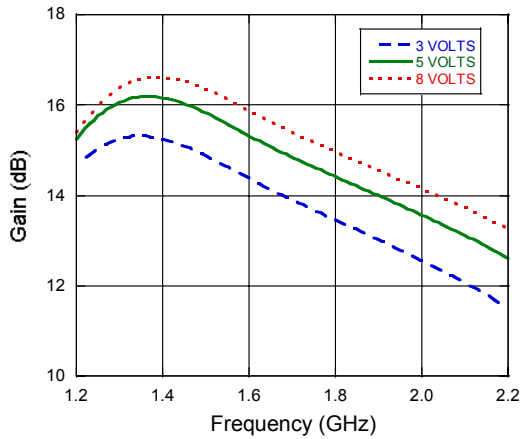

**VSWR vs. Frequency**

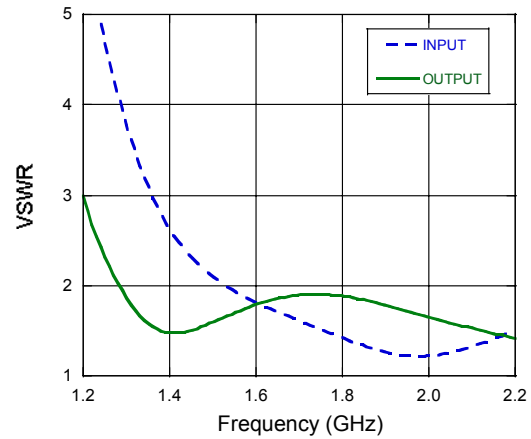

**Noise Figure vs. Frequency**

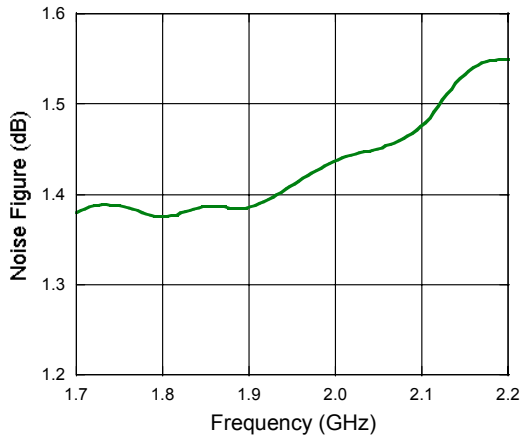

**Noise Figure vs. Current,  $F = 1785 \text{ MHz}$**

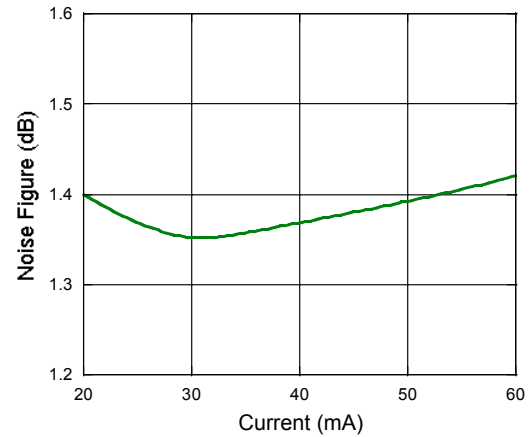

**Output P1 dB vs. Frequency**

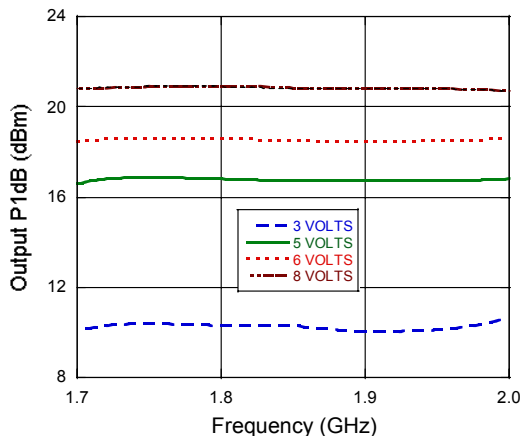

**Output P1 dB vs. Current,  $F = 1785 \text{ MHz}$**

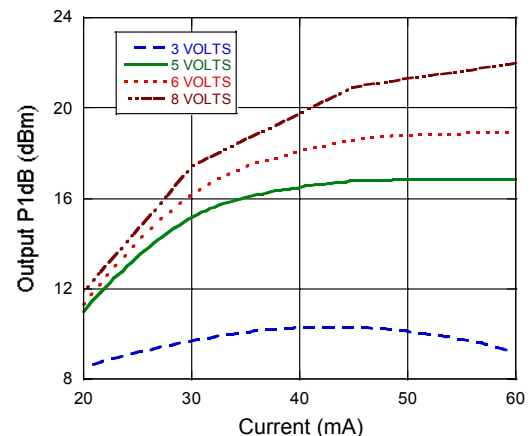

**High Dynamic Range Low Noise Amplifier  
1400 - 2000 MHz**

**AM50-0004  
V6**

**Typical Performance Curves**

**Test Conditions:  $T_A = +25^\circ\text{C}$ ,  $Z_0 = 50 \Omega$ ,  $V_{DD} = 5 \text{ V}$ ,  $I_{DD} = 45 \text{ mA}$  unless otherwise specified.**

**Input IP3 vs. Frequency**

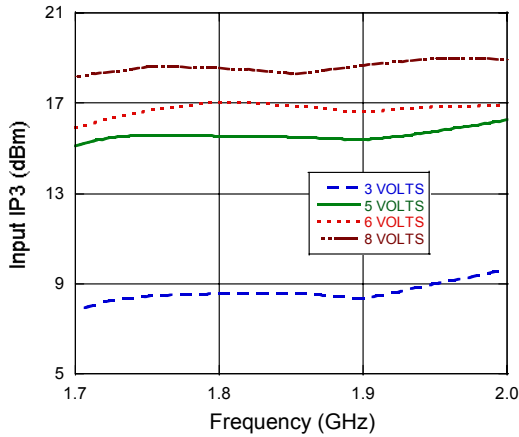

**Input IP3 vs. Current,  $F = 1785 \text{ MHz}$**

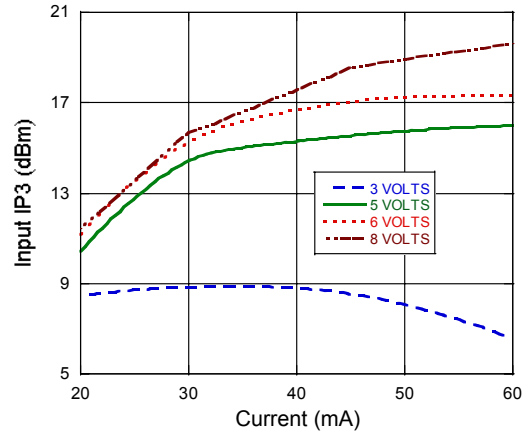

**Gain vs. Temperature**

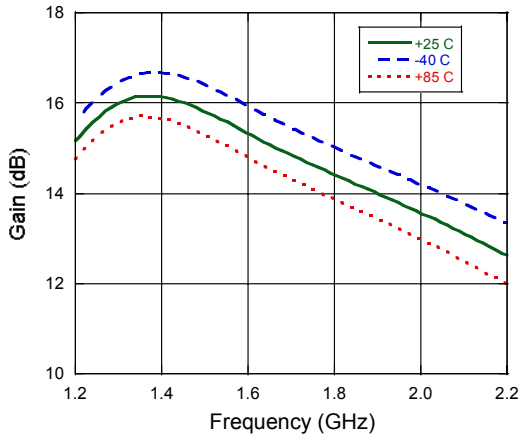

**Noise Figure vs. Temperature**

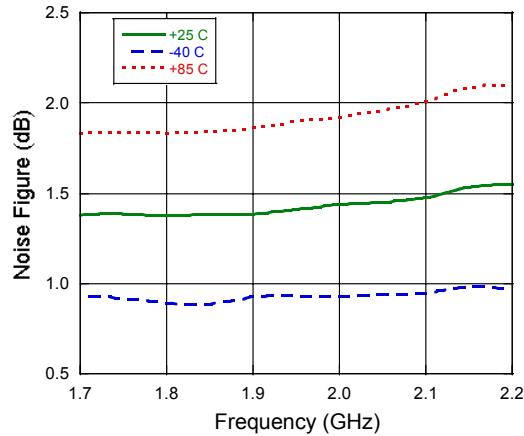

**SOIC-8**

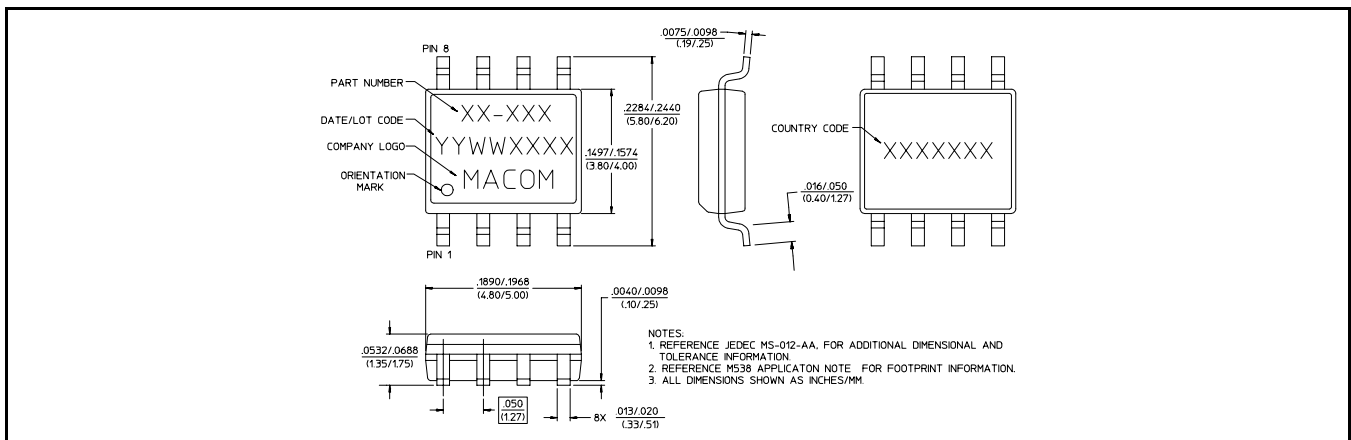

5

M/A-COM Inc. and its affiliates reserve the right to make changes to the product(s) or information contained herein without notice. M/A-COM makes no warranty, representation or guarantee regarding the suitability of its products for any particular purpose, nor does M/A-COM assume any liability whatsoever arising out of the use or application of any product(s) or information.

- **North America** Tel: 800.366.2266 / Fax: 978.366.2266
- **Europe** Tel: 44.1908.574.200 / Fax: 44.1908.574.300
- **Asia/Pacific** Tel: 81.44.844.8296 / Fax: 81.44.844.8298

Visit [www.macom.com](http://www.macom.com) for additional data sheets and product information.