

SANYO

No. 4742

LC72P32**One-Time Programmable ROM Single-Chip
PLL Plus Microcontroller****Overview**

The LC72P32 is a version of the LC7232N single-chip PLL plus microcontroller product that provides an 8 Kbyte (4096 words × 16 bits) one-time programmable ROM on chip. The LC72P32 has identical functions and the same pin assignment and packaging as the LC7232N, which is a mask ROM product. The LC72P32 can contribute to bringing up the first production run of a new product quickly and to reducing the switchover period when specifications change.

Features

- Option selection according to PROM data
The LC7232N optional functions can be specified with PROM data. This allows mass-production products to be tested and evaluated.
- On-chip 8 Kbyte (4096 words × 16 bits) PROM
This is a one-time programmable 8 Kbyte (4096 words × 16 bits) ROM.
- Packaging and pin assignments are identical to those of the LC7232N mask ROM version, i.e., these products are pin compatible.

Sanyo PROM Writing Service

Sanyo provides custom PROM writing, printing, screening and read-back testing (for fee) services for our one-time programmable ROM microcontroller products. Contact your Sanyo sales representative for pricing and other details.

Package Dimensions

unit: mm

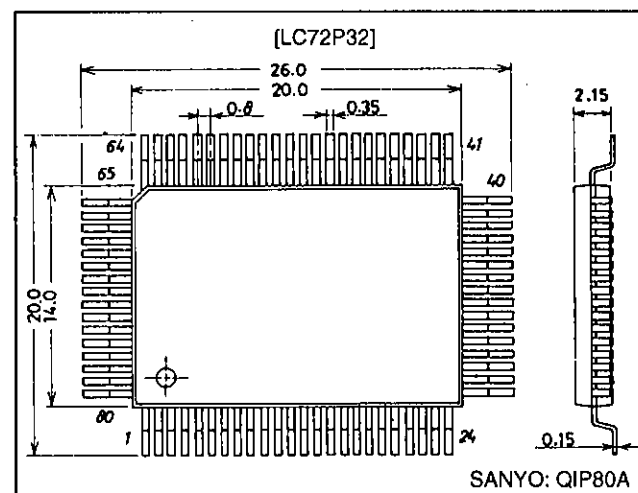
3044B-QIP80A**Specifications****Absolute Maximum Ratings at $T_a = 25^\circ\text{C}$, $V_{SS} = 0\text{ V}$**

Parameter	Symbol	Conditions	Ratings	Unit
Maximum supply voltage	$V_{DD\text{ max}}$		-0.3 to +6.5	V
Input voltage	V_{IN1}	HOLD, INT, RES, ADI, SNS, and the G port	-0.3 to +13	V
	V_{IN2}	Inputs other than V_{IN1}	-0.3 to $V_{DD} + 0.3$	V
Output voltage	V_{OUT1}	H port	-0.3 to +15	V
	V_{OUT2}	Outputs other than V_{OUT1}	-0.3 to $V_{DD} + 0.3$	V
Output current	I_{OUT1}	D and H port pins	0 to 5	mA
	I_{OUT2}	E and F port pins	0 to 3	mA
	I_{OUT3}	B and C port pins	0 to 1	mA
	I_{OUT4}	S1 to S28 and I port pins	0 to 1	mA
Allowable power dissipation	$P_{d\text{ max}}$	$T_{opg} = -30$ to $+70^\circ\text{C}$	400	mW
Operating temperature	T_{opr}		-30 to +70	$^\circ\text{C}$
Storage temperature	T_{stg}		-45 to +125	$^\circ\text{C}$

Note: This IC has reduced resistance to damage from static discharges and therefore requires special care in handling.

SANYO Electric Co., Ltd. Semiconductor Business Headquarters

TOKYO OFFICE Tokyo Bldg., 1-10, 1 Chome, Ueno, Taito-ku, TOKYO, 110 JAPAN

LC72P32

Allowable Operating Ranges at $T_a = -30$ to $+70^\circ\text{C}$, $V_{DD} = 4.0$ to 5.5 V

Parameter	Symbol	Conditions	min	typ	max	Unit
Supply voltage	V_{DD1}	CPU and PLL operating	4.5		5.5	V
	V_{DD2}	CPU operating	4.0		5.5	V
	V_{DD3}	Memory hold	1.3		5.5	V
Input high level voltage	V_{IH1}	G port	$0.7 V_{DD}$		8.0	V
	V_{IH2}	RES, INT, HOLD	$0.8 V_{DD}$		8.0	V
	V_{IH3}	SNS	2.5		8.0	V
	V_{IH4}	A port	$0.6 V_{DD}$		V_{DD}	V
	V_{IH5}	E and F ports	$0.7 V_{DD}$		V_{DD}	V
	V_{IH6}	LCTR (period measurement), V_{DD1}	$0.8 V_{DD}$		V_{DD}	V
Input low level voltage	V_{IL1}	G port	0		$0.3 V_{DD}$	V
	V_{IL2}	RES, INT	0		$0.2 V_{DD}$	V
	V_{IL3}	SNS	0		1.3	V
	V_{IL4}	A port	0		$0.2 V_{DD}$	V
	V_{IL5}	E and F port	0		$0.3 V_{DD}$	V
	V_{IL6}	LCTR (period measurement), V_{DD1}	0		$0.2 V_{DD}$	V
	V_{IL7}	HOLD	0		$0.4 V_{DD}$	V
Input frequency	f_{IN1}	XIN	4.0	4.5	5.0	MHz
	f_{IN2}	FMIN, V_{IN2} , V_{DD1}	10		130	MHz
	f_{IN3}	FMIN, V_{IN3} , V_{DD1}	10		150	MHz
	f_{IN4}	AMIN (L), V_{IN4} , V_{DD1}	0.5		10	MHz
	f_{IN5}	AMIN (H), V_{IN5} , V_{DD1}	2.0		40	MHz
	f_{IN6}	HCTR, V_{IN6} , V_{DD1}	0.4		12	MHz
	f_{IN7}	LCTR (frequency measurement), V_{IN7} and V_{DD1}	100		500	kHz
	f_{IN8}	LCTR (period), V_{IH6} , V_{IL6} and V_{DD1}	1		20×10^3	Hz
Input amplitude	V_{IN1}	XIN	0.50		1.5	Vrms
	V_{IN2}	FMIN	0.10		1.5	Vrms
	V_{IN3}	FMIN	0.15		1.5	Vrms
	$V_{IN4, 5}$	AMIN	0.10		1.5	Vrms
	$V_{IN6, 7}$	LCTR, HCTR	0.10		1.5	Vrms
Input voltage range	V_{IN8}	ADI	0		V_{DD}	V

LC72P32

Electrical Characteristics for the Allowable Operating Ranges

Parameter	Symbol	Conditions	min	typ	max	Unit
Hysteresis	V _H	LCTR (period), RES, INT	0.1 V _{DD}			V
Reject pulse width	P _{REJ}	SNS			50	μs
Power-down detection voltage	V _{DET}		3.0	3.5	4.0	V
Input high level current	I _{IH1}	HOLD, INT, RES, ADI, SNS, and the G port: V _I = 5.5 V			3.0	μA
	I _{IH2}	A, E and F ports: E and F ports output off, A port with no R _{PD} : V _I = V _{DD}			3.0	μA
	I _{IH3}	XIN: V _I = V _{DD} = 5.0 V	2.0	5.0	15	μA
	I _{IH4}	FMIN, AMIN, HCTR, LCTR: V _I = V _{DD} = 5.0 V	4.0	10	30	μA
	I _{IH5}	A port: with R _{PD} : V _I = V _{DD} = 5.0 V		50		μA
Input low level current	I _{IL1}	INT, HOLD, RES, ADI, SNS, and the G port: V _I = V _{SS}			3.0	μA
	I _{IL2}	A, E and F ports: E and F ports output off, A port with no R _{PD} : V _I = V _{SS}			3.0	μA
	I _{IL3}	XIN: V _{IN} = V _{SS}	2.0	5.0	15	μA
	I _{IL4}	FMIN, AMIN, HCTR, LCTR: V _I = V _{SS}	4.0	10	30	μA
Input floating voltage	V _{IF}	A port: with R _{PD}			0.05 V _{DD}	V
Pull-down resistance	R _{PD}	A port: with R _{PD} , V _{DD} = 5.0 V	75	100	200	kΩ
Output high level off leakage current	I _{OFFH1}	EO1, EO2: V _O = V _{DD}		0.01	10	nA
	I _{OFFH2}	B, C, D, E, F, and I ports: V _O = V _{DD}			3.0	μA
	I _{OFFH3}	H port: V _O = 13 V			5.0	μA
Output low level off leakage current	I _{OFFL1}	EO1, EO2: V _O = V _{SS}		0.01	10	nA
	I _{OFFL2}	B, C, D, E, F, and I ports: V _O = V _{SS}			3.0	μA
Output high level voltage	V _{OH1}	B and C ports: I _O = -1 mA	V _{DD} - 2.0	V _{DD} - 1.0	V _{DD} - 0.5	V
	V _{OH2}	E and F ports: I _O = -1 mA	V _{DD} - 1.0			V
	V _{OH3}	EO1, EO2: I _O = -500 μA	V _{DD} - 1.0			V
	V _{OH4}	XOUT: I _O = -200 μA	V _{DD} - 1.0			V
	V _{OH5}	S1 to S28 and I port: I _O = -0.1 mA	V _{DD} - 1.0			V
	V _{OH6}	D port: I _O = -5 mA	V _{DD} - 1.0			V
	V _{OH7}	COM1, COM2: I _O = -25 μA	V _{DD} - 0.75	V _{DD} - 0.5	V _{DD} - 0.3	V
Output low level voltage	V _{OL1}	B and C ports: I _O = 50 μA	0.5	1.0	2.0	V
	V _{OL2}	E and F ports: I _O = 1 mA			1.0	V
	V _{OL3}	EO1, EO2: I _O = 500 μA			1.0	V
	V _{OL4}	XOUT: I _O = 200 μA			1.0	V
	V _{OL5}	S1 to S28 and I port: I _O = 0.1 mA			1.0	V
	V _{OL6}	D port: I _O = 5 mA			1.0	V
	V _{OL7}	COM1, COM2: I _O = 25 μA	0.3	0.5	0.75	V
	V _{OL8}	H port: I _O = 5 mA	(150 Ω) 0.75		(400 Ω) 2.0	V
Output middle level voltage	V _{M1}	COM1, COM2: V _{DD} = 5.0 V, I _O = 20 μA	2.0	2.5	3.0	V
A/D conversion error		ADI, V _{DD1}	-1/2		1/2	LSB
Current drain	I _{DD1}	V _{DD1} , f _{IN2} = 130 MHz		15	20	mA
	I _{DD2}	V _{DD} = 5.0 V, PLL stopped, CT = 2.67 μs (HOLD mode, Figure 1)		2.7		mA
	I _{DD3}	V _{DD} = 5.0 V, PLL stopped, CT = 13.33 μs (HOLD mode, Figure 1)		1.7		mA
	I _{DD4}	V _{DD} = 5.0 V, PLL stopped, CT = 40.00 μs (HOLD mode, Figure 1)		1.5		mA
	I _{DD5}	V _{DD} = 5.5 V, oscillator stopped, Ta = 25°C (BACKUP mode, Figure 2)			5	μA
	V _{DD} = 2.5 V, oscillator stopped, Ta = 25°C (BACKUP mode, Figure 2)			1	μA	

Test Circuits

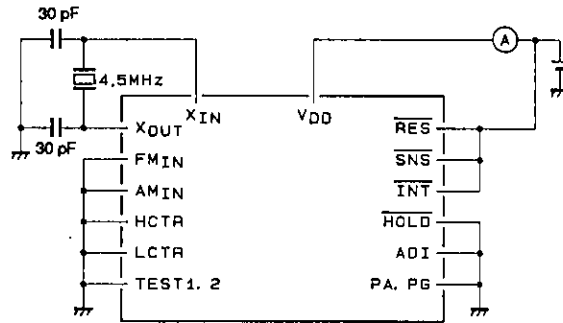

A01885

Note: With PB to PF, PH and PI all open. Note that output mode is selected for PE and PF.

Figure 1 I_{DD2} to I_{DD4} in HOLD Mode

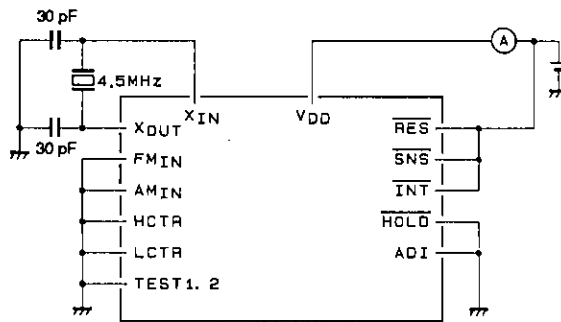

A01886

Note: With PA to PI, S1 to S24, COM1 and COM2 open.

Figure 2 I_{DD5} in BACKUP Mode

LC72P32

Pin Functions

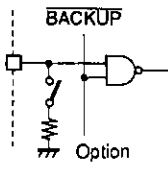
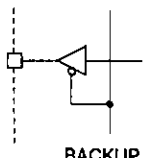
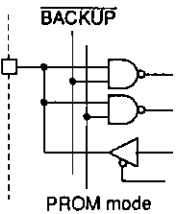
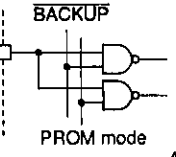
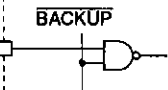
Pin	Pin No.	Function	I/O	Circuit type	PROM mode function
PA0 PA1 PA2 PA3	35 34 33 32	Low threshold type dedicated input port These pins can be used, for example, for key data acquisition. Built-in pull-down resistors can be specified as an option. This option is in 4-pin units, and cannot be specified for individual pins. Input through these pins is disabled in BACKUP mode.	Input	 <p style="text-align: right;">A01887</p>	
PB0 PB1 PB2 PB3 PC0 PC1 PC2 PC3	30 29 28 27 26 25 24 23	Dedicated output ports Since the output transistor impedances are unbalanced CMOS, these pins can be effectively used for functions such as key scan timing. These pins go to the output high-impedance state in BACKUP mode. These pins go to the low level during a reset, i.e., when the $\overline{\text{RES}}$ pin is low.	Output	 <p style="text-align: right;">A01888</p>	
PD0 PD1 PD2 PD3	22 21 20 19	Dedicated output port These are normal CMOS outputs. These pins go to the output high-impedance state in BACKUP mode. These pins go to the low level during a reset, i.e., when the $\overline{\text{RES}}$ pin is low.			
PE0 PE1 PE2 PE3	18 17 16 15	I/O port These pins are switched between input and output as follows. Once an input instruction (IN, TPT, or TPF) is executed, these pins latch in the input mode. Once an output instruction (OUT, SPB, or RPB) is executed, they latch in the output mode. These pins go to the input mode during a reset, i.e., when the $\overline{\text{RES}}$ pin is low. In BACKUP mode these pins go to the input mode with input disabled.	I/O	 <p style="text-align: right;">A01905</p>	Data I/O PE0: D0 PE1: D1 PE2: D2 PE3: D3
PF0 PF1 PF2 PF3	14 13 12 11	I/O port These pins are switched between input and output by the FPC instruction. The I/O states of this port can be specified for individual pins. These pins go to the input mode during a reset, i.e., when the $\overline{\text{RES}}$ pin is low. In BACKUP mode these pins go to the input mode with input disabled.			PF0: D4 PF1: D5 PF2: D6 PF3: D7
PG0 PG1	6 5	Dedicated input port Input through these pins is disabled in BACKUP mode.	Input	 <p style="text-align: right;">A01906</p>	PROM control signal inputs PG0: $\overline{\text{CE}}$ PG1: $\overline{\text{OE}}$
PG2 PG3	4 3			 <p style="text-align: right;">A01891</p>	

Continued on next page.

LC72P32

Continued from preceding page.

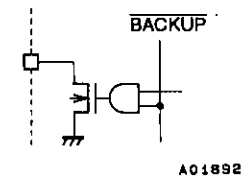
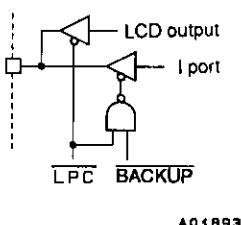
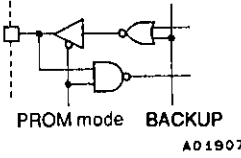
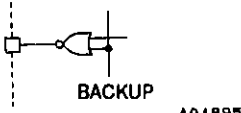
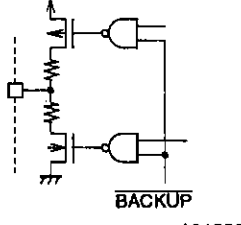
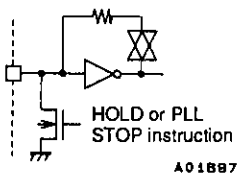
Pin	Pin No.	Function	I/O	Circuit type	PROM mode function
PH0 PH1 PH2 PH3	10 9 8 7	Dedicated output port Since these pins are high breakdown voltage n-channel transistor open-drain outputs, they can be effectively used for functions such as band power supply switching. Note that PH2 and PH3 also function as the DAC1 and DAC2 outputs. These pins go to the high impedance state during a reset, i.e., when the \overline{RES} pin is low, and in BACKUP mode.	Output	 A01892	
PI0/S25 PI1/S26 PI2/S27 PI3/S28	39 38 37 36	Dedicated output port While these pins have a CMOS output circuit structure, they can be switched to function as LCD drivers. Their function is switched by the SS and RS instructions. These pins cannot be switched individually. The LCD driver function is selected and a segment off signal is output when power is first applied or when \overline{RES} is low. These pins are held at the low level in BACKUP mode. Note that when the general-purpose port use option is specified, these pins output the contents of IPORT when LPC is 1, and the contents of the general-purpose output port LATCH when LPC is 0.	Output	 A01893	
S1 to S14	63 to 50	LCD driver segment outputs A frame frequency of 100 Hz and a 1/2 duty, 1/2 bias drive type are used. A segment off signal is output when power is first applied or when \overline{RES} is low.	I/O	 A01907	Address input S: A0 to S14: A13
S15 to S24	49 to 40	These pins are held at the low level in BACKUP mode. The use of these pins as general-purpose output ports can be specified as an option.	Output	 A01895	
COM1 COM2	65 64	LCD driver common outputs A 1/2 duty, 1/2 bias drive type is used. The output when power is first applied or when \overline{RES} is low is identical to the normal operating mode output. These pins are held at the low level in BACKUP mode.	Output	 A01898	
FMIN	74	FM VCO (local oscillator) input The input must be capacitor-coupled. The input frequency range is from 10 to 130 MHz.	Input	 A01897	
AMIN	75	AM VCO (local oscillator) input The input should be capacitor-coupled. The band supported by this pin can be selected using the PLL instruction. High (2 to 40 MHz) → SW Low (0.5 to 10 MHz) → LW and MW			

Continued on next page.

LC72P32

Continued from preceding page.

Pin	Pin No.	Function	I/O	Circuit type	PROM mode function
HCTR	70	Universal counter input The input should be capacitor-coupled. The input frequency range is from 0.4 to 12 MHz. This input can be effectively used for FM IF or AM IF counting.	Input		
LCTR	71	Universal counter input The input should be capacitor-coupled for input frequencies in the range 100 to 150 kHz. Capacitor coupling is not required for input frequencies from 1 to 20 Hz. This input can be effectively used for AM IF counting.			
ADI	69	A/D converter input A 1.28 ms period is required for a 6-bit sequential comparison conversion. The full scale input is $((63/96) \cdot V_{DD})$ for a data value of 3FH.	Input		
$\overline{\text{INT}}$	66	Interrupt request input An interrupt is generated when the INTEN flag is set (by an SS instruction) and a falling edge is input.	Input		
EO1 EO2	77 78	Reference frequency and programmable divisor phase comparison error outputs Charge pump circuits are built in. EO1 and EO2 are the same.	Output		
$\overline{\text{SNS}}$	72	Input pin used to determine if a power outage has occurred in BACK UP mode This pin can also be used as a normal input port.	Input		
$\overline{\text{HOLD}}$	67	Input pin used to force the LC72E32 to HOLD mode The LC72E32 goes to HOLD mode when the HOLDEN flag is set (by an SS instruction) and the $\overline{\text{HOLD}}$ input goes low. A high breakdown voltage circuit is used so that this input can be used in conjunction with the normal power switch.	Input		
$\overline{\text{RES}}$	68	System reset input This signal should be held low for 75 ms after power is first applied to effect a power-up reset. The reset starts when a low level has been input for at least six reference clock cycles.	Input		
XIN XOUT	1 80	Crystal oscillator connections (4.5 MHz) A feedback resistor is built in.	Input Output		
TEST1 TEST2	79 2	LSI test pins. These pins must be connected to V_{SS} .			
V_{DD}	31, 73	Power supply + connections. Both pins must be connected.			Programming voltage V_{pp}
V_{SS}	76	Power supply - connection.			

LC72P32

Option

No.	Description	Selections
1	WDT (watchdog timer) inclusion selection	WDT included
		No WDT
2	Port A pull-down resistor inclusion selection	Pull-down resistors included
		No pull-down resistors
3	Cycle time selection	2.67 μ s
		13.33 μ s
		40.00 μ s
4	LCD port/general-purpose port selection	LCD ports
		General-purpose output ports

Usage Notes

The LC72P32 is provided for use in early production runs of products designed for the LC7232N. Please keep the following points in mind when using this product.

1. Differences between the LC72P32 and the LC7232N

Parameter	LC72P32	LC7232N
Operating temperature (T _{opg})	-30 to +70 °C	-40 to +85°C
Operation immediately following power on	After the 75 ms power-on reset period, the LSI internal option settings are set up during a period of about 1 ms. After that operation completes, program execution starts with the program counter set to location 0.	After the 75 ms power-on reset period, program execution starts with the program counter set to location 0.
Input type of the A port immediately following power on*	No pull-down resistors	Pull-down resistors are included or not according to the option specifications.
Output type of the S1 to S28 outputs immediately following power on*	LCD ports	These pins function as either LCD ports or general-purpose output ports according to the option specifications.
Power-down detection voltage (V _{DET})	Minimum: 3.0 V Typical: 3.5 V Maximum: 4.0 V	Minimum: 2.7 V Typical: 3.0 V Maximum: 3.3 V
Current drain	I _{DD2} Conditions: V _{DD} = 5.0 V, PLL stopped CT = 2.67 μ s (HOLD mode, Figure 1) Typical: 2.7 mA	Conditions: V _{DD2} , PLL stopped CT = 2.67 μ s (HOLD mode, Figure 1) Typical: 1.5 mA
	I _{DD3} Conditions: V _{DD} = 5.0 V, PLL stopped CT = 13.33 μ s (HOLD mode, Figure 1) Typical: 1.7 mA	Conditions: V _{DD2} , PLL stopped CT = 13.33 μ s (HOLD mode, Figure 1) Typical: 1.0 mA
	I _{DD4} Conditions: V _{DD} = 5.0 V, PLL stopped CT = 40.00 μ s (HOLD mode, Figure 1) Typical: 1.5 mA	Conditions: V _{DD2} , PLL stopped CT = 40.00 μ s (HOLD mode, Figure 1) Typical: 0.7 mA
The TEST1 and TEST2 pins	These are LSI test pins and must be connected to V _{SS} .	These are LSI test pins and must be either left open or connected to V _{SS} .
Supply voltage	V _{DD2} Conditions: CPU operating Minimum: 4.0 V	Conditions: CPU operating Minimum: 3.5 V

Note: * This refers to the option setup time of about 1 ms that occurs following the period of about 75 ms from power application.

2. PLA and options

The LC72P32 uses locations 2000H to 201FH as program memory for PLA pattern specification, and locations 2020H to 2033H for option specification. This option specification allows the LC72P32 to support option setups identical to those available with the LC7232N.

• LC72P32 Option Types

Symbol	Option Type	Selections
WDT	WDT (watchdog timer) inclusion selection	WDT included
		No WDT
APPDN	A port pull-down resistor inclusion selection	Pull-down resistors included
		No pull-down resistors
CTIM	Cycle time selection	2.67 μ s
		13.33 μ s
		40.00 μ s
LCDP	LCD port/general-purpose port selection	LCD ports
		General-purpose output ports

Note that these options are not determined until the option setting period of about 1 ms, which follows a period of about 75 ms from power application, has passed.

3. Use of the mass-produced unit printed circuit board

When using the printed circuit board for the massed produced end product with the LC72P32, be sure to connect the TEST1 and TEST2 pins to V_{SS} and be sure to connect both pins 31 and 73 (the V_{DD} pins) to the plus side of the power supply.

4. PROM address space

2033H	All locations set to "00H"	Option specification area
2024H		
2023H		
2022H		
2021H		
2020H	WDT	
201FH	PLA2	PLA specification area
2010H		
200FH		
2000H	PLA1	
1FFFH		Program area 8 Kbytes (4 Kwords x 16 bits)
0000H		

5. Notes on ordering ROM when using Sanyo's (for fee) PROM writing service

- When ordering one-time programmable and mask ROM versions at the same time
The customer must provide a PROM to which the mask ROM version program and option data have been written. The customer must also provide ordering forms for both the mask ROM version and one-time programmable version products.
- When ordering only one-time programmable versions
The customer must provide a PROM to which the one-time programmable version program and option data have been written. The customer must also provide ordering forms for the one-time programmable version product.

6. Conditions prior to mounting

- Use the procedure below for mounting unwritten PROM products.

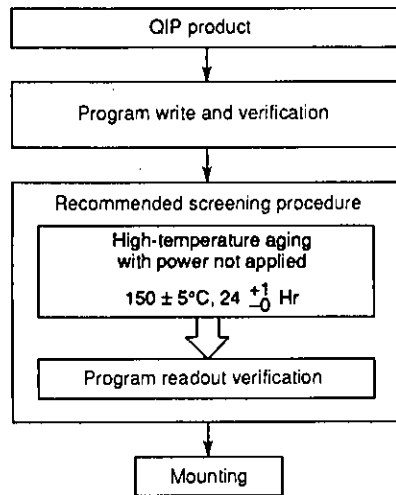

- When Sanyo's (for fee) PROM writing service is used

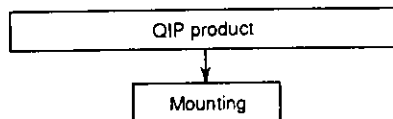

Note: Due to the structure of microcontrollers with built-in one-time programmable PROM (unwritten PROM products), complete testing prior to shipment is not possible. Thus there are cases where the writing yield may be lower.

Usage Techniques

1. Writing the built-in PROM

The following two techniques can be used to write the LC72P32's built-in PROM.

- Using a general-purpose EPROM programmer

If a general-purpose EPROM programmer is used, the built-in PROM can be written by using a dedicated writing adapter available from Sanyo (product name: LC72E32 ADAPTER FOR EPROM PROGRAMMER). Note that the 27512 ($V_{pp} = 12.5\text{ V}$) Intel fast writing method should be used, and the address range should be set to locations 0 to 2033H.

- Using the RE32 in-circuit emulator

If the RE32 in-circuit emulator is used, the built-in PROM can be written by using a dedicated writing adapter available from Sanyo (product name: LC72E32 ADAPTER FOR RE32). Use the PGOTP command to write data to the PROM.

2. Dedicated writing adapter

There are two writing adapters available for use with the LC72P32. These adapters are not interchangeable and each adapter must be used only for its intended purpose.

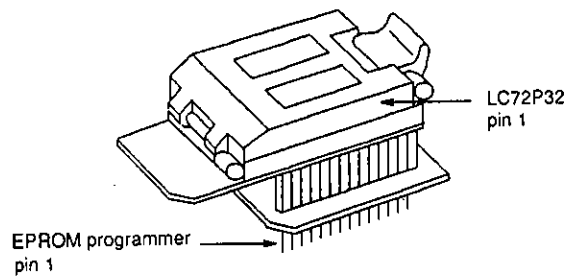

Note: The two writing adapters have essentially identical external appearances.

General purpose EPROM programmer adapter:

Product name: LC72E32 Adapter for EPROM Programmer

Product code: NDK-DC-001-A

RE32 in-circuit emulator adapter:

Product name: LC72E32 Adapter for RE32

Product code: NDK-DC-003-A

Pin Assignment

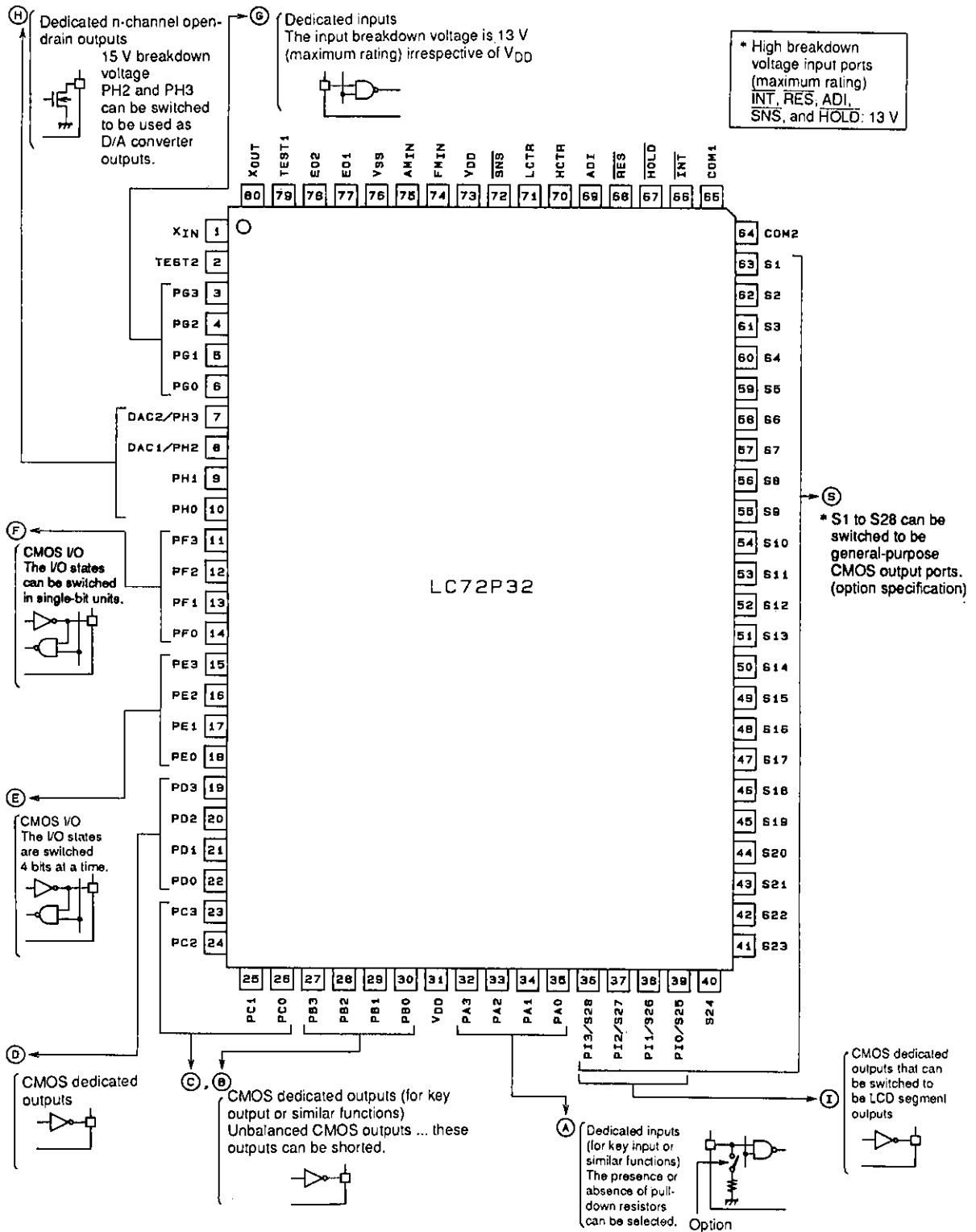

A02017

Block Diagram

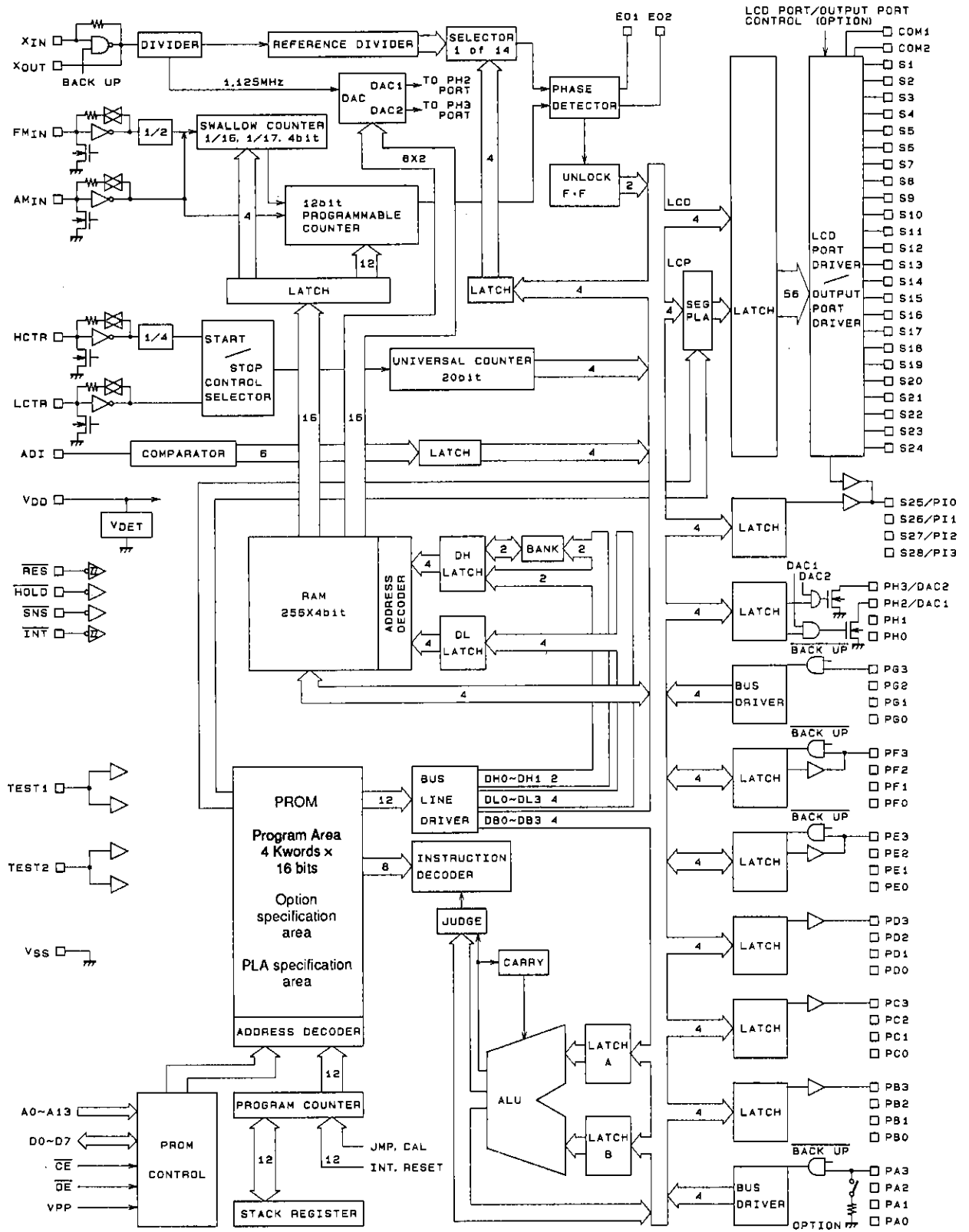

A01904

LC72P32 Instruction Table

Abbreviations:

- ADDR: Program memory address [12 bits]
- b: Borrow
- B: Bank number [2 bits]
- C: Carry
- DH: Data memory address high (row address) [2 bits]
- DL: Data memory address low (column address) [4 bits]
- I: Immediate data [4 bits]
- M: Data memory address
- N: Bit position [4 bits]
- Pn: Port number [4 bits]
- r: General register (one of the locations 00 to 0FH in bank 0)
- Rn: Register number [4 bits]
- (): Contents of register or memory
- ()n: Contents of bit N of register or memory

Instruction Group	Mnemonic	Operand		Function	Operation	Machine code											
		1st	2nd			D15	14	13	12	11	10	9	8	7	6	5	4
Addition instructions	AD	r	M	Add M to r	$r \leftarrow (r) + (M)$	0	1	0	0	0	0	DH	DL	Rn			
	ADS	r	M	Add M to r, then skip if carry	$r \leftarrow (r) + (M)$ skip if carry	0	1	0	0	0	1	DH	DL	Rn			
	AC	r	M	Add M to r with carry	$r \leftarrow (r) + (M) + C$	0	1	0	0	1	0	DH	DL	Rn			
	ACS	r	M	Add M to r with carry, then skip if carry	$r \leftarrow (r) + (M) + C$ skip if carry	0	1	0	0	1	1	DH	DL	Rn			
	AI	M	I	Add I to M	$M \leftarrow (M) + I$	0	1	0	1	0	0	DH	DL	I			
	AIS	M	I	Add I to M, then skip if carry	$M \leftarrow (M) + I$ skip if carry	0	1	0	1	0	1	DH	DL	I			
	AIC	M	I	Add I to M with carry	$M \leftarrow (M) + I + C$	0	1	0	1	1	0	DH	DL	I			
	AICS	M	I	Add I to M with carry, then skip if carry	$M \leftarrow (M) + I + C$ skip if carry	0	1	0	1	1	1	DH	DL	I			
Subtraction instructions	SU	r	M	Subtract M from r	$r \leftarrow (r) - (M)$	0	1	1	0	0	0	DH	DL	Rn			
	SUS	r	M	Subtract M from r, then skip if borrow	$r \leftarrow (r) - (M)$ skip if borrow	0	1	1	0	0	1	DH	DL	Rn			
	SB	r	M	Subtract M from r with borrow	$r \leftarrow (r) - (M) - b$	0	1	1	0	1	0	DH	DL	Rn			
	SBS	r	M	Subtract M from r with borrow, then skip if borrow	$r \leftarrow (r) - (M) - b$ skip if borrow	0	1	1	0	1	1	DH	DL	Rn			
	SI	M	I	Subtract I from M	$M \leftarrow (M) - I$	0	1	1	1	0	0	DH	DL	I			
	SIS	M	I	Subtract I from M, then skip if borrow	$M \leftarrow (M) - I$ skip if borrow	0	1	1	1	0	1	DH	DL	I			
	SIB	M	I	Subtract I from M with borrow	$M \leftarrow (M) - I - b$	0	1	1	1	1	0	DH	DL	I			
	SIBS	M	I	Subtract I from M with borrow, then skip if borrow	$M \leftarrow (M) - I - b$ skip if borrow	0	1	1	1	1	1	DH	DL	I			
Comparison instructions	SEQ	r	M	Skip if r equals M	$r - M$ skip if zero	0	0	0	0	0	1	DH	DL	Rn			
	SGE	r	M	Skip if r is greater than or equal to M	$r - M$ skip if not borrow ($r \geq M$)	0	0	0	0	1	1	DH	DL	Rn			
	SEQL	M	I	Skip if M equal to I	$M - I$ skip if zero	0	0	1	1	0	1	DH	DL	I			
	SGEL	M	I	Skip if M is greater than or equal to I	$M - I$ skip if not borrow ($M \geq I$)	0	0	1	1	1	1	DH	DL	I			

Continued on next page.

LC72P32

Continued from preceding page.

Instruction Group	Mnemonic	Operand		Function	Operation	Machine code														
		1st	2nd			D15	14	13	12	11	10	9	8	7	6	5	4	3	2	1
Logical operation instructions	AND	M	I	AND I with M	$M \leftarrow (M) \wedge I$	0	0	1	1	0	0	DH	DL	I						
	OR	M	I	OR I with M	$M \leftarrow (M) \vee I$	0	0	1	1	1	0	DH	DL	I						
	EXL	r	M	Exclusive OR M with r	$r \leftarrow (r) \oplus (M)$	0	0	1	0	0	0	DH	DL	Rn						
Transfer instructions	LD	r	M	Load M to r	$r \leftarrow (M)$	1	0	0	0	0	0	DH	DL	Rn						
	ST	M	r	Store r to M	$M \leftarrow (r)$	1	0	0	0	0	1	DH	DL	Rn						
	MVRD	r	M	Move M to destination M referring to r in the same row	$[DH, Rn] \leftarrow (M)$	1	0	0	0	1	0	DH	DL	Rn						
	MVRS	M	r	Move source M referring to r to M in the same row	$M \leftarrow [DH, Rn]$	1	0	0	0	1	1	DH	DL	Rn						
	MVSR	M1	M2	Move M to M in the same row	$[DH, DL1] \leftarrow [DH, DL2]$	1	0	0	1	0	0	DH	DL1	DL2						
	MVI	M	I	Move I to M	$M \leftarrow I$	1	0	0	1	0	1	DH	DL	I						
	PLL	M	r	Load M to PLL registers	$PLL\ r \leftarrow PLL\ DATA$	1	0	0	1	1	0	DH	DL	Rn						
Bit test instructions	TMT	M	N	Test M bits, then skip if all bits specified are true	if $M(N) = \text{all "1"}$, then skip	1	0	1	0	0	1	DH	DL	N						
	TMF	M	N	Test M bits, then skip if all bits specified are false	if $M(N) = \text{all "0"}$, then skip	1	0	1	0	1	1	DH	DL	N						
Jump and subroutine call instructions	JMP	ADDR		Jump to the address	$PC \leftarrow ADDR$	1	0	1	1	ADDR (12 bits)										
	CAL	ADDR		Call subroutine	$PC \leftarrow ADDR$ $Stack \leftarrow (PC) + 1$	1	1	0	0	ADDR (12 bits)										
	RT			Return from subroutine	$PC \leftarrow Stack$	1	1	0	1	0	1	0	0	0	0	0	0	0	0	0
	RTI			Return from interrupt	$PC \leftarrow Stack$	1	1	0	1	0	1	0	1	0	0	0	0	0	0	0
F/F test instructions	TTM	N		Test timer F/F then skip if it has not been set	if timer $F/F = \text{"0"}$, then skip	1	1	0	1	0	1	1	0	0	0	0	0	N		
	TUL	N		Test unlock F/F then skip if it has not been set	if UL $F/F = \text{"0"}$, then skip	1	1	0	1	0	1	1	1	0	0	0	0	N		
Status register instructions	SS	N		Set status register	(Status register 1) $N \leftarrow 1$	1	1	0	1	1	1	0	0	0	0	0	N			
	RS	N		Reset status register	(Status register 1) $N \leftarrow 0$	1	1	0	1	1	1	0	1	0	0	0	N			
	TST	N		Test status register true	if (Status register 2) $N = \text{all "1"}$, then skip	1	1	0	1	1	1	1	0	0	0	0	N			
	TSF	N		Test status register false	if (Status register 2) $N = \text{all "0"}$, then skip	1	1	0	1	1	1	1	1	0	0	0	N			
Bank switching instructions	BANK	B		Select bank	$BANK \leftarrow B$	1	1	0	1	0	0	B	0	0	0	0	0	0	0	

Continued on next page.

LC72P32

Continued from preceding page.

Instruction Group	Mnemonic	Operand		Function	Operation	Machine code															
		1st	2nd			D15	14	13	12	11	10	9	8	7	6	5	4	3	2	1	D0
I/O instructions	LCD	M	I	Output segment pattern to LCD digit direct	LCD (DIGIT) ← M	1	1	1	0	0	0	DH	DL	DIGIT							
	LCP	M	I	Output segment pattern to LCD digit through PLA	LCD (DIGIT) ← PLA ← M	1	1	1	0	0	1	DH	DL	DIGIT							
	IN	M	P	Input port data to M	M ← (Port (P))	1	1	1	0	1	0	DH	DL	P							
	OUT	M	P	Output contents of M to port	(Port (P)) ← M	1	1	1	0	1	1	DH	DL	P							
	SPB	P	N	Set port bits	(Port (P)) N ← 1	1	1	1	1	0	0	0	0	P	N						
	RPB	P	N	Reset port bits	(Port (P)) N ← 0	1	1	1	1	0	1	0	1	P	N						
	TPT	P	N	Test port bits, then skip if all bits specified are true	if (Port (P)) N = all "1", then skip	1	1	1	1	1	0	1	0	P	N						
	TPF	P	N	Test port bits, then skip if all bits specified are false	if (Port (P)) N = all "0", then skip	1	1	1	1	1	1	1	1	P	N						
Universal counter instructions	UCS	I		Set I to UCCW1	UCCW1 ← I	0	0	0	0	0	0	0	1	0	0	0	0	I			
	UCC	I		Set I to UCCW2	UCCW2 ← I	0	0	0	0	0	0	1	1	0	0	0	0	I			
Other instructions	FPC	N		F port I/O control	FPC latch ← N	0	0	0	1	0	0	0	0	0	0	0	0	N			
	CKSTP			Clock stop	Stop clock if HOLD = 0	0	0	0	1	0	0	0	1	0	0	0	0	0	0	0	0
	DAC	I		Load M to D/A registers	DAreg ← DAC DATA	0	0	0	0	0	0	1	0	0	0	0	0	I			
	NOP			No operation		0	0	0	0	0	0	0	0	0	0	0	0	0	0	0	0

■ No products described or contained herein are intended for use in surgical implants, life-support systems, aerospace equipment, nuclear power control systems, vehicles, disaster/crime-prevention equipment and the like, the failure of which may directly or indirectly cause injury, death or property loss.

■ Anyone purchasing any products described or contained herein for an above-mentioned use shall:

- ① Accept full responsibility and indemnify and defend SANYO ELECTRIC CO., LTD., its affiliates, subsidiaries and distributors and all their officers and employees, jointly and severally, against any and all claims and litigation and all damages, cost and expenses associated with such use;
- ② Not impose any responsibility for any fault or negligence which may be cited in any such claim or litigation on SANYO ELECTRIC CO., LTD., its affiliates, subsidiaries and distributors or any of their officers and employees jointly or severally.

■ Information (including circuit diagrams and circuit parameters) herein is for example only; it is not guaranteed for volume production. SANYO believes information herein is accurate and reliable, but no guarantees are made or implied regarding its use or any infringements of intellectual property rights or other rights of third parties.