

TRIACS

DESCRIPTION

Glass passivated , sensitive gate triacs in a full plastic envelope, intended for use in general purpose bidirectional switching and phase control applications, where high sensitivity is required in all four quadrants.

SYMBOL

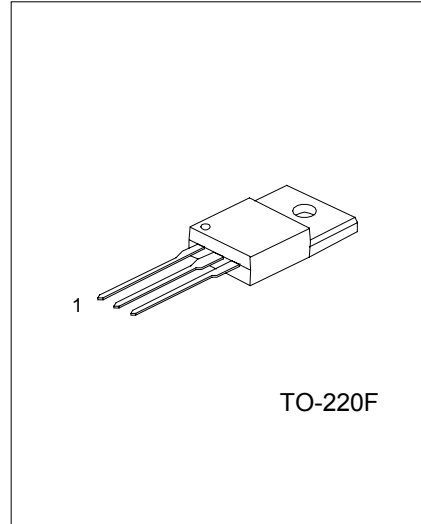
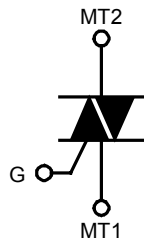

1:MT1 2:MT2 3:GATE

ABSOLUTE MAXIMUM RATINGS (Tj=25°C)

PARAMETER	SYMBOL	RATING	UNIT
Repetitive Peak Off-State Voltages UT138FE-5 UT138FE-6 UT138FE-8	V _{DRM}	500* 600* 800	V
RMS On-state Current (Full sine wave; T _{hs} ≤ 56°C)	I _{T(RMS)}	12	A
Non-repetitive Peak. On-State Current (Full sine wave, T _j =125°C prior to surge, with reapplied V _{DRM(max)})	I _{TSM}	90 100	A
		t=20ms t=16.7ms	
I ² t For Fusing (t=10ms)	I ² t	40	A ² s
Repetitive Rate of Rise of On-state Current after Triggering (I _{TM} =20A, I _G =0.2A, dI _G /dt=0.2A/μs)	dI _T /dt	50 50 50 10	A/μs
		T2+ G+ T2+ G- T2- G- T2- G+	
Peak Gate Voltage	V _{GM}	5	V
Peak Gate Current	I _{GM}	2	A
Peak Gate Power	P _{GM}	5	W
Average Gate Power (over any 20 ms period)	P _{G(AV)}	0.5	W
Operating Junction Temperature	T _j	125	°C
Storage Temperature	T _{stg}	-40~150	°C

*Although not recommended, off-state voltages up to 800V may be applied without damage, but the triac may switch to the on-state. The rate of rise of current should not exceed 15A/μs.

ISOLATION LIMITING VALUE & CHARACTERISTIC (T_{HS}=25°C, unless otherwise specified)

PARAMETER	SYMBOL	MIN	TYP	MAX	UNIT
Repetitive peak voltage from all three terminals to external heatsink (R.H. ≤ 65%, clean and dustfree)	V _{isol}			1500	V
Capacitance from MT2 to external heatsink (f=1MHz)	C _{isol}		12		pF

THERMAL RESISTANCES

PARAMETER	SYMBOL	MIN	TYP	MAX	UNIT
Thermal Resistance, Junction to heatsink (full or half cycle) with heatsink compound without heatsink compound	R _{thj-hs}			4.0 5.5	K/W
Thermal Resistance, Junction to Ambient In free air	R _{thj-a}		55		K/W

STATIC CHARACTERISTICS (T_J=25°C, unless otherwise specified)

PARAMETER	SYMBOL	TEST CONDITIONS	MIN	TYP	MAX	UNIT
Gate Trigger Current	I _{GT}	V _D =12V, I _T =0.1A T2+ G+ T2+ G- T2- G- T2- G+		2.5 4.0 5.0 11	10 10 10 25	mA
Latching Current	I _L	V _D =12V, I _{GT} =0.1A T2+ G+ T2+ G- T2- G- T2- G+		3.2 16 4.0 5.5	30 40 30 40	mA
Holding Current	I _H	V _D =12V, I _{GT} =0.1A		4.0	30	mA
On-State Voltage	V _T	I _T =15A		1.4	1.65	V
Gate Trigger Voltage	V _{GT}	V _D =12V, I _T =0.1A V _D =400V, I _T =0.1A, T _J =125°C	0.25	0.7	1.5	V
Off-state Leakage Current	I _D	V _D =V _{DRM(max)} , T _J =125°C		0.1	0.5	mA

DYNAMIC CHARACTERISTICS (T_J=25°C, unless otherwise specified)

PARAMETER	SYMBOL	TEST CONDITIONS	MIN	TYP	MAX	UNIT
Critical Rate Of Rise Of Off-State Voltage	dV _D /dt	V _{DM} =67% V _{DRM(max)} , T _J =125°C Exponential waveform, Gate open circuit		50		V/μs
Gate Controlled Turn-on Time	t _{gt}	I _{TM} =16A, V _D =V _{DRM(max)} , I _G =0.1A, dI _G /dt=5A/μs		2		μs

TYPICAL CHARACTERISTICS

Figure 1. Maximum on-state Dissipation, P_{tot} vs rms On-state Current, $I_T(RMS)$, Where α = conduction Angle.

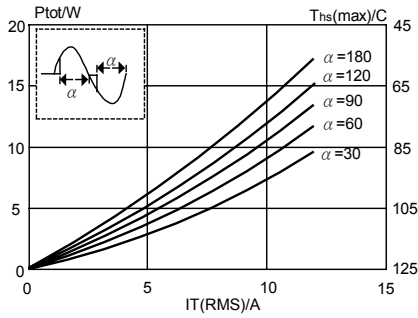

Figure 4. Maximum Permissible RMS Current $I_T(RMS)$ vs heatsink Temperature T_{hs}

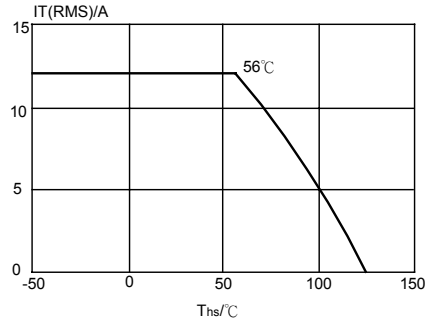

Figure 2. Maximum Permissible Non-repetitive Peak On-state Current I_{TSM} , vs Pulse Width t_p , for Sinusoidal Currents, $t_p \leq 20ms$

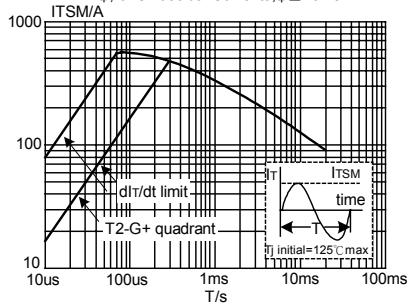

Figure 5. Maximum Permissible Repetitive rms on-state Current $I_T(RMS)$, vs Surge Duration, for Sinusoidal Currents, $f=50Hz; T_{hs} \leq 56^\circ C$

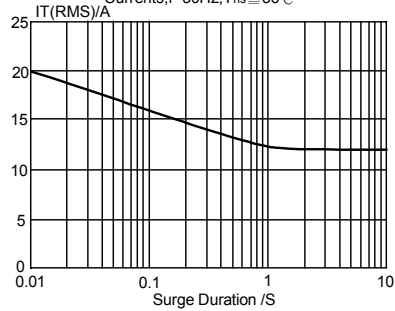

Figure 3. Maximum Permissible Non-Repetitive peak on-state Current I_{TSM} , vs Number of Cycles, for Sinusoidal Currents, $f=50Hz$

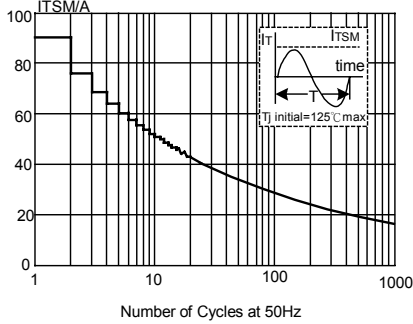
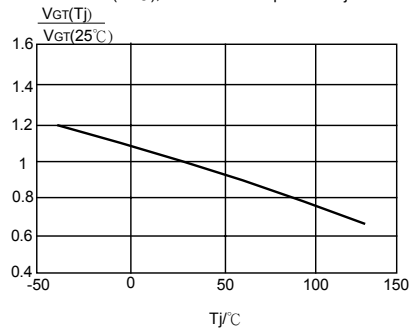
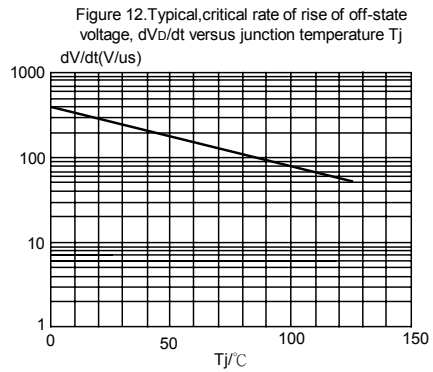
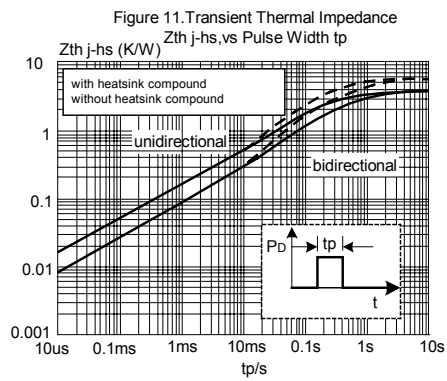
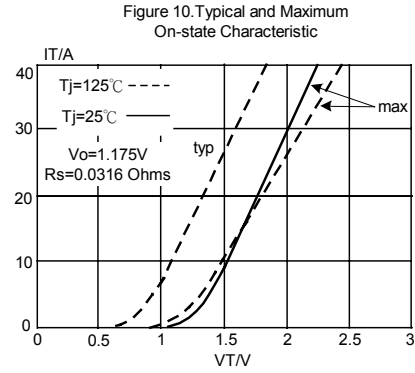
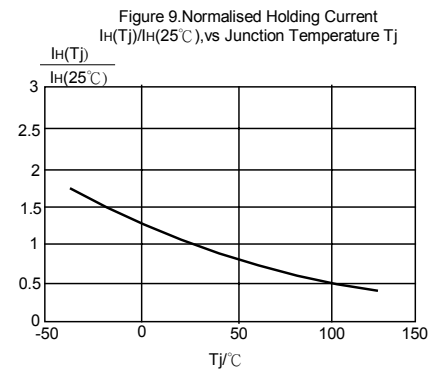
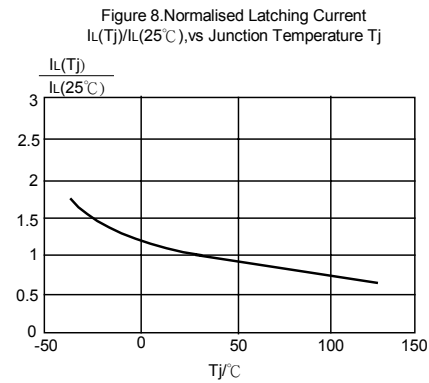
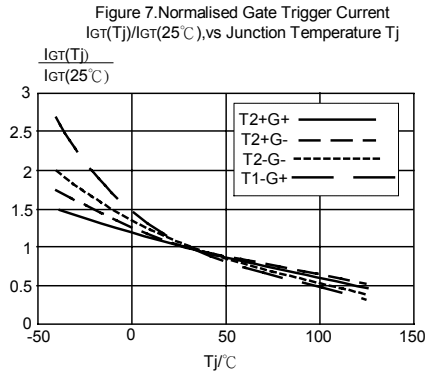

Figure 6. Normalised Gate Trigger Voltage $V_{GT}(T_j)/V_{GT}(25^\circ C)$, vs Junction Temperature T_j





UTC assumes no responsibility for equipment failures that result from using products at values that exceed, even momentarily, rated values (such as maximum ratings, operating condition ranges, or other parameters) listed in products specifications of any and all UTC products described or contained herein. UTC products are not designed for use in life support appliances, devices or systems where malfunction of these products can be reasonably expected to result in personal injury. Reproduction in whole or in part is prohibited without the prior written consent of the copyright owner. The information presented in this document does not form part of any quotation or contract, is believed to be accurate and reliable and may be changed without notice.