



2N4401

NPN SILICON TRANSISTOR

NPN GENERAL PURPOSE AMPLIFIER

DESCRIPTION

The UTC **2N4401** is designed for use as a medium power amplifier and switch requiring collector currents up to 500mA.

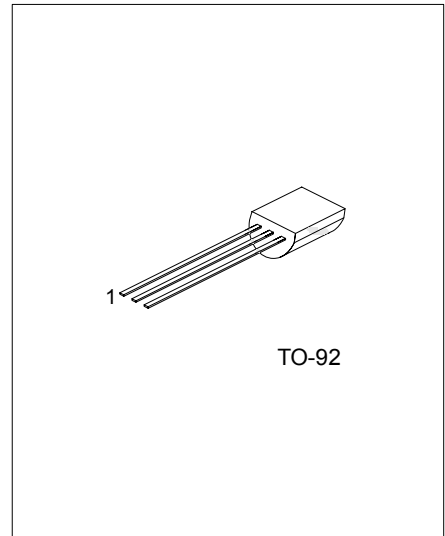

*Pb-free plating product number: 2N4401L

ORDERING INFORMATION

Order Number		Package	Pin Assignment			Packing
Normal	Lead Free Plating		1	2	3	
2N4401-T92-B	2N4401L-T92-B	TO-92	E	B	C	Tape Box
2N4401-T92-K	2N4401L-T92-K	TO-92	E	B	C	Bulk

<p>2N4401L-T92-R</p> <ul style="list-style-type: none"> (1) Packing Type (2) Package Type (3) Lead Plating 	<ul style="list-style-type: none"> (1) B: Tape Box, K: Bulk (2) T92: TO-92 (3) L: Lead Free Plating, Blank: Pb/Sn
---------------------------------------------------------------------------------------------------------------------------------------------	----------------------------------------------------------------------------------------------------------------------------------------------------

■ ABSOLUTE MAXIMUM RATING (Ta=25 , unless otherwise specified)

PARAMETER	SYMBOL	RATINGS	UNIT
Collector-Base Voltage	V _{CBO}	60	V
Collector-Emitter Voltage	V _{CEO}	40	V
Emitter-Base Voltage	V _{EBO}	6	V
Collector Current-Continuous	I _C	600	mA
Total Device Dissipation Derate above 25	P _D	625 5.0	mW mW/
Junction Temperature	T _J	+150	
Storage Temperature	T _{STG}	-40 ~ +150	

Note 1. These are steady state limits. The factory should be consulted on applications involving pulsed or low duty cycle operations.

2. Absolute maximum ratings are those values beyond which the device could be permanently damaged. Absolute maximum ratings are stress ratings only and functional device operation is not implied.

■ THERMAL DATA (Ta=25 , unless otherwise specified)

CHARACTERISTIC	SYMBOL	RATING	UNIT
Thermal Resistance, Junction to Ambient	θ _{JA}	200	/W
Thermal Resistance, Junction to Case	θ _{JC}	83.3	/W

■ ELECTRICAL CHARACTERISTICS (Ta=25 , unless otherwise specified)

PARAMETER	SYMBOL	TEST CONDITIONS	MIN	TYP	MAX	UNIT
OFF CHARACTERISTICS						
Collector-Base Breakdown Voltage	BV _{CBO}	I _C =0.1mA, I _E =0	60			V
Collector-Emitter Breakdown Voltage (note)	BV _{CEO}	I _C =1mA, I _B =0	40			V
Emitter-Base Breakdown Voltage	BV _{EBO}	I _E =0.1mA, I _C =0	6			V
Collector Cut-off Current	I _{CEX}	V _{CE} =35V, V _{EB} =0.4V				μA
Base Cut-off Current	I _{BL}	V _{CE} =35V, V _{EB} =0.4V				μA
ON CHARACTERISTICS (note)						
DC Current Gain	h _{FE1}	V _{CE} =1V, I _C =0.1mA	20			
	h _{FE2}	V _{CE} =1V, I _C =1mA	40			
	h _{FE3}	V _{CE} =1V, I _C =10mA	80			
	h _{FE4}	V _{CE} =1V, I _C =150mA	100		300	
	h _{FE5}	V _{CE} =2V, I _C =500mA	40			
Collector-Emitter Saturation Voltage	V _{CE(SAT1)}	I _C =150mA, I _B =15mA			0.4	V
	V _{CE(SAT2)}	I _C =500mA, I _B =50mA			0.75	V
Base-Emitter Saturation Voltage	V _{BE(SAT1)}	I _C =150mA, I _B =15mA	0.75		0.95	V
	V _{BE(SAT2)}	I _C =500mA, I _B =50mA			1.2	V
SMALL SIGNAL CHARACTERISTICS1						
Current Gain Bandwidth Product	f _T	V _{CE} =10V, I _C =20mA, f=100MHz	250			MHz
Collector-Base Capacitance	C _{cb}	V _{CB} =5V, I _E =0, f=140kHz			6.5	pF
Emitter-Base Capacitance	C _{eb}	V _{BE} =0.5V, I _C =0, f=140kHz			30	pF
Input Impedance	h _{ie}	V _{CE} =10V, I _C =1mA, f=1kHz	1		15	kΩ
Voltage Feedback Ratio	h _{re}	V _{CE} =10V, I _C =1mA, f=1kHz	0.1		8	×10 ⁻⁴
Small-Signal Current Gain	h _{fe}	V _{CE} =10V, I _C =1mA, f=1kHz	40		500	
Output Admittance	h _{oe}	V _{CE} =10V, I _C =1mA, f=1kHz	1		30	μmhos
SWITCHING CHARACTERISTICS						
Delay Time	t _d	V _{CC} =30V, V _{EB} =2V I _C =150mA I _{B1} =15mA			15	ns
Rise Time	t _r	V _{CC} =30V, V _{EB} =2V I _C =150mA I _{B1} =15mA			20	ns
Storage Time	t _s				225	ns
Fall Time	t _f	V _{CC} =30V, I _C =150mA I _{B1} = I _{B2} =15mA			30	ns

Note: Pulse test: PulseWidth≤300μs, Duty Cycles≤2%

■ TEST CIRCUIT

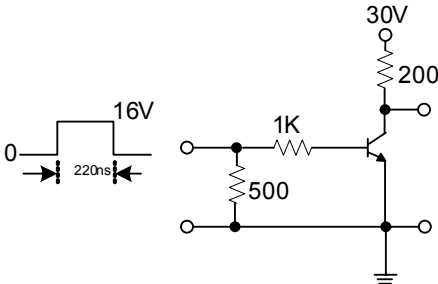

Figure1. Saturated Turn-On Switching Timer

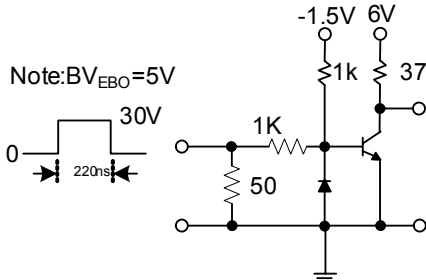
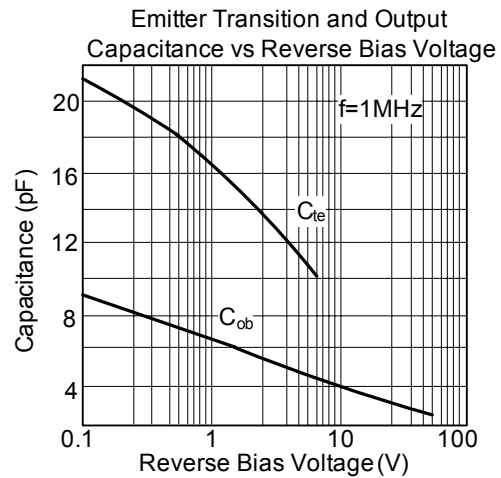
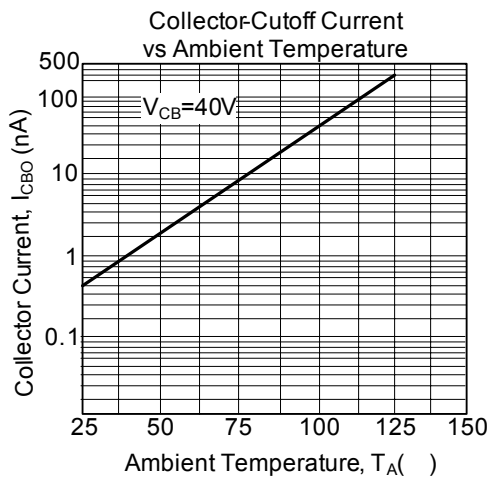
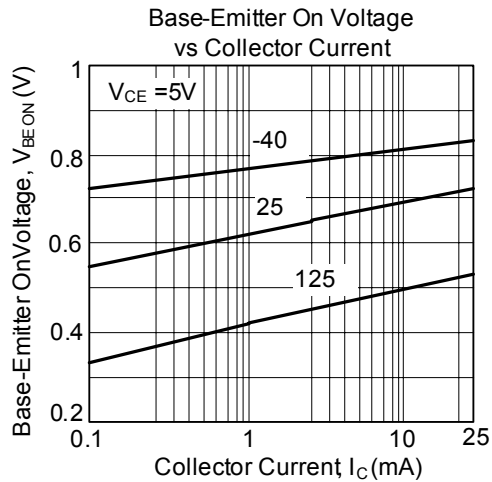
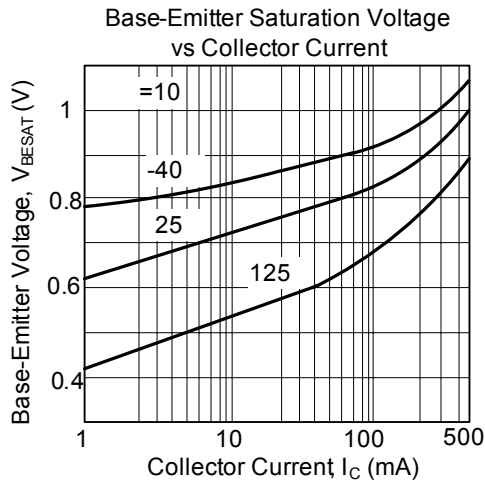
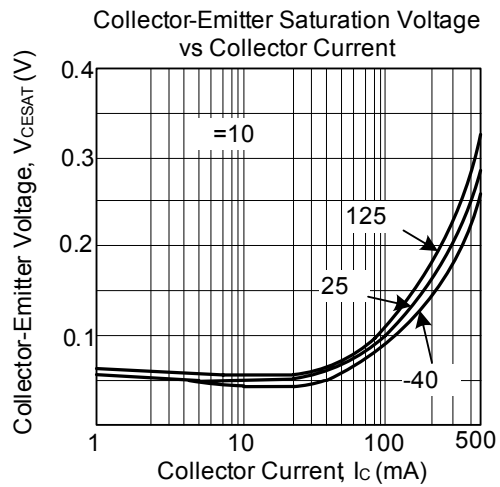
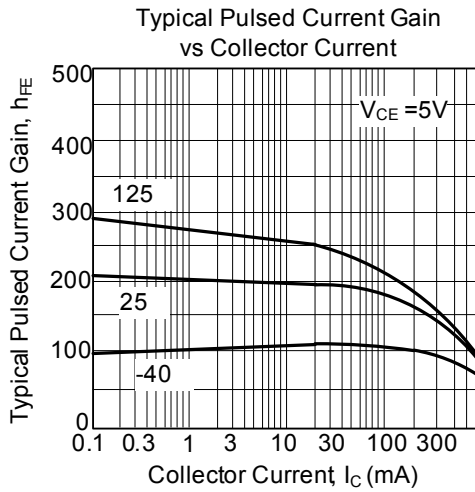
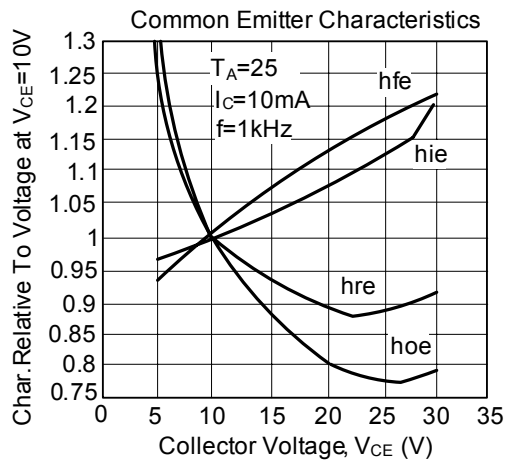
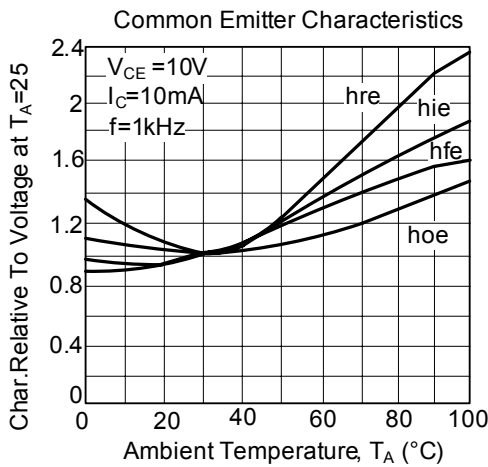
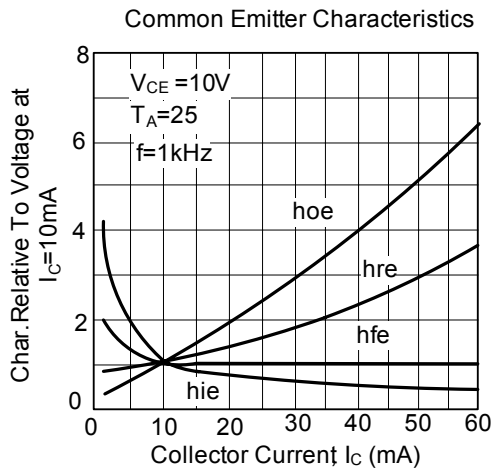
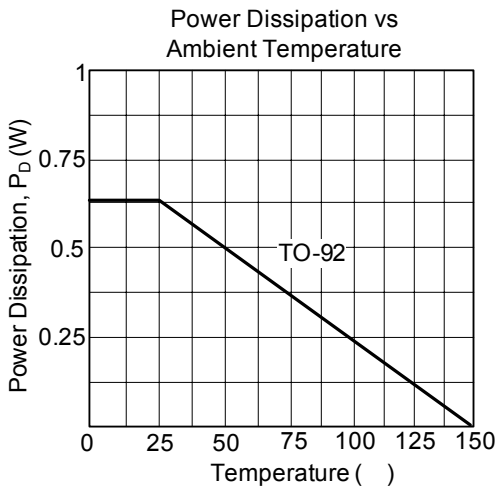
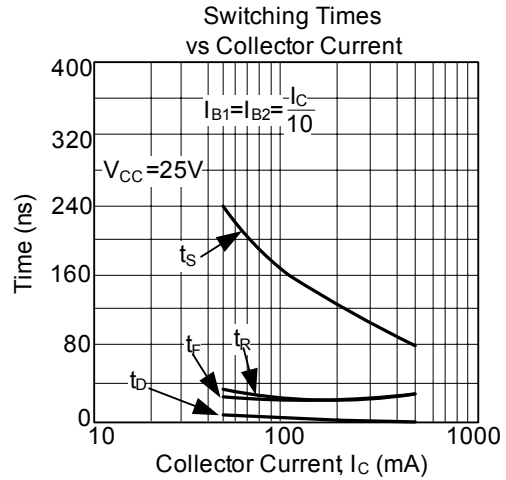
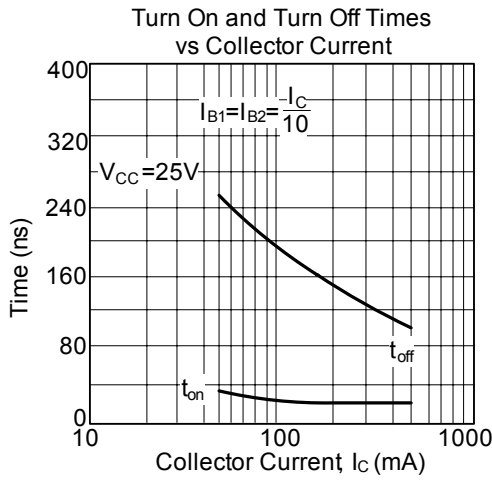

Figure2. Saturated Turn-Off Switching Timer

■ TYPICAL CHARACTERISTICS



■ TYPICAL CHARACTERISTICS(Cont.)



UTC assumes no responsibility for equipment failures that result from using products at values that exceed, even momentarily, rated values (such as maximum ratings, operating condition ranges, or other parameters) listed in products specifications of any and all UTC products described or contained herein. UTC products are not designed for use in life support appliances, devices or systems where malfunction of these products can be reasonably expected to result in personal injury. Reproduction in whole or in part is prohibited without the prior written consent of the copyright owner. The information presented in this document does not form part of any quotation or contract, is believed to be accurate and reliable and may be changed without notice.