

Compact low voltage thick film thermal printhead (8dots / mm)

KF2002-GF71A

These compact, lightweight printheads have low power requirements and are intended for ECR and mobile applications. Drawing 7.2V, a maximum print speed of 2 inches per second is possible.

●Applications

ECR printers
Hand-held printers

●Features

- 1) A wide range of power supply voltage, from 4.2V-8.5V, can be used to drive the printhead. This gives the flexibility for use with printers designed to operate with power from various battery configurations.
- 2) To allow the design of compact printers for use in calculators and other mobile applications, the basic specifications of the unit have been standardized. This gives engineers greater freedom to develop mechanical designs.
- 3) One rank resistance value of $210\Omega \pm 4\%$ eliminates the inconvenience of rank selection.

●External dimensions (Units : mm)

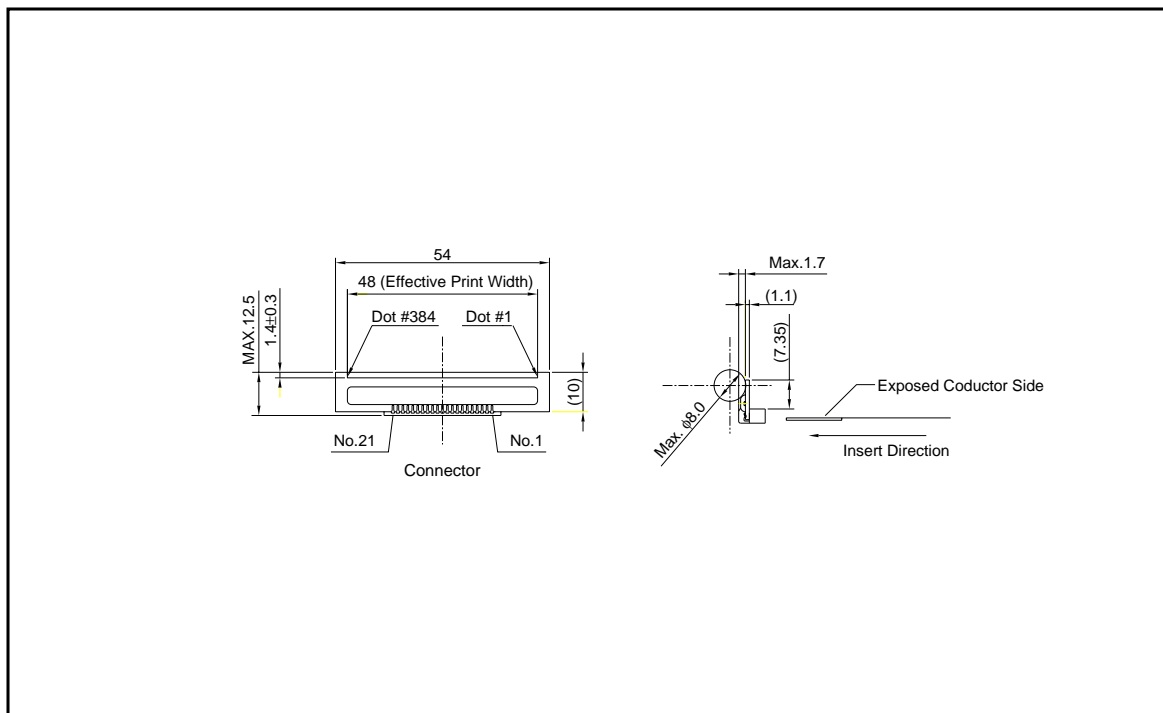

Printheads

●Equivalent circuit

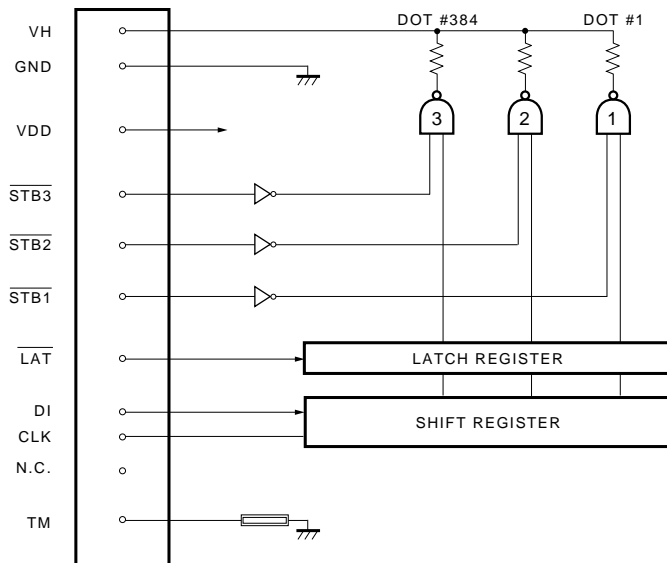

Fig.1

●Pin assignments

No.	Circuit
1	VH
2	VH
3	VH
4	N.C.
5	CLK
6	$\overline{\text{LAT}}$
7	$\overline{\text{STB2}}$
8	$\overline{\text{STB1}}$
9	GND
10	GND
11	GND

No.	Circuit
12	GND
13	GND
14	GND
15	TM
16	V _{DD}
17	$\overline{\text{STB3}}$
18	DI
19	VH
20	VH
21	VH

Printheads

●Timing chart

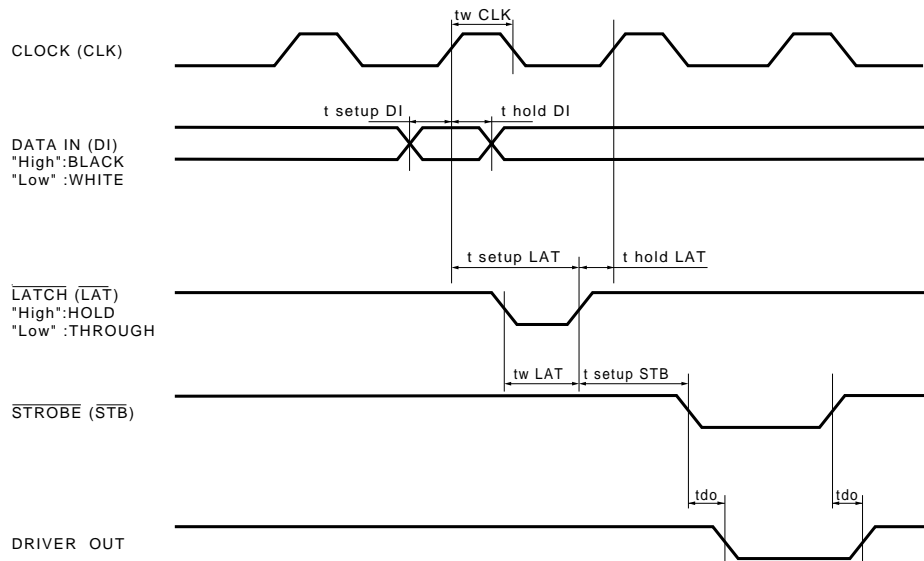

Fig.2

●Characteristics

Parameter	Symbol	Typical	Unit
Effective printing width	—	48	mm
Dot pitch	—	0.125	mm
Total dot number	—	384	dots
Average resistance value	Rave	210	Ω
Applied voltage	V_H	7.2	V
Applied power	P_O	0.14	W/dot
Print cycle	SLT	2.5	ms
Pulse width	T_{ON}	1.64	ms
Maximum number of dots energized simultaneously	—	144	dots
Maximum clock frequency	—	4	MHz
Maximum roller diameter	—	$\phi 8.0$	mm
Running life / pulse life	—	$50/1 \times 10^8$	km/pulses
Operating temperature	—	5~45	$^{\circ}\text{C}$

Printheads

●Electrical characteristic curves

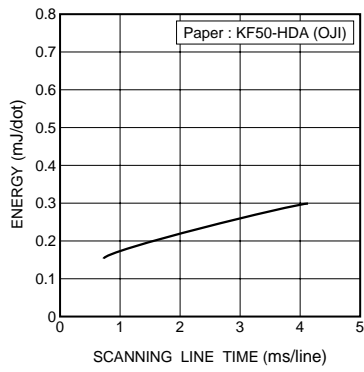

Fig.3 Adaptive speed chart

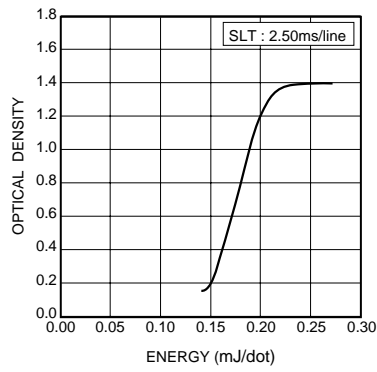

Fig.4 Representative density curve

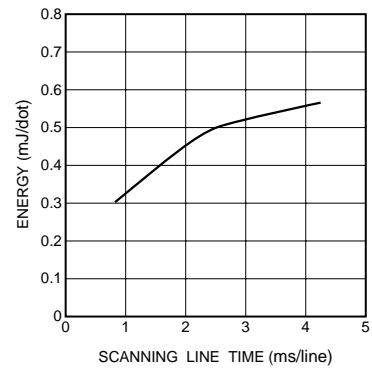

Fig.5 Maximum energy curve

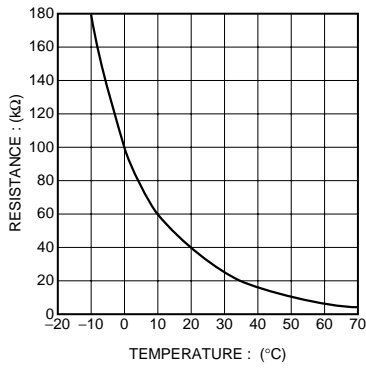

Fig.6 Thermistor curve

Notes

- No technical content pages of this document may be reproduced in any form or transmitted by any means without prior permission of ROHM CO.,LTD.
- The contents described herein are subject to change without notice. The specifications for the product described in this document are for reference only. Upon actual use, therefore, please request that specifications to be separately delivered.
- Application circuit diagrams and circuit constants contained herein are shown as examples of standard use and operation. Please pay careful attention to the peripheral conditions when designing circuits and deciding upon circuit constants in the set.
- Any data, including, but not limited to application circuit diagrams information, described herein are intended only as illustrations of such devices and not as the specifications for such devices. ROHM CO.,LTD. disclaims any warranty that any use of such devices shall be free from infringement of any third party's intellectual property rights or other proprietary rights, and further, assumes no liability of whatsoever nature in the event of any such infringement, or arising from or connected with or related to the use of such devices.
- Upon the sale of any such devices, other than for buyer's right to use such devices itself, resell or otherwise dispose of the same, no express or implied right or license to practice or commercially exploit any intellectual property rights or other proprietary rights owned or controlled by
- ROHM CO., LTD. is granted to any such buyer.
- Products listed in this document use silicon as a basic material.
Products listed in this document are no antiradiation design.

The products listed in this document are designed to be used with ordinary electronic equipment or devices (such as audio visual equipment, office-automation equipment, communications devices, electrical appliances and electronic toys).

Should you intend to use these products with equipment or devices which require an extremely high level of reliability and the malfunction of which would directly endanger human life (such as medical instruments, transportation equipment, aerospace machinery, nuclear-reactor controllers, fuel controllers and other safety devices), please be sure to consult with our sales representative in advance.

About Export Control Order in Japan

Products described herein are the objects of controlled goods in Annex 1 (Item 16) of Export Trade Control Order in Japan.

In case of export from Japan, please confirm if it applies to "objective" criteria or an "informed" (by MITI clause) on the basis of "catch all controls for Non-Proliferation of Weapons of Mass Destruction.