

# FJT44

## NPN Epitaxial Silicon Transistor

- High Voltage Transistor

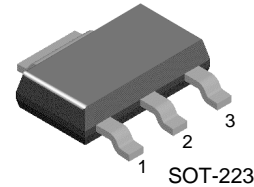

SOT-223

1. Base 2. Collector 3. Emitter

### Absolute Maximum Ratings\* $T_a=25^\circ\text{C}$ unless otherwise noted

Symbol	Parameter	Value	Units
$V_{CBO}$	Collector-Base Voltage	500	V
$V_{CEO}$	Collector-Emitter Voltage	400	V
$V_{EBO}$	Emitter-Base Voltage	6	V
$I_C$	Collector Current	300	mA
$P_C$	Collector Dissipation ( $T_a = 25^\circ\text{C}$ )	2	W
$T_J$	Junction Temperature	150	$^\circ\text{C}$
$T_{STG}$	Storage Temperature Range	- 55 ~ +150	$^\circ\text{C}$

\* These ratings are limiting values above which the serviceability of any semiconductor device may be impaired.

**NOTES:**

- 1) These ratings are based on a maximum junction temperature of  $150^\circ\text{C}$ .
- 2) These are steady state limits. The factory should be consulted on applications involving pulsed or low duty cycle operations.

### Thermal Characteristics\* $T_a=25^\circ\text{C}$ unless otherwise noted

Symbol	Parameter	Value	Units
$R_{\theta JA}$	Thermal Resistance, Junction to Ambient	62.5	$^\circ\text{C}/\text{W}$

\* Device mounted on FR-4 PCB 36 mm X 18 mm X 1.5 mm. mounting pad for the collector lead min.  $6\text{ cm}^2$

### Electrical Characteristics\* $T_a = 25^\circ\text{C}$ unless otherwise noted

Symbol	Parameter	Test Conditions	Min.	Typ.	Max.	Units
$BV_{CBO}$	Collector-Base Breakdown Voltage	$I_C = 100\mu\text{A}$ , $I_E = 0$	500			V
$BV_{CEO}$	Collector-Emitter Breakdown Voltage	$I_C = 1\text{mA}$ , $I_B = 0$	400			V
$BV_{EBO}$	Emitter-Base Breakdown Voltage	$I_E = 100\mu\text{A}$ , $I_C = 0$	6			V
$I_{CBO}$	Collector-Base Cutoff Current	$V_{CB} = 400\text{V}$ , $I_E = 0$			100	nA
$I_{CES}$	Collector-Emitter Cutoff Current	$V_{CE} = 400\text{V}$ , $V_{BE} = 0$			500	nA
$I_{EBO}$	Emitter-Base Cutoff Current	$V_{CE} = 4\text{V}$ , $I_C = 0$			100	nA
$h_{FE}$	DC Current Gain	$V_{CE}=10\text{V}$ , $I_C=1\text{mA}$ $V_{CE}=10\text{V}$ , $I_C=10\text{mA}$ $V_{CE}=10\text{V}$ , $I_C=50\text{mA}$ $V_{CE}=10\text{V}$ , $I_C=100\text{mA}$	40 50 45 40		200	
$V_{CE(sat)}$	Collector-Emitter Saturation Voltage	$I_C = 1\text{mA}$ , $I_B = 0.1\text{mA}$ $I_C = 10\text{mA}$ , $I_B = 1\text{mA}$ $I_C = 50\text{mA}$ , $I_B = 5\text{mA}$			0.4 0.5 0.75	V V V
$V_{BE(sat)}$	Base-Emitter Saturation Voltage	$I_C = 10\text{mA}$ , $I_B = 1\text{mA}$			0.75	V
$C_{obo}$	Output Capacitance	$V_{CB} = 20\text{V}$ , $I_E = 0$ , $f = 1\text{MHz}$			7	pF

\* Pulse Test: Pulse Width  $\leq 300\mu\text{s}$ , Duty Cycle  $\leq 2.0\%$

## Typical Performance Characteristics

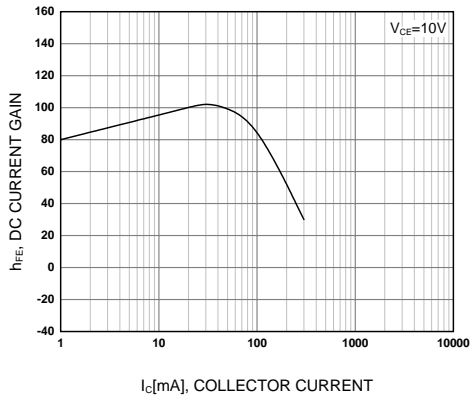

**Figure 1. DC current Gain**

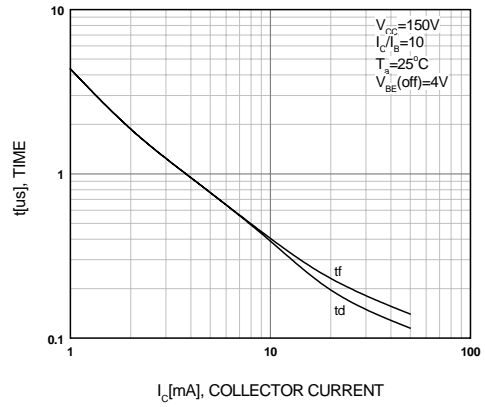

**Figure 2. Turn-On Switching Times**

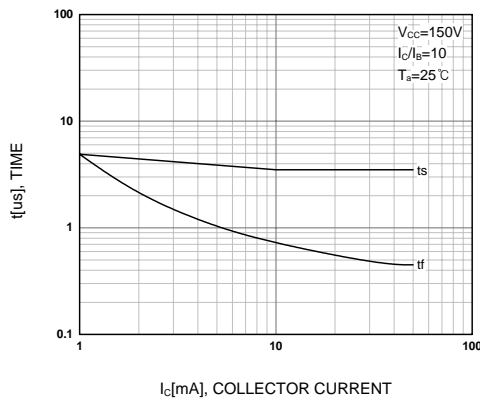

**Figure 3. Turn-Off Switching Times**

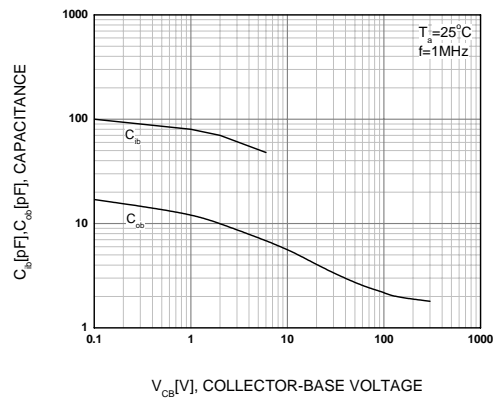

**Figure 4. Capacitance**

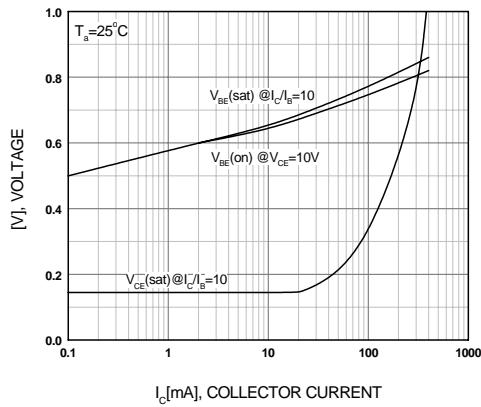

**Figure 5. On Voltage**

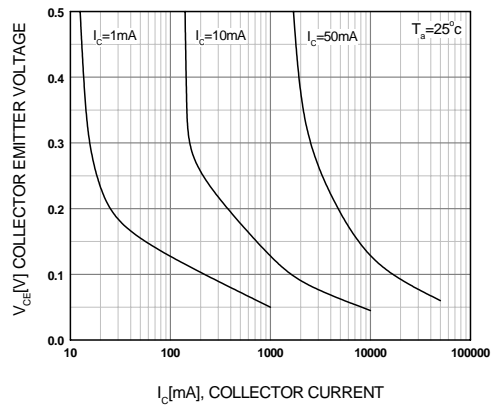

**Figure 6. Collector Saturation Region**

## Typical Performance Characteristics

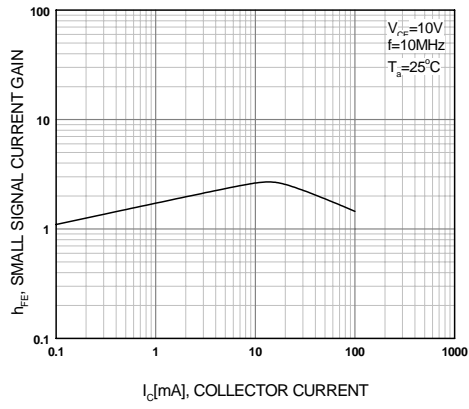
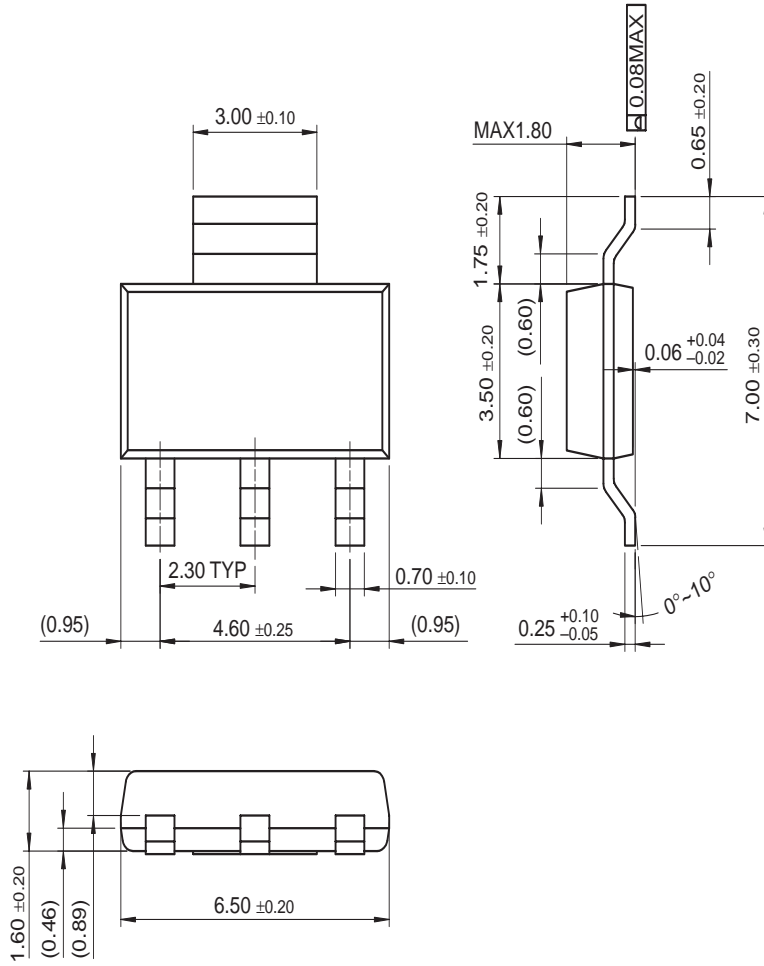

Figure 1. High Frequency Current Gain

Mechanical Dimensions

SOT-223



Dimensions in Millimeters

**TRADEMARKS**

The following are registered and unregistered trademarks Fairchild Semiconductor owns or is authorized to use and is not intended to be an exhaustive list of all such trademarks.

ACEx™	FACT Quiet Series™	OCX™	SILENT SWITCHER®	UltraFET®
ActiveArray™	GlobalOptoisolator™	OCXPro™	SMART START™	UniFET™
Bottomless™	GTO™	OPTOLOGIC®	SPM™	VCX™
Build it Now™	HiSeC™	OPTOPLANAR™	Stealth™	Wire™
CoolFET™	l <sup>2</sup> C™	PACMAN™	SuperFET™	
CROSSVOLT™	i-Lo™	POPT™	SuperSOT™-3	
DOMETM	ImpliedDisconnect™	Power247™	SuperSOT™-6	
EcoSPARK™	IntelliMAX™	PowerEdge™	SuperSOT™-8	
E <sup>2</sup> CMOS™	ISOPLANAR™	PowerSaver™	SyncFET™	
EnSigna™	LittleFET™	PowerTrench®	TCM™	
FACT™	MICROCOUPLER™	QFET®	TinyBoost™	
FAST®	MicroFET™	QS™	TinyBuck™	
FASTr™	MicroPak™	QT Optoelectronics™	TinyPWM™	
FPS™	MICROWIRE™	Quiet Series™	TinyPower™	
FRFET™	MSX™	RapidConfigure™	TinyLogic®	
	MSXPro™	RapidConnect™	TINYOPTO™	
Across the board. Around the world.™		μSerDes™	TruTranslation™	
The Power Franchise®		ScalarPump™	UHC™	
Programmable Active Droop™				

**DISCLAIMER**

FAIRCHILD SEMICONDUCTOR RESERVES THE RIGHT TO MAKE CHANGES WITHOUT FURTHER NOTICE TO ANY PRODUCTS HEREIN TO IMPROVE RELIABILITY, FUNCTION OR DESIGN. FAIRCHILD DOES NOT ASSUME ANY LIABILITY ARISING OUT OF THE APPLICATION OR USE OF ANY PRODUCT OR CIRCUIT DESCRIBED HEREIN; NEITHER DOES IT CONVEY ANY LICENSE UNDER ITS PATENT RIGHTS, NOR THE RIGHTS OF OTHERS. THESE SPECIFICATIONS DO NOT EXPAND THE TERMS OF FAIRCHILD'S WORLDWIDE TERMS AND CONDITIONS, SPECIFICALLY THE WARRANTY THEREIN, WHICH COVERS THESE PRODUCTS.

**LIFE SUPPORT POLICY**

FAIRCHILD'S PRODUCTS ARE NOT AUTHORIZED FOR USE AS CRITICAL COMPONENTS IN LIFE SUPPORT DEVICES OR SYSTEMS WITHOUT THE EXPRESS WRITTEN APPROVAL OF FAIRCHILD SEMICONDUCTOR CORPORATION.

As used herein:

- Life support devices or systems are devices or systems which, (a) are intended for surgical implant into the body, or (b) support or sustain life, or (c) whose failure to perform when properly used in accordance with instructions for use provided in the labeling, can be reasonably expected to result in significant injury to the user.
- A critical component is any component of a life support device or system whose failure to perform can be reasonably expected to cause the failure of the life support device or system, or to affect its safety or effectiveness.

**PRODUCT STATUS DEFINITIONS**

**Definition of Terms**

Datasheet Identification	Product Status	Definition
Advance Information	Formative or In Design	This datasheet contains the design specifications for product development. Specifications may change in any manner without notice.
Preliminary	First Production	This datasheet contains preliminary data, and supplementary data will be published at a later date. Fairchild Semiconductor reserves the right to make changes at any time without notice in order to improve design.
No Identification Needed	Full Production	This datasheet contains final specifications. Fairchild Semiconductor reserves the right to make changes at any time without notice in order to improve design.
Obsolete	Not In Production	This datasheet contains specifications on a product that has been discontinued by Fairchild semiconductor. The datasheet is printed for reference information only.

Rev. I20