

ZERO RECOVERY™ RECTIFIER

Features

- 1200 Volt Schottky Rectifier
- Zero Reverse Recovery
- Zero Forward Recovery
- High Frequency Operation
- Temperature Independent Switching Behavior
- Extremely Fast Switching
- Positive Temperature Coefficient on V_f

Benefits

- Replace Bipolar with Unipolar Rectifiers
- Essentially No Switching Losses
- Higher Efficiency
- Reduction Of Rectifier Heat Sink
- Parallel Devices without Thermal Runaway

Applications

- Switch Mode Power Supplies
- Power Factor Correction
- Motor Control
- High Voltage Multipliers

Package



Maximum Ratings

Parameter	Symbol	Value	Unit
Repetitive Peak Reverse Voltage	V_{RRM}	1200	V
Surge Peak Reverse Voltage	V_{RSM}	1200	V
DC Blocking Voltage	V_{DC}	1200	V
Average Forward Current $T_C=160^\circ\text{C}$	$I_{F(AV)}$	5	A
Repetitive Peak Forward Surge Current $T_C=25^\circ\text{C}$, $t_P=8.3\text{ms}$, Half Sine Wave	I_{FRM}	30	A
Non-Repetitive Peak Forward Surge Current $T_C=25^\circ\text{C}$, $t_P=10\mu\text{s}$, Pulse	I_{FSM}	100	A
Power Dissipation $T_C = 25^\circ\text{C}$	P_{tot}	136	W
Operating Junction and Storage Temperature	T_J, T_{stg}	-55 to +175	$^\circ\text{C}$

ELECTRICAL CHARACTERISTICS

Parameter	Symbol	Min	Typ	Max	Units
Forward Voltage $I_F = 5A$ $T_J = 25^\circ C$ $I_F = 5A$ $T_J = 175^\circ C$	V_F		1.6 2.6	1.8 3.0	V
Reverse Current $V_R = 1200V$ $T_J = 25^\circ C$ $V_R = 1200V$ $T_J = 150^\circ C$	I_R		50 100	200 1000	μA
Total Capacitive Charge $V_R = 1200V, I_F = 5A, di/dt = 500 A/\mu s, T_J = 25^\circ C$	Q_C		28		nC
Total Capacitance $V_R = 0V, T_J = 25^\circ C, f = 1MHz$ $V_R = 200V, T_J = 25^\circ C, f = 1MHz$ $V_R = 400V, T_J = 25^\circ C, f = 1MHz$	C		455 45 33		pF

NOTE:

1. This is a majority carrier diode, so there is no reverse recovery charge.

THERMAL CHARACTERISTICS

Characteristic	Symbol	Min	Typ	Max	Units
Thermal Resistance from Junction to Case	$R_{\theta JC}$		1.1		$^\circ C/W$

Typical Performance

Figure 1. Forward Characteristics

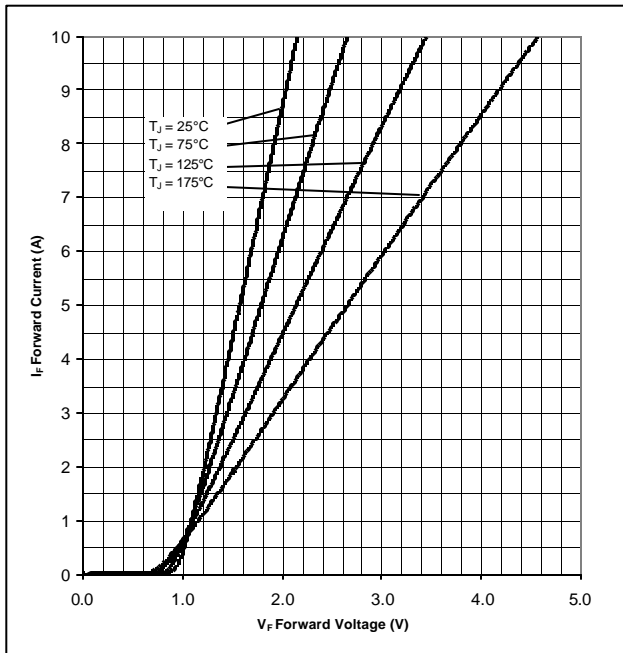

Figure 2. Reverse Characteristics

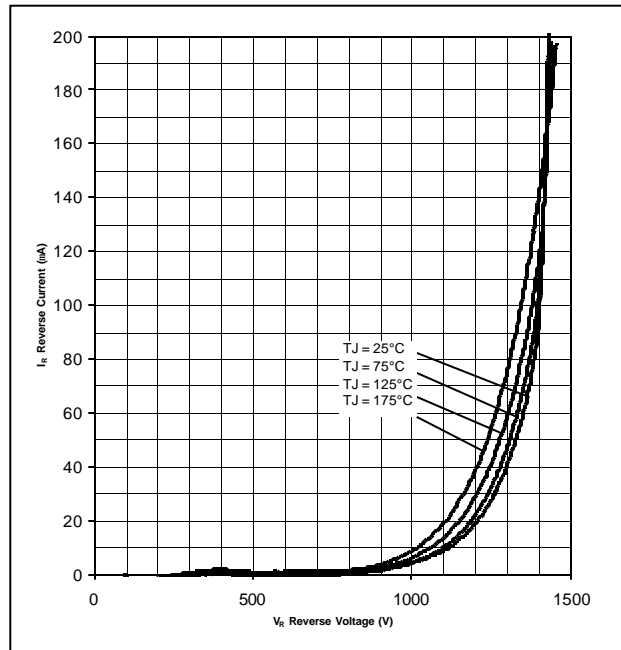

Figure 3. Current Derating

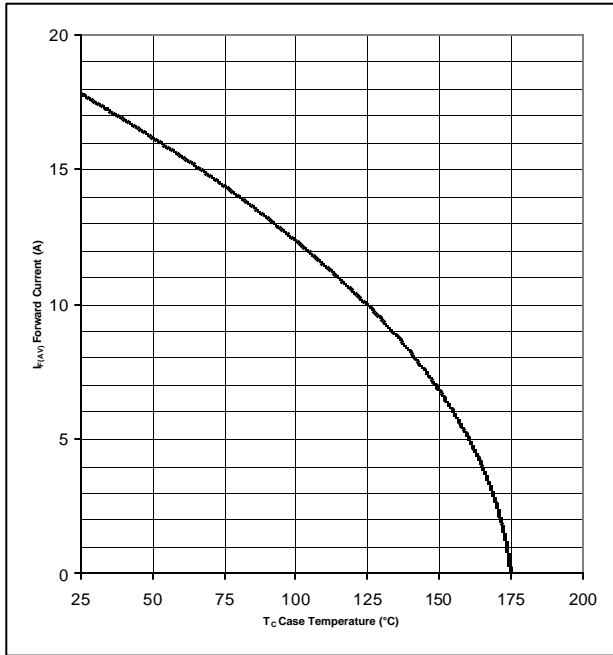

Figure 4. Capacitance vs. Reverse Voltage

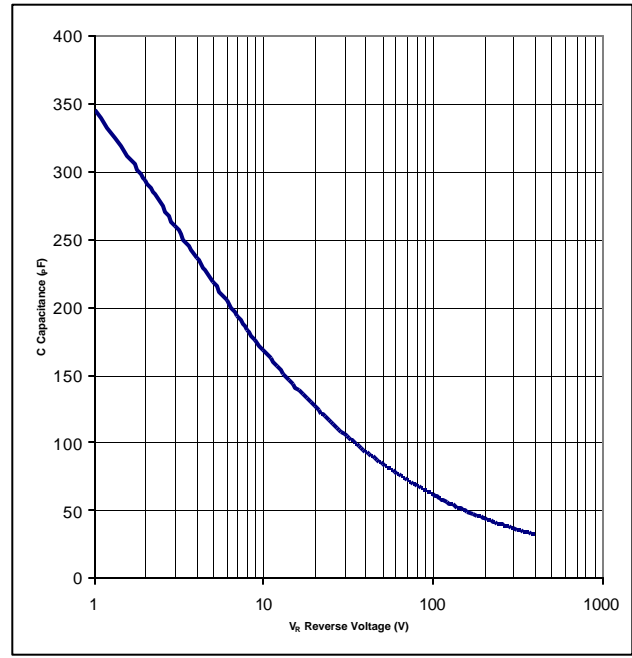
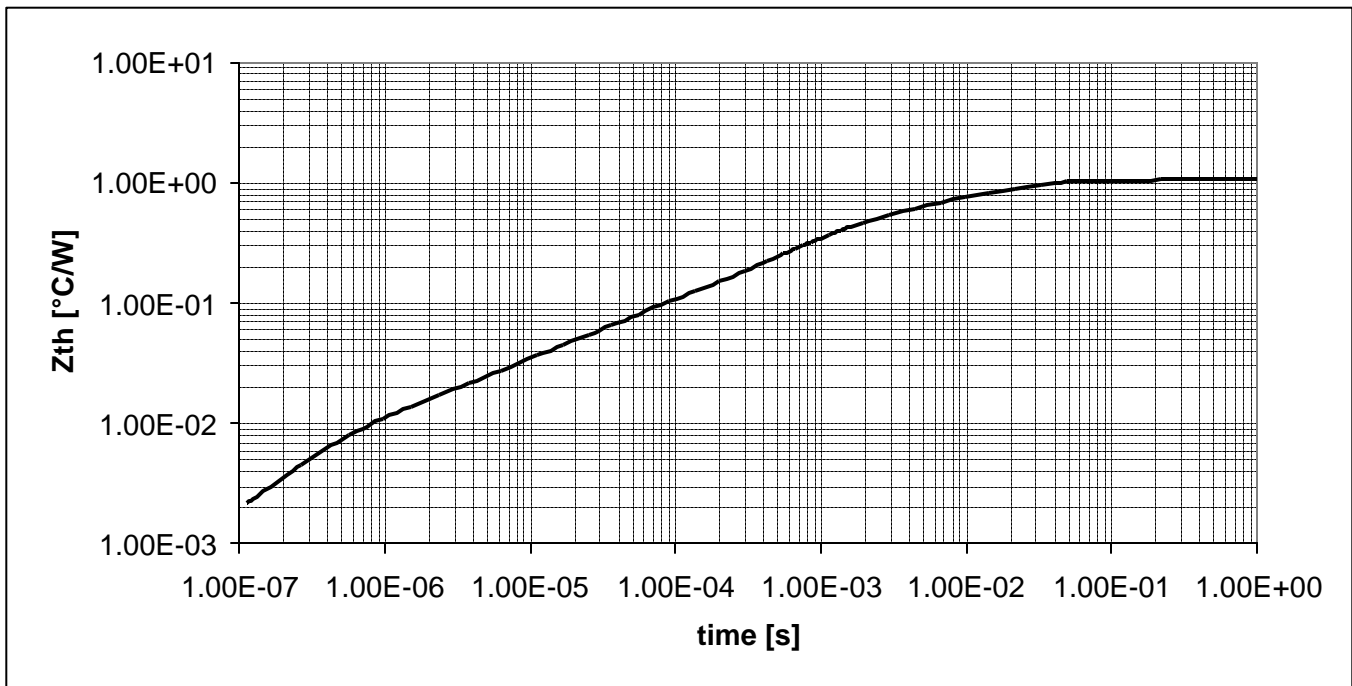
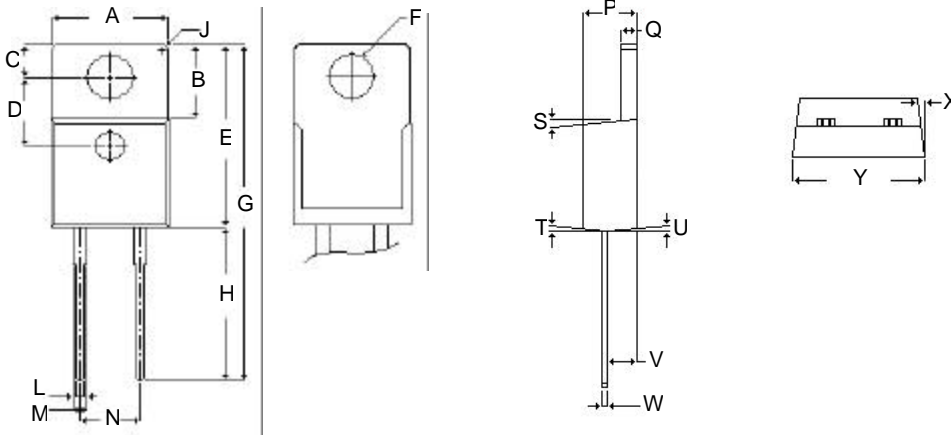

Figure 5. Transient Thermal Impedance



Package Dimensions

Package TO-220-2



POS	Inches		Millimeters	
	Min	Max	Min	Max
A	.381	.391	9.677	9.931
B	.240	.250	6.096	6.350
C	.100	.120	2.540	3.048
D	.223	.227	5.664	5.766
E	.595	.615	15.113	15.621
F	.143	.147	3.632	3.734
G	1.105	1.115	28.067	28.321
H	.500	.510	12.700	12.954
J	R 0.197		R 5.004	
L	.025	.035	.635	.889
M	.045	.055	1.143	1.397
N	.198	.202	5.029	5.131
P	.165	.185	4.191	4.699
Q	.048	.052	1.219	1.321
S	4°	6°	4°	6°
T	4°	6°	4°	6°
U	4°	6°	4°	6°
V	.094	.098	2.387	2.489
W	.018	.025	.458	.635
X	4.5°	5.5°	4.5°	5.5°
Y	.385	.405	9.779	10.287

NOTE:

1. Dimension L, M, W apply for Solder Dip Finish.

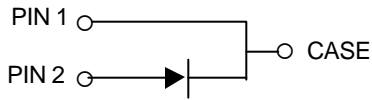

Part Number	Package	Marking
CSD05120A	TO-220-2	CSD05120

Cree, Inc.
Power Products
4600 Silicon Drive
Durham, NC 27703 • USA
tel: 919-313-5300
fax: 919-313-5451
www.cree.com

Copyright © 2001 Cree, Inc. All rights reserved.
Permission is given to reproduce this document provided the entire document (including this copyright notice) is duplicated.

The information in this document is subject to change without notice.

Cree and the Cree logo are trademarks of Cree, Inc.