

C&K V Series Power & Line Voltage Select Slide Switches

Features/Benefits

- Ratings up to 10 AMPS
- Snap-in panel and PC mounting
- Actuators with screwdriver slot
- Quick connect terminals available
- RoHS compliant

Typical Applications

- Appliances



Slide



Models Available

Specifications

CONTACT RATING: 10.1 AMPS @ 125 V AC; 4 AMPS @ 28 V DC; 5 AMPS @ 250 V AC (UL/CSA). 2.0 (0.5) AMPS @ 250 V AC, T85 (VDE).

ELECTRICAL LIFE: 10,000 make-and-break cycles at full load.

CONTACT RESISTANCE: Below 10 m Ω typ. initial @ 2-4 V DC, 100 mA.

INSULATION RESISTANCE: 10⁹ Ω min.

DIELECTRIC STRENGTH: 1,000 Vrms min. @ sea level.

OPERATING TEMPERATURE: -30°C to +85°C.

NOTE: Any models supplied with Q, B or G contact material are RoHS compliant. For the latest information regarding RoHS compliance, please go to: www.ittcannon.com/rohs.

NOTE: Specifications and materials listed above are for switches with standard options. For information on specific and custom switches, consult Customer Service Center.

Materials

HOUSING: 6/6 nylon (UL94V-2), black.

TOP PLATE: 6/6 nylon (UL94V-2), black.

ACTUATOR: Glass filled polyester (UL94V-0), '01 and 02' styles, black (standard); '12, 13 and 14' styles, red (standard).

CONTACTS: Copper, silver plated.

TERMINALS: Copper, silver plated.

CONTACT SPRING: Music wire or stainless steel.

TERMINAL SEAL: Epoxy.

Build-A-Switch

To order, simply select desired option from each category and place in the appropriate box. Available options are shown and described on pages J-33 through J-35. For additional options not shown in catalog, consult Customer Service Center.

<p>Switch Function</p> <p>V802 DPDT</p> <p>V701 SPST</p> <p>V702 SPDT</p> <p>V801 DPST</p>	<p>Actuator</p> <p>12 Screwdriver slot</p> <p>01 .290" high</p> <p>02 .290" high with markings</p> <p>13 Screwdriver slot</p> <p>14 Screwdriver slot with markings</p>	<p>Mounting Style</p> <p>SS Panel with mounting ears</p> <p>MA Right angle, PC thru-hole</p> <p>MS PC Thru-hole</p> <p>S2 Snap-in panel</p> <p>SL Right angle, panel with mounting ears</p>	<p>Terminations</p> <p>05 Quick connect</p> <p>02 PC thru-hole</p> <p>08 Right angle PC thru-hole</p>	<p>Contact Material</p> <p>Q Silver</p>	<p>Seal</p> <p>NONE No seal</p> <p>E Epoxy seal</p>
---	--	---	---	---	--



Dimensions are shown: Inch (mm)
Specifications and dimensions subject to change

C&K V Series Power & Line Voltage Select Slide Switches

SWITCH FUNCTION

NO. POLES	MODEL NO.	SWITCH FUNCTION	SCHEMATIC	AVAILABLE MOUNTING STYLES
SP	V701	SPST		ALL
	V702	SPDT		ALL

NO. POLES	MODEL NO.	SWITCH FUNCTION	SCHEMATIC	AVAILABLE MOUNTING STYLES
DP	V801	DPST		ALL
	V802	DPDT		ALL

All models with all options.
Contacts make on side actuator thrown.

ACTUATOR

12 SCREWDRIVER SLOT WITH MARKING

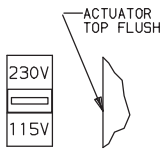

Actuator color is red with 115V-230V markings (std.).

01 .290" HIGH

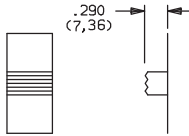

Actuator color is black.

02 .290" HIGH WITH MARKINGS

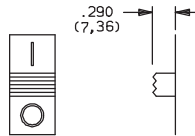

markings are reversed on V702 and V802 models. Actuator color is black with white markings (std.).

13 SCREWDRIVER SLOT NO MARKING

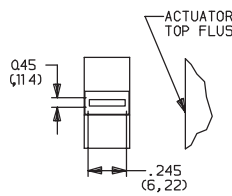

Actuator color is red.

14 SCREWDRIVER SLOT WITH MARKINGS

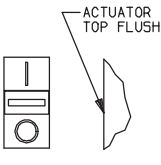

Markings are reversed on V702 and V802 models. Actuator color is red with white markings (std.).

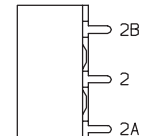

Note: Orientation of actuator markings and terminals.

MOUNTING STYLE

SS PANEL WITH MOUNTING EARS



V80212SS05Q
DPDT

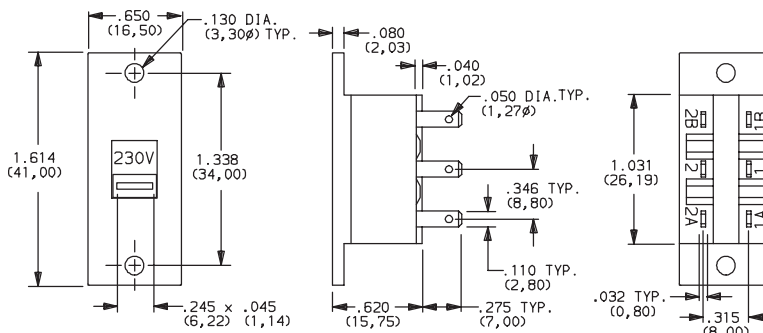

PANEL MOUNTING

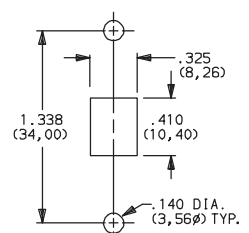

AVAILABLE WITH:
Models: All.
Terminations: 02 and 05

MA RIGHT ANGLE, PC THRU-HOLE



V80212MA08Q
Horizontal Actuation
DPDT

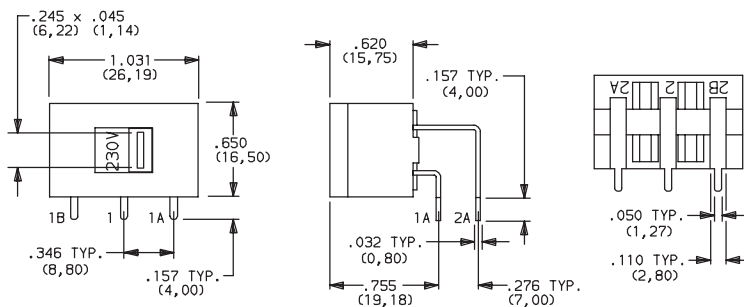

AVAILABLE WITH:

Models: All
Terminations: 08

PC MOUNTING

PC mount, side actuated.
For mounting information, see TERMINATIONS section, page J-35.



Dimensions are shown: Inch (mm)
Specifications and dimensions subject to change

Slide

C&K V Series Power & Line Voltage Select Slide Switches

MOUNTING STYLE

MS PC THRU-HOLE

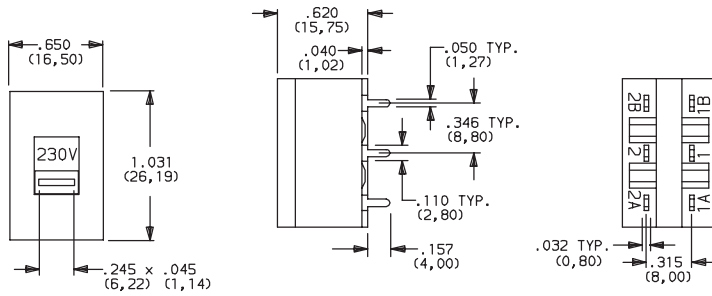

AVAILABLE WITH:
All models with 02 terminations

PC MOUNTING
PC mount, top actuated.
For mounting information,
see TERMINATIONS section, page J-35.



V80212MS02Q
DPDT

Slide

SL RIGHT ANGLE PANEL WITH MOUNTING EARS

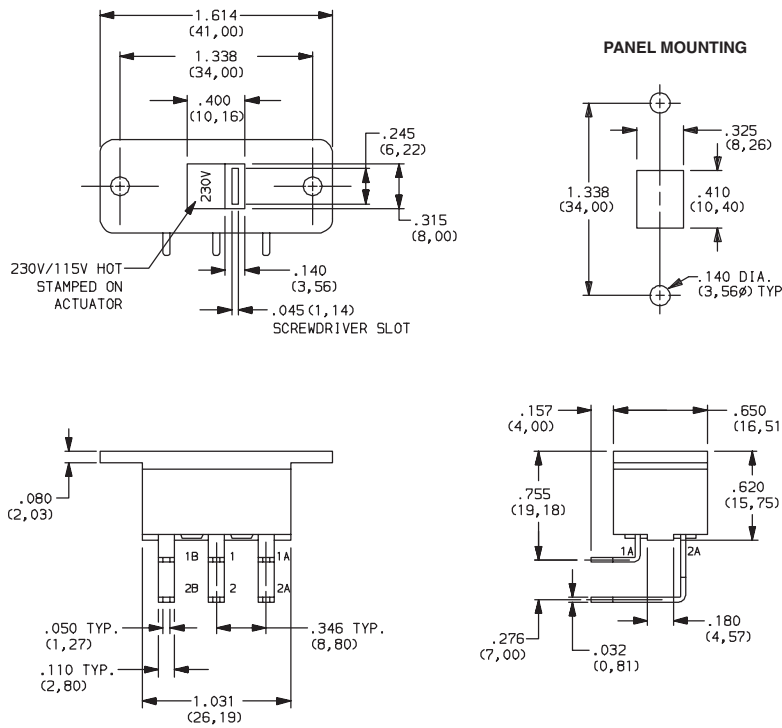

AVAILABLE WITH:
All models with 08 terminations



V80213SL08Q
Horizontal Actuation
DPDT

S2 SNAP-IN PANEL MOUNT

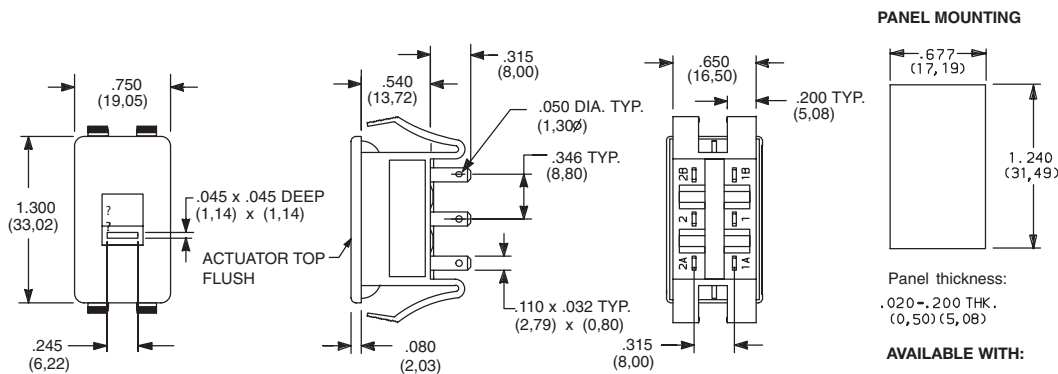

PANEL MOUNTING

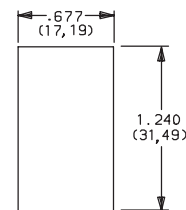

Panel thickness:
.020-.200 THK.
(0,50) (5,08)

AVAILABLE WITH:
All models with 02 &
05 terminations



V80212S205Q
DPDT

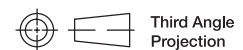

Dimensions are shown: Inch (mm)
Specifications and dimensions subject to change

C&K V Series Power & Line Voltage Select Slide Switches

TERMINATIONS

05 QUICK CONNECT

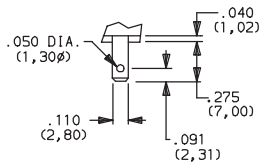

.032 THK.
(0,80)

Fits .110 in. quick connector.

02 PC THRU-HOLE

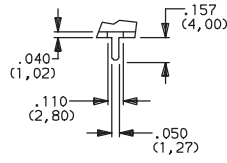

.032 THK.
(0,80)

PC MOUNTING

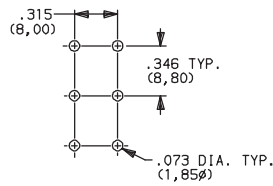

MSt SS Mounting Styles

08 PC THRU-HOLE

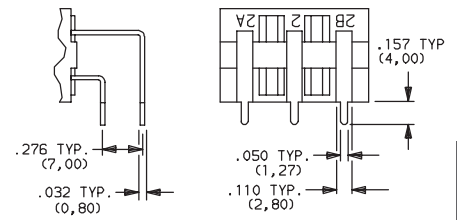

Not available with 'MS, SS or S2' mounting styles.

PC MOUNTING

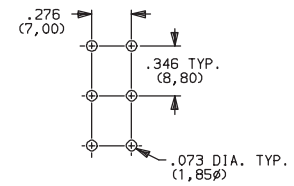

MAI SL Mounting Styles

CONTACT MATERIAL

OPTION CODE	RoHS COMPLIANT	RoHS COMPLIANT	CONTACT MATERIAL	RATINGS	
Q	YES	YES	SILVER ¹	POWER	10.1 AMPS @ 125 V AC; 4 AMPS @ 28 V DC; 5 AMPS @ 250 V AC (UL/CSA); 2.0 (0.5) AMPS @ 250 V AC, T85 (VDE).

* Note: See Technical Data section of this catalog for RoHS compliant and compatible definitions and specifications.

¹ CONTACTS & TERMINALS: Copper, silver plated (standard with all termination options).

All models with all options. V70X and V80X models .

NOTE: Any models supplied with Q contact material are RoHS compliant. For the latest information regarding RoHS compliance, please go to: www.ittcannon.com/rohs.

SEAL

NONE NO SEAL

E EPOXY SEAL

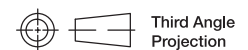
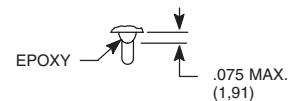

Dimensions are shown: Inch (mm)
Specifications and dimensions subject to change



Slide