

AG503-86

InGaP HBT Gain Block

Product Information



Product Features

- DC – 6000 MHz
- +16 dBm P1dB at 900 MHz
- +29 dBm OIP3 at 900 MHz
- 20 dB Gain at 900 MHz
- Single Voltage Supply
- Green SOT-86 SMT Package
- Internally matched to 50 Ω

Applications

- Mobile Infrastructure
- CATV / DBS
- W-LAN / ISM
- RFID
- Defense / Homeland Security
- Fixed Wireless

Product Description

The AG503-86 is a general-purpose buffer amplifier that offers high dynamic range in a low-cost surface-mount package. At 900 MHz, the AG503-86 typically provides 20 dB gain, +29 dBm OIP3, and +16 dBm P1dB. The device combines dependable performance with consistent quality to maintain MTTF values exceeding 100 years at mounting temperatures of +85 °C & is housed in a SOT-86 (micro-X) industry-standard SMT lead-free/green/RoHS-compliant package.

The AG503-86 consists of Darlington pair amplifiers using the high reliability InGaP/GaAs HBT process technology and only requires DC-blocking capacitors, a bias resistor, and an inductive RF choke for operation.

The broadband MMIC amplifier can be directly applied to various current and next generation wireless technologies such as GPRS, GSM, CDMA, and W-CDMA. In addition, the AG503-86 will work for other various applications within the DC to 6 GHz frequency range such as CATV and fixed wireless.

Functional Diagram

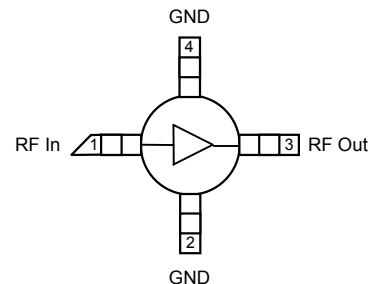

| Function | Pin No. |
|-------------|---------|
| Input | 1 |
| Output/Bias | 3 |
| Ground | 2, 4 |

Specifications ⁽¹⁾

| Parameter | Units | Min | Typ | Max |
|---------------------------|-------|------|-------|------|
| Operational Bandwidth | MHz | DC | | 6000 |
| Test Frequency | MHz | | 900 | |
| Gain | dB | | 15.6 | |
| Input Return Loss | dB | | 20 | |
| Output Return Loss | dB | | 18 | |
| Output IP3 ⁽²⁾ | dBm | | +25.9 | |
| Output IP2 | dBm | | +37 | |
| Output P1dB | dBm | | +13.5 | |
| Noise Figure | dB | | 3.2 | |
| Test Frequency | MHz | | 1900 | |
| Gain | dB | 13.3 | 14.3 | 15.3 |
| Output IP3 ⁽²⁾ | dBm | | +25.0 | |
| Output P1dB | dBm | | +12.2 | |
| Device Voltage | V | | 5.0 | |
| Device Current | mA | | 45 | |

1. Test conditions: T = 25° C, Supply Voltage = +6 V, R_{bias} = 22.1 Ω, 50 Ω System.
2. 3OIP measured with two tones at an output power of 0 dBm/tone separated by 10 MHz. The suppression on the largest IM3 product is used to calculate the 3OIP using a 2:1 rule.
3. The junction temperature ensures a minimum MTTF rating of 1 million hours of usage.

Typical Performance ⁽¹⁾

| Parameter | Units | Typical | | | |
|--------------|-------|---------|-------|-------|-------|
| Frequency | MHz | 500 | 900 | 1900 | 2140 |
| S21 | dB | 16.0 | 15.6 | 14.3 | 14.0 |
| S11 | dB | -19 | -20 | -21 | -25 |
| S22 | dB | -21 | -18 | -13 | -12 |
| Output P1dB | dBm | +13.3 | +13.5 | +12.2 | +11.7 |
| Output IP3 | dBm | +26.4 | +25.9 | +25.0 | +24.3 |
| Noise Figure | dB | 3.2 | 3.2 | 3.4 | 3.4 |

Absolute Maximum Rating

| Parameter | Rating |
|-----------------------------|----------------|
| Operating Case Temperature | -40 to +85 °C |
| Storage Temperature | -55 to +125 °C |
| DC Voltage | +5.8 V |
| RF Input Power (continuous) | +10 dBm |
| Junction Temperature | +250° C |

Operation of this device above any of these parameters may cause permanent damage

Ordering Information

| Part No. | Description |
|-------------|---|
| AG503-86* | InGaP HBT Gain Block (lead-tin SOT-86 Pkg) |
| AG503-86G | InGaP HBT Gain Block (lead-free/green/RoHS-compliant SOT-86 Pkg) |
| AG503-86PCB | 700 – 2400 MHz Fully Assembled Eval. Board |

* This package is being phased out in favor of the green package type which is backwards compatible for existing designs. Refer to Product Change Notification WJPCN06MAY05TC1 on the WJ website.

Specifications and information are subject to change without notice



Typical Device RF Performance

Supply Bias = 6 V, $R_{bias} = 22.1 \Omega$, $I_{cc} = 45 \text{ mA}$

| Frequency | MHz | 100 | 500 | 900 | 1900 | 2140 | 2400 | 3500 | 5800 |
|--------------|-----|-------|-------|-------|-------|-------|-------|-------|------|
| S21 | dB | 21.0 | 20.8 | 20.2 | 17.8 | 17.6 | 17.2 | 15.3 | 11.8 |
| S11 | dB | -20 | -20 | -20 | -18 | -18 | -18 | -20 | -20 |
| S22 | dB | -18 | -21 | -20 | -15 | -13 | -13 | -16 | -14 |
| Output P1dB | dBm | +16.2 | +16.0 | +15.9 | +14.6 | +14.3 | +14.0 | +11.0 | |
| Output IP3 | dBm | +28.9 | +28.9 | +28.8 | +27.8 | +27.4 | +27.0 | +24.4 | |
| Noise Figure | dB | 2.9 | 2.9 | 2.9 | 3.1 | 3.1 | 3.2 | | |

1. Test conditions: T = 25° C, Supply Voltage = +6 V, Device Voltage = 6.0 V, $R_{bias} = 22.1 \Omega$, $I_{cc} = 45 \text{ mA}$ typical, 50 Ω System.
2. 3OIP measured with two tones at an output power of 0 dBm/tone separated by 10 MHz. The suppression on the largest IM3 product is used to calculate the 3OIP using a 2:1 rule.
3. Data is shown as device performance only. Actual implementation for the desired frequency band will be determined by external components shown in the application circuit.

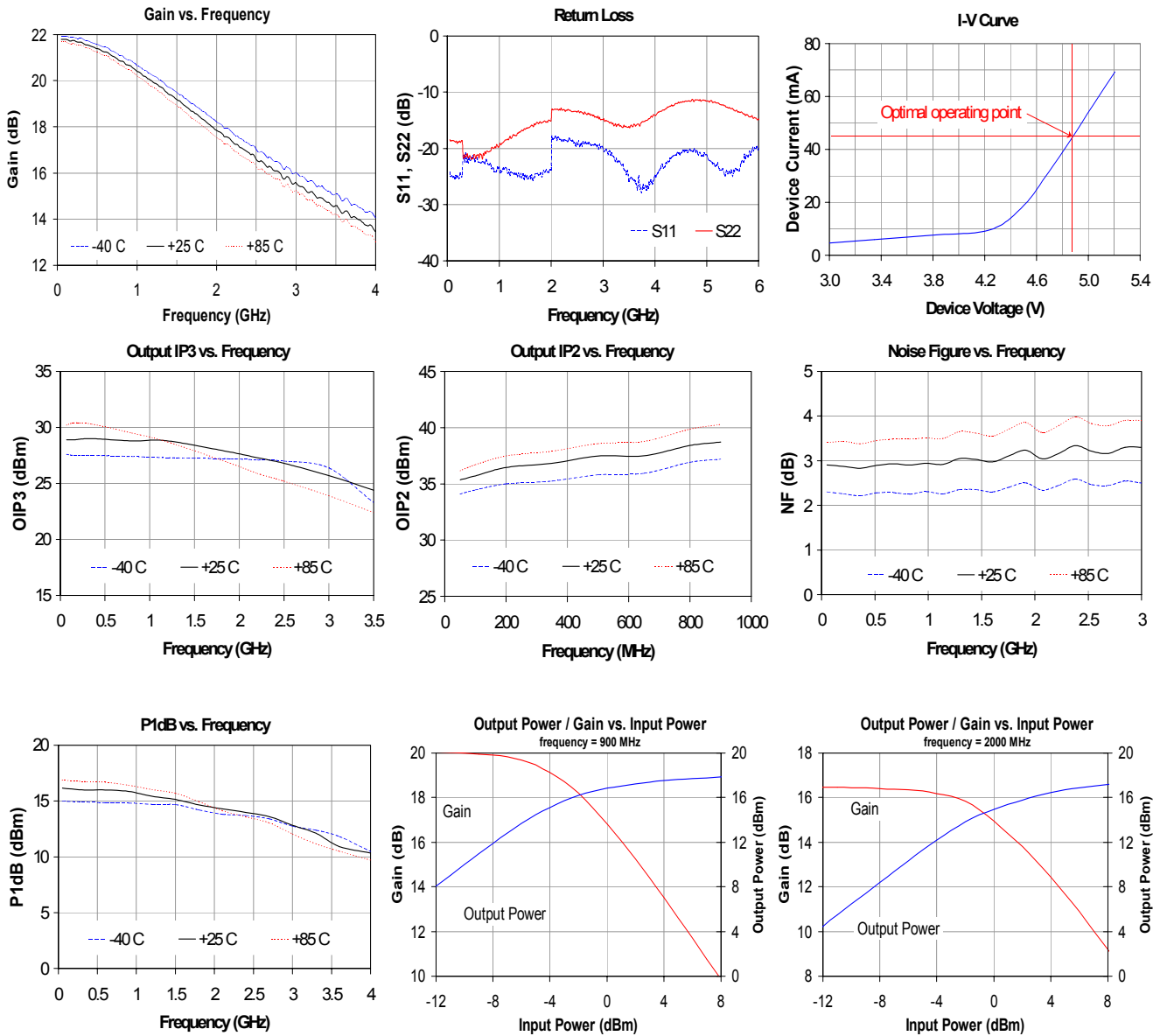



Typical Device RF Performance

Supply Bias = +8 V, R_{bias} = 44 Ω, I_{cc} = 45 mA

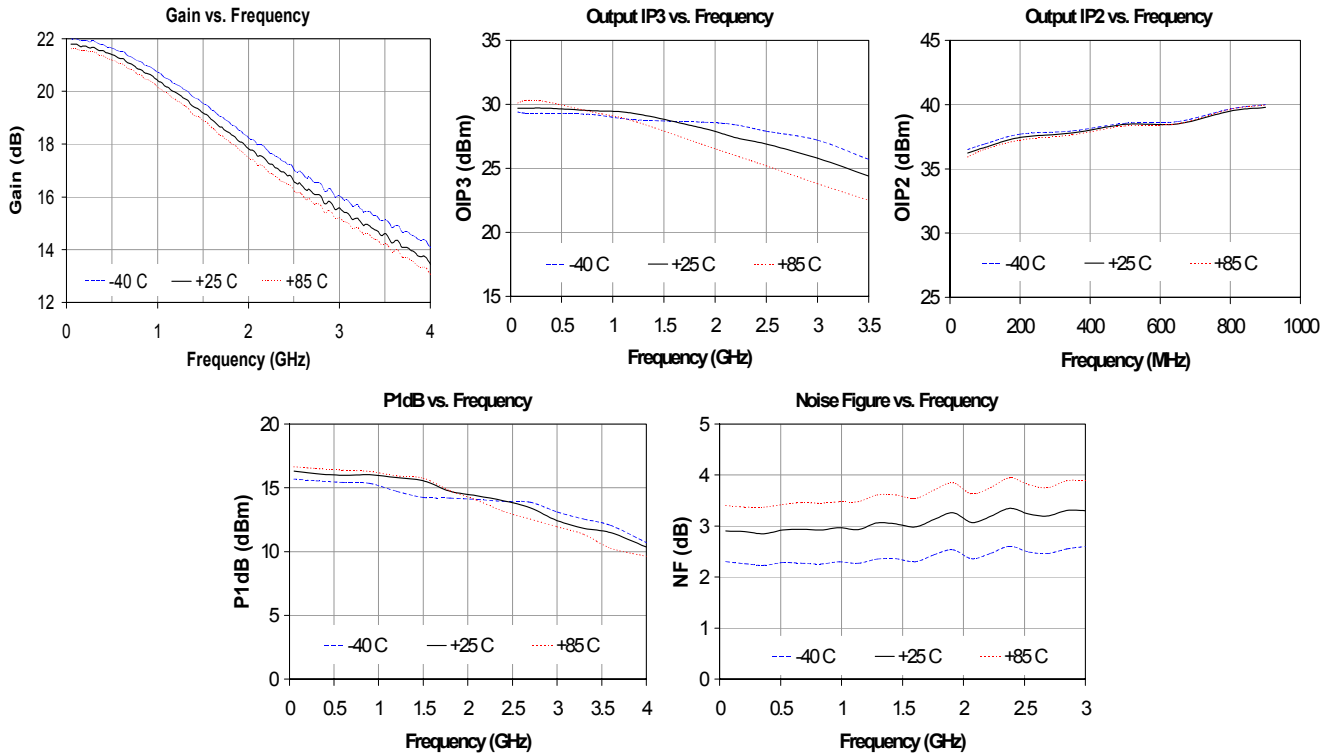

Application Circuit

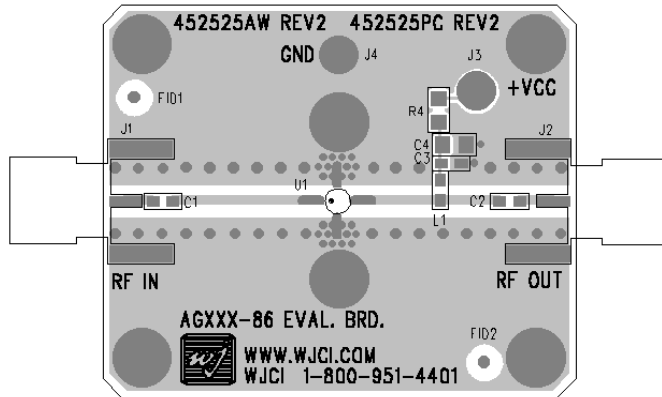
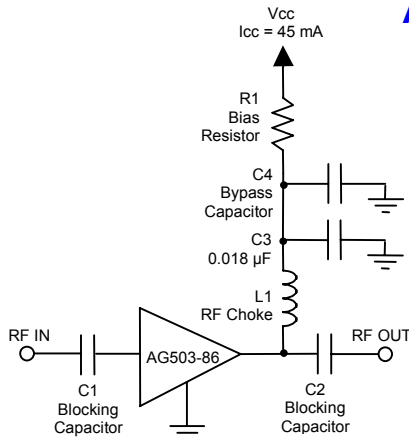

Recommended Component Values

| Reference Designator | Frequency (MHz) | | | | | | |
|----------------------|-----------------|---------|--------|-------|-------|-------|-------|
| | 50 | 500 | 900 | 1900 | 2200 | 2500 | 3500 |
| L1 | 820 nH | 220 nH | 68 nH | 27 nH | 22 nH | 18 nH | 15 nH |
| C1, C2, C4 | .018 μF | 1000 pF | 100 pF | 68 pF | 68 pF | 56 pF | 39 pF |

- The proper values for the components are dependent upon the intended frequency of operation.
- The following values are contained on the evaluation board to achieve optimal broadband performance:

| Ref. Desig. | Value / Type | Size |
|-------------|--------------------------|------|
| L1 | 39 nH wirewound inductor | 0603 |
| C1, C2 | 56 pF chip capacitor | 0603 |
| C3 | 0.018 μF chip capacitor | 0603 |
| C4 | Do Not Place | |
| R1 | 22.1 Ω 1% tolerance | 0805 |

Recommended Bias Resistor Values

| Supply Voltage | R1 value | Size |
|----------------|-----------|------|
| 6 V | 22.2 ohms | 0603 |
| 7 V | 44.4 ohms | 0805 |
| 8 V | 67 ohms | 1206 |
| 9 V | 89 ohms | 1210 |
| 10 V | 111 ohms | 1210 |
| 12 V | 156 ohms | 2010 |

The proper value for R1 is dependent upon the supply voltage and allows for bias stability over temperature. WJ recommends a minimum supply bias of +6 V. A 1% tolerance resistor is recommended.

Specifications and information are subject to change without notice

AG503-86

InGaP HBT Gain Block

Product Information



Typical Device Data

S-Parameters ($V_{\text{device}} = +5.0 \text{ V}$, $I_{\text{CC}} = 45 \text{ mA}$, $T = 25^\circ \text{ C}$, calibrated to device leads)

| Freq (MHz) | S11 (dB) | S11 (ang) | S21 (dB) | S21 (ang) | S12 (dB) | S12 (ang) | S22 (dB) | S22 (ang) |
|------------|----------|-----------|----------|-----------|----------|-----------|----------|-----------|
| 50 | -24.44 | -177.67 | 21.67 | 177.30 | -24.34 | 2.97 | -18.52 | -7.18 |
| 250 | -24.44 | 164.30 | 21.57 | 167.09 | -24.61 | 2.48 | -18.86 | -18.94 |
| 500 | -21.37 | 149.15 | 21.36 | 154.27 | -24.79 | -1.41 | -21.64 | -48.63 |
| 750 | -22.01 | 133.61 | 21.04 | 142.18 | -24.91 | -0.76 | -20.64 | -72.70 |
| 1000 | -23.48 | 111.38 | 20.63 | 130.59 | -24.93 | -5.89 | -19.50 | -92.91 |
| 1250 | -24.31 | 89.71 | 20.18 | 119.26 | -24.48 | -3.85 | -17.89 | -109.14 |
| 1500 | -24.81 | 65.41 | 19.65 | 108.86 | -24.13 | -2.88 | -16.59 | -119.24 |
| 1750 | -24.63 | 32.83 | 19.10 | 98.96 | -24.32 | -3.45 | -15.53 | -126.61 |
| 2000 | -22.62 | 10.74 | 18.53 | 89.57 | -23.97 | -4.87 | -14.85 | -133.04 |
| 2250 | -18.50 | 0.24 | 17.98 | 81.21 | -23.53 | -6.73 | -13.12 | -125.47 |
| 2500 | -19.01 | -8.16 | 17.60 | 74.79 | -23.67 | -9.19 | -13.52 | -132.23 |
| 2750 | -19.23 | -16.02 | 17.14 | 66.16 | -23.22 | -10.70 | -14.01 | -142.18 |
| 3000 | -19.99 | -20.82 | 16.72 | 58.14 | -22.51 | -11.38 | -14.84 | -155.04 |
| 3250 | -22.01 | -18.24 | 16.29 | 50.34 | -22.50 | -13.34 | -15.91 | -172.38 |
| 3500 | -25.77 | -3.66 | 15.88 | 42.45 | -22.27 | -15.84 | -16.13 | 164.34 |
| 3750 | -27.43 | 33.78 | 15.42 | 34.38 | -21.77 | -19.50 | -15.28 | 139.30 |
| 4000 | -24.77 | 70.07 | 14.98 | 26.44 | -21.57 | -22.70 | -14.12 | 122.06 |
| 4250 | -22.30 | 85.66 | 14.56 | 18.90 | -20.99 | -25.24 | -12.66 | 109.74 |
| 4500 | -20.80 | 92.93 | 14.09 | 11.59 | -20.84 | -28.83 | -11.77 | 102.11 |
| 4750 | -20.29 | 102.02 | 13.71 | 4.12 | -20.73 | -32.26 | -11.62 | 97.84 |
| 5000 | -21.16 | 110.99 | 13.39 | -2.78 | -20.46 | -36.07 | -11.55 | 96.81 |
| 5250 | -23.80 | 134.38 | 13.03 | -9.23 | -20.21 | -39.85 | -12.15 | 98.05 |
| 5500 | -24.99 | 172.16 | 12.69 | -15.58 | -19.97 | -41.39 | -12.91 | 101.46 |
| 5750 | -21.56 | -154.26 | 12.47 | -22.34 | -19.50 | -44.82 | -14.07 | 107.85 |
| 6000 | -20.00 | -137.16 | 12.19 | -28.69 | -19.34 | -49.46 | -14.74 | 111.53 |

Device S-parameters are available for download off of the website at: <http://www.wj.com>

AG503-86

InGaP HBT Gain Block

Product Information



AG503-86 (SOT-86 Package) Mechanical Information

This package may contain lead-bearing materials. The plating material on the leads is SnPb.

Outline Drawing

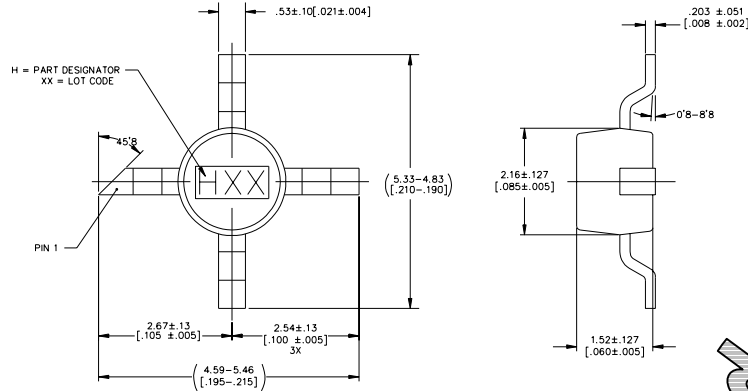

Product Marking

The component will be marked with an "H" designator, followed by a two-digit numeric lot code on the top surface of the package.

Order and res. (modification) of this part are located on the website under "Application Notes" section.

MSL / ESD Rating

Warning! ESD sensitive device.

ESD Rating: Class 0
 Passes at 150 V
 Human Body Model (HBM)
 Standard: JEDEC Standard JESD22-A114

ESD Rating: Class II
 Value: Passes at 250 V
 Test: Charged Device Model (CDM)
 Standard: JEDEC Standard JESD22-C101

MSL Rating: Level 1
 Standard: JEDEC Standard J-STD-020A

Land Pattern

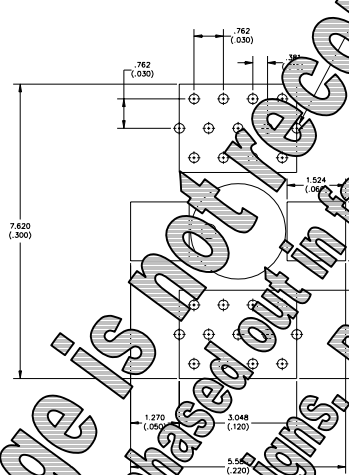

Thermal Specifications

| Parameter | Rating |
|--|--------------|
| Operating Case Temperature | -40 to 85 °C |
| Thermal Resistance, R _{th(j-c)} | 1.5 °C/W |
| Junction Operating Temperature (2) | 177 °C |

1. The thermal resistance is referenced from the hottest part of the junction to the ground pad (pin 2 or 4).
 2. The value corresponds to the normal biasing condition of 100mW, 0.3V, 100mA at an 85 °C case temperature. A minimum MTBF of one million hours is achieved for junction temperatures below 177 °C.

Mounting Config. Notes

- Ground / thermal vias are critical for the proper performance of this device. Vias should use a .35mm (#80 / .0135") diameter drill and have a final plated thru diameter of .25 mm (.010").
- Add as much copper as possible to inner and outer layers near the part to ensure optimal thermal performance.
- Mounting screws can be added near the part to fasten the board to a heatsink. Ensure that the ground / thermal via region contacts the heatsink.
- Do not put solder mask on the backside of the PC board in the region where the board contacts the heatsink.
- RF trace width depends upon the PC board material and construction.
- Use 1 oz. Copper minimum.
- All dimensions are in millimeters (inches). Angles are in degrees.

Specifications and information are subject to change without notice

AG503-86

InGaP HBT Gain Block

Product Information



AG503-86G (Green / Lead-free Sot-86 Package) Mechanical Information

This package is lead-free/Green/RoHS-compliant. It is compatible with both lead-free (maximum 260°C reflow temperature) and leaded (maximum 245°C reflow temperature) soldering processes. The plating material on the pins is annealed matte tin over copper.

Outline Drawing

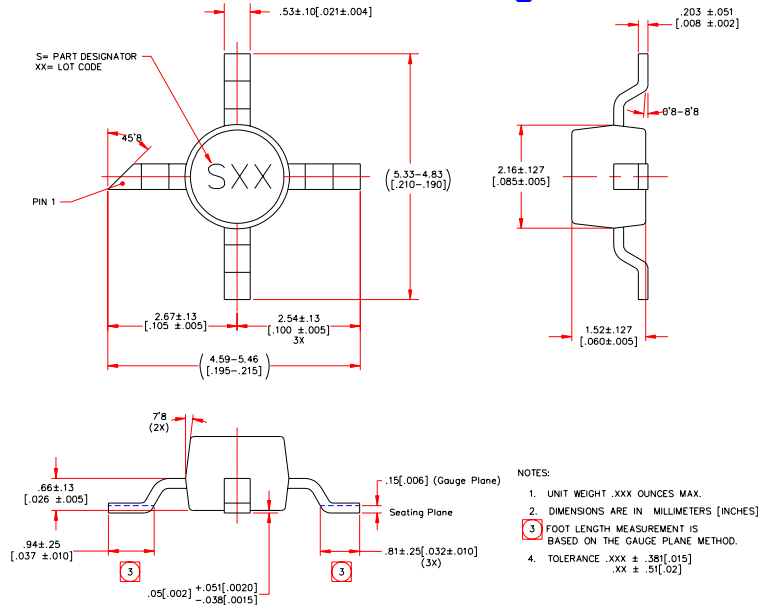

Land Pattern

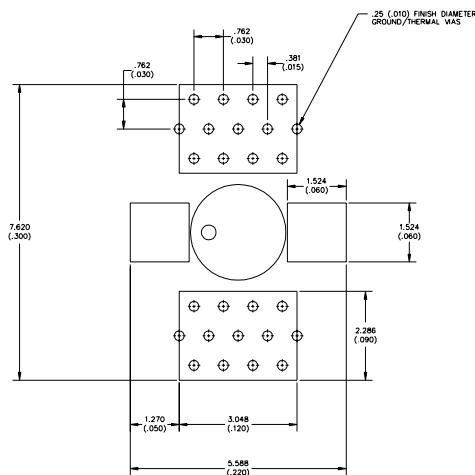

Product Marking

The component will be marked with an “S” designator followed by a two-digit numeric lot code on the top surface of the package.

Tape and reel specifications for this part are located on the website in the “Application Notes” section.

MSL / ESD Rating



Caution! ESD sensitive device.

ESD Rating: Class 1C
 Value: Passes at 1000 V min.
 Test: Human Body Model (HBM)
 Standard: JEDEC Standard JESD22-A114

ESD Rating: Class IV
 Value: Passes at 1000 V min.
 Test: Charged Device Model (CDM)
 Standard: JEDEC Standard JESD22-C101

MSL Rating: Level 3 at +260° C convection reflow
 Standard: JEDEC Standard J-STD-020

Mounting Config. Notes

- Ground / thermal vias are critical for the proper performance of this device. Vias should use a .35mm (#80 / .0135”) diameter drill and have a final plated thru diameter of .25 mm (.010”).
- Add as much copper as possible to inner and outer layers near the part to ensure optimal thermal performance.
- Mounting screws can be added near the part to fasten the board to a heatsink. Ensure that the ground / thermal via region contacts the heatsink.
- Do not put solder mask on the backside of the PC board in the region where the board contacts the heatsink.
- RF trace width depends upon the PC board material and construction.
- Use 1 oz. Copper minimum.
- All dimensions are in millimeters (inches). Angles are in degrees.

Thermal Specifications

| Parameter | Rating |
|--|---------------|
| Operating Case Temperature | -40 to +85 °C |
| Thermal Resistance, Rth ⁽¹⁾ | 257 °C/W |
| Junction Temperature, Tjc ⁽²⁾ | 143 °C |

- The thermal resistance is referenced from the hottest part of the junction to the ground lead (pin 2 or 4).
- This corresponds to the typical biasing condition of +5.03V, 45 mA at an 85 °C case temperature. A minimum MTTF of 1 million hours is achieved for junction temperatures below 177 °C.

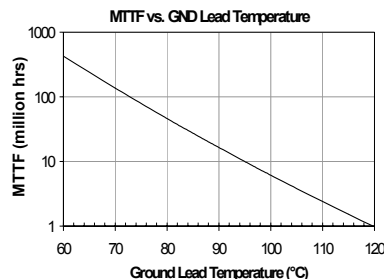

Specifications and information are subject to change without notice