

Features

- Low Quiescent Current : 60 μ A (No load)
- Low Dropout Voltage : 700mV (@700mA)
- Very low Shutdown Current : < 0.5 μ A
- Fixed Output Voltage : 1.5V ~ 3.5V by step 0.1V increment
- Stable with 2.2 μ F Output Capacitor
- Stable with Aluminum, Tantalum or Ceramic Capacitors .
- No Protection Diodes Needed
- Built in Thermal Protection
- Built in Current Limit Protection
- Controlled Short Circuit Current : 50mA
- Fast Transient Response
- Short Setting Time
- SOT-223 Package
- Lead Free Available (RoHS Compliant)

Applications

- 5V to 3.3~3.5V Linear Regulators
- 3.3V to 1.5~2.5V Linear Regulators
- CD-R/W, DVD Player
- LAN Card, ADSL/Cable Modem
- Computers

General Description

The APL5708R series are micropower, low dropout linear regulators, which operate from 2.7V to 6V input voltage and deliver up to 700mA. Typical dropout voltage is only 700mV at 700mA loading. Designed for using in battery-powered system, the low 60 μ A quiescent current makes it an ideal choice. Design with an internal P-channel MOSFET pass transistor, the APL5708R maintain a low supply current, independent of the load current and dropout voltage. Other features include thermal-shutdown protection, current limit protection to ensure specified output current and controlled short-circuit current. The APL5708R regulators come in a miniature SOT-223 package.

Pin Configuration

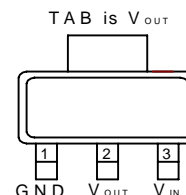

SOT-223 (Top View)

APL5708R

Ordering and Marking Information

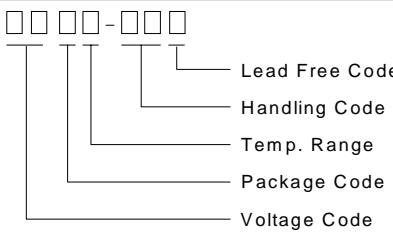
<p>APL5708R - - </p>  <p>Lead Free Code Handling Code Temp. Range Package Code Voltage Code</p>	<p>Package Code V : SOT-223 Temp. Range C : 0 to 70°C Handling Code TR : Tape & Reel Voltage Code : 15 : 1.5V ~ 35 : 3.5V Lead Free Code L : Lead Free Devcie Blank : Original Device</p>
<p>APL5708R -15 V : APL5708R XXXXX15</p>	<p>XXXXX - Date Code ; 15 - 1.5V</p>

Notes: ANPEC lead-free products contain molding compounds/die attach materials and 100% matte in plate termination finish; which are fully compliant with RoHS and compatible with both SnPb and lead-free soldering operations. ANPEC lead-free products meet or exceed the lead-free requirements of IPC/JEDEC J STD-020C for MSL classification at lead-free peak reflow temperature.

Pin Description

PIN		I/O	Description
No.	Name		
1	GND		Ground pins of the circuitry.
2	V _{OUT}	O	Output pin of the regulator.
3	V _{IN}	I	Supply voltage input.

Absolute Maximum Ratings

Symbol	Parameter	Rating	Unit
V _{IN} , V _{OUT}	Input Voltage or Out Voltage	6	V
R _{TH,JA}	Thermal Resistance – Junction to Ambient	135	°C/W
P _D	Power Dissipation	Internally Limited	W
T _J	Operating Junction Temperature		°C
	Control Section	0 to 125	
	Power Transistor	0 to 150	
T _{STG}	Storage Temperature Range	-65 to +150	°C
T _L	Lead Temperature (Soldering, 10 second)	260	°C

Electrical Characteristics

Unless otherwise noted these specifications apply over full temperature, $C_{IN}=1\mu F$, $C_{OUT}=2.2\mu F$, $T_J=0$ to $125^\circ C$. Typical values refer to $T_J=25^\circ C$.

Symbol	Parameter	Test Conditions	APL5708R			Unit
			Min.	Typ.	Max.	
V_{IN}	Input Voltage		2.7		6	V
V_{OUT}	Output Voltage	$V_{OUT}+1.0V < V_{CC} < 6.0V$, $0mA < I_{OUT} <$	$V_{OUT}-2\%$	V_{OUT}	$V_{OUT}+2\%$	V
I_{LIMIT}	Circuit Current Limit	$V_{IN}=V_{OUT}+1V$		900		mA
I_{SHORT}	Short Current	$V_{OUT}=0V$		50		mA
I_{OUT}	Load Current	$V_{IN}=V_{OUT}+1V$	700			mA
REG_{LINE}	Line Regulation	$V_{OUT}+1V < V_{CC} < 6.0V$, $I_{OUT}=1mA$		1	10	mV
REG_{LOAD}	Load Regulation	$V_{IN}=V_{OUT}+1V$, $0mA < I_{OUT} < I_{MAX}$		25	40	mV
	Load Transient	$V_{IN}=V_{OUT}+1V$, $I_{OUT}=1mA-700mA$ in $1\mu s$		150	250	mV
V_{DROP}	Dropout Voltage ^(Note1)	$I_{OUT}=700mA$	$1.5V \leq V_{OUT} < 2.0V$	1.1	1.3	V
			$2.0V \leq V_{OUT} < 2.5V$	0.9	1.0	
			$2.5V \leq V_{OUT} < 3V$	0.8	0.9	
			$3V \leq V_{OUT} \leq 3.5V$	0.7	0.8	
$PSRR$	Ripple Rejection	$F \leq 1kHz$, $1V_{pp}$ at $V_{IN}=V_{OUT}+1.0V$	45	55		dB
I_Q	Quiescent Current	No load		60	100	μA
		$I_{OUT}=700mA$		450	500	
OTS	Over Temperature Shutdown			150		$^\circ C$
	Over Temperature Shutdown Hysteresis	Hysteresis		30		$^\circ C$
TC	Output Voltage Temperature Coefficient			50		ppm/ $^\circ C$
C_{OUT}	Output Capacitor			2.2		μF
	ESR		0.01	0.1	1	Ohm

Note1: Dropout voltage definition: $V_{IN} - V_{OUT}$ when V_{OUT} is 2% below the value of V_{OUT} for $V_{IN} = V_{OUT} + 1V$.

Application Circuit

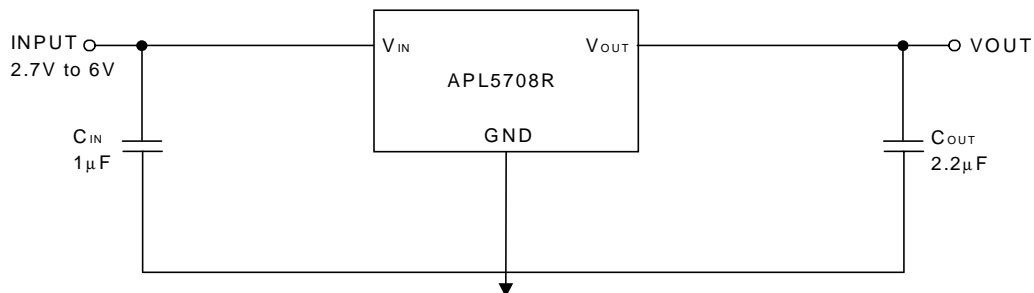

Typical Characteristics

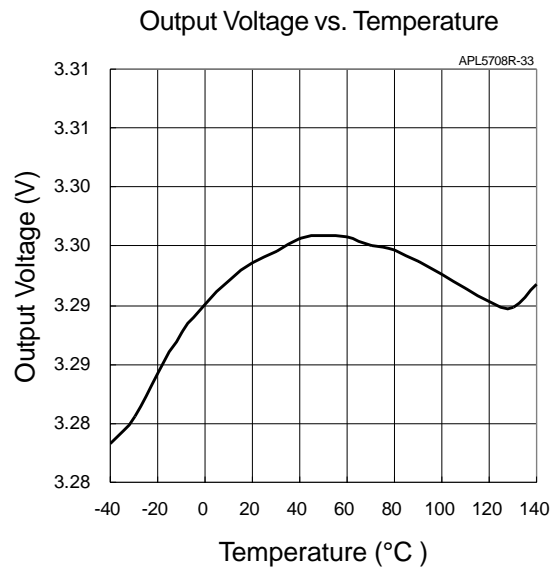
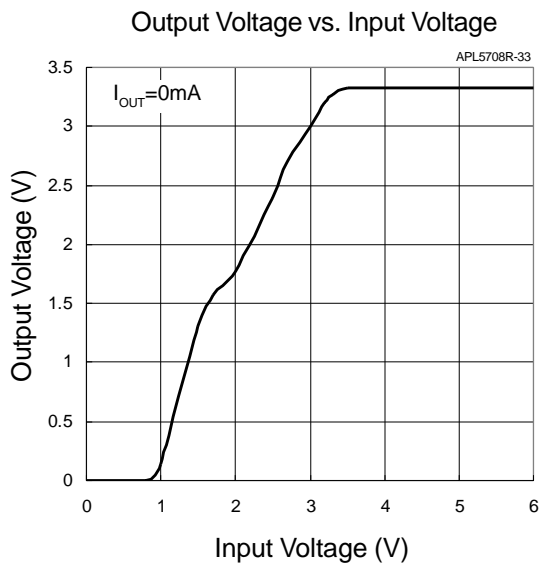
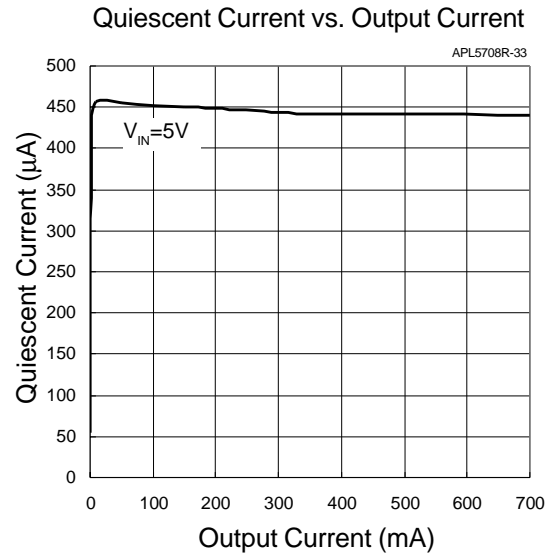
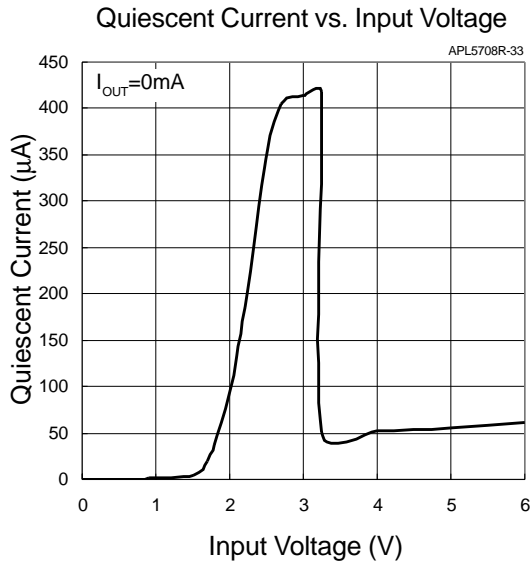

Typical Characteristics

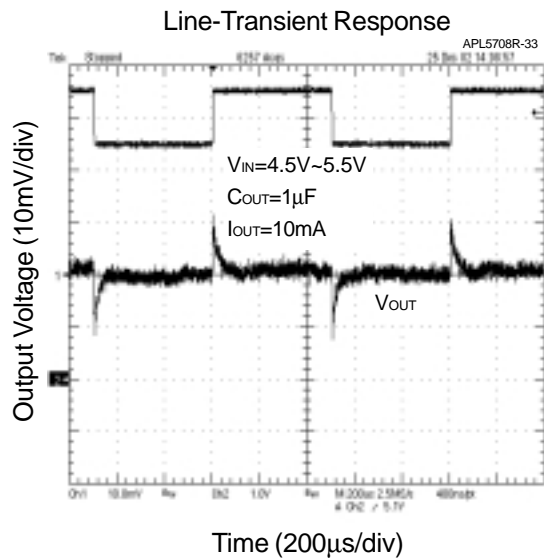
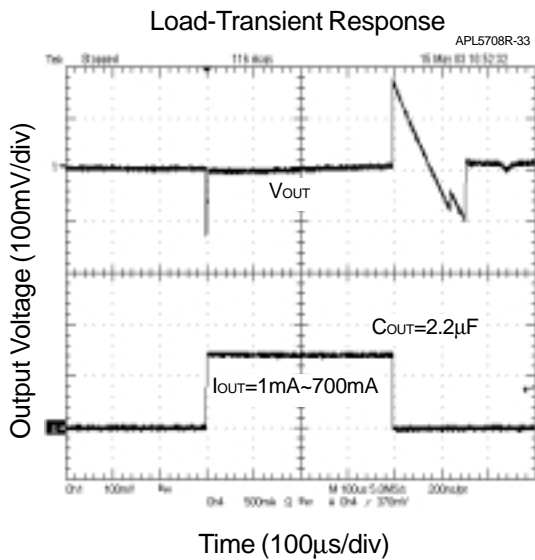
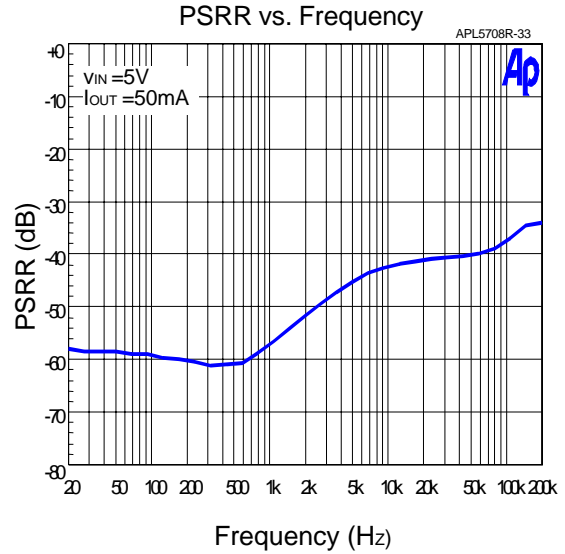
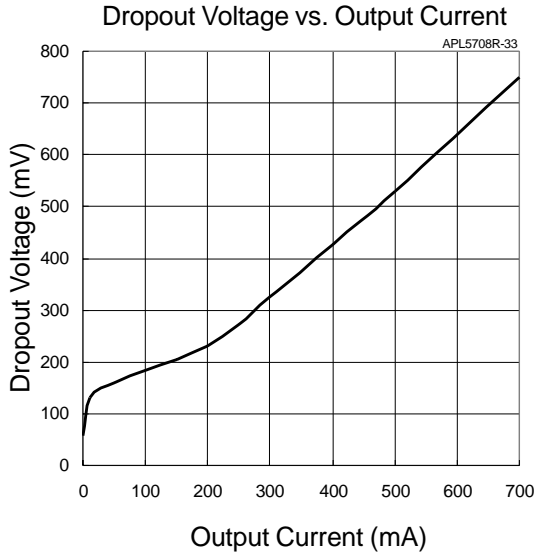

Typical Characteristics

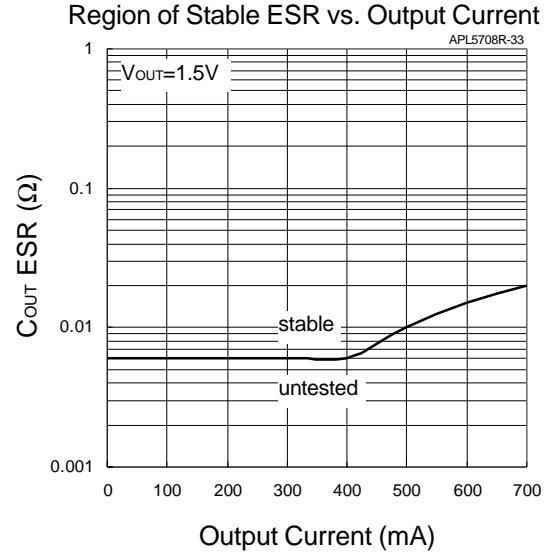
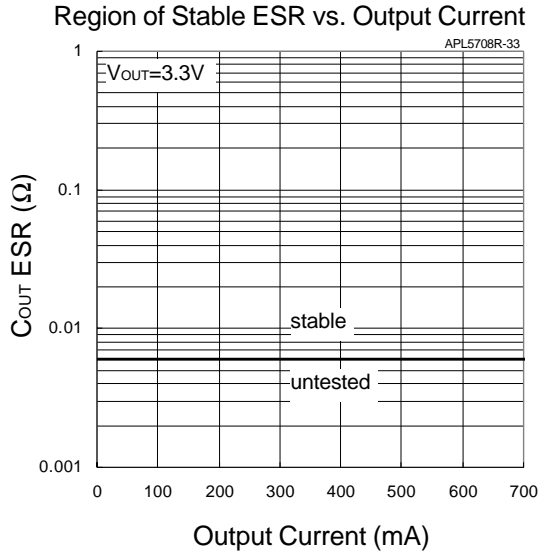

Package Information

SOT-223(Reference JEDEC Registration SOT-223)

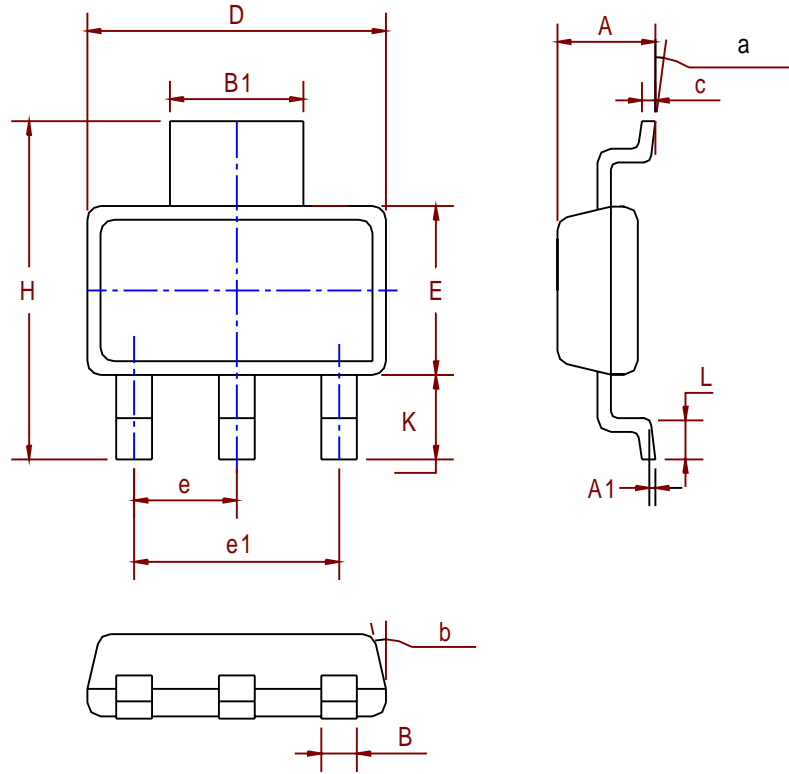

Dim	Millimeters		Inches	
	Min.	Max.	Min.	Max.
A	1.50	1.80	0.06	0.07
A1	0.02	0.08		
B	0.60	0.80	0.02	0.03
B1	2.90	3.10	0.11	0.12
c	0.28	0.32	0.01	0.01
D	6.30	6.70	0.25	0.26
E	3.30	3.70	0.13	0.15
e	2.3 BSC		0.09 BSC	
e1	4.6 BSC		0.18 BSC	
H	6.70	7.30	0.26	0.29
L	0.91	1.10	0.04	0.04
K	1.50	2.00	0.06	0.08
α	0°	10°	0°	10°
β	13°		13°	

Physical Specifications

Terminal Material	Solder-Plated Copper (Solder Material : 90/10 or 63/37 SnPb), 100%Sn
Lead Solderability	Meets EIA Specification RSI86-91, ANSI/J-STD-002 Category 3.

Reflow Condition (IR/Convection or VPR Reflow)

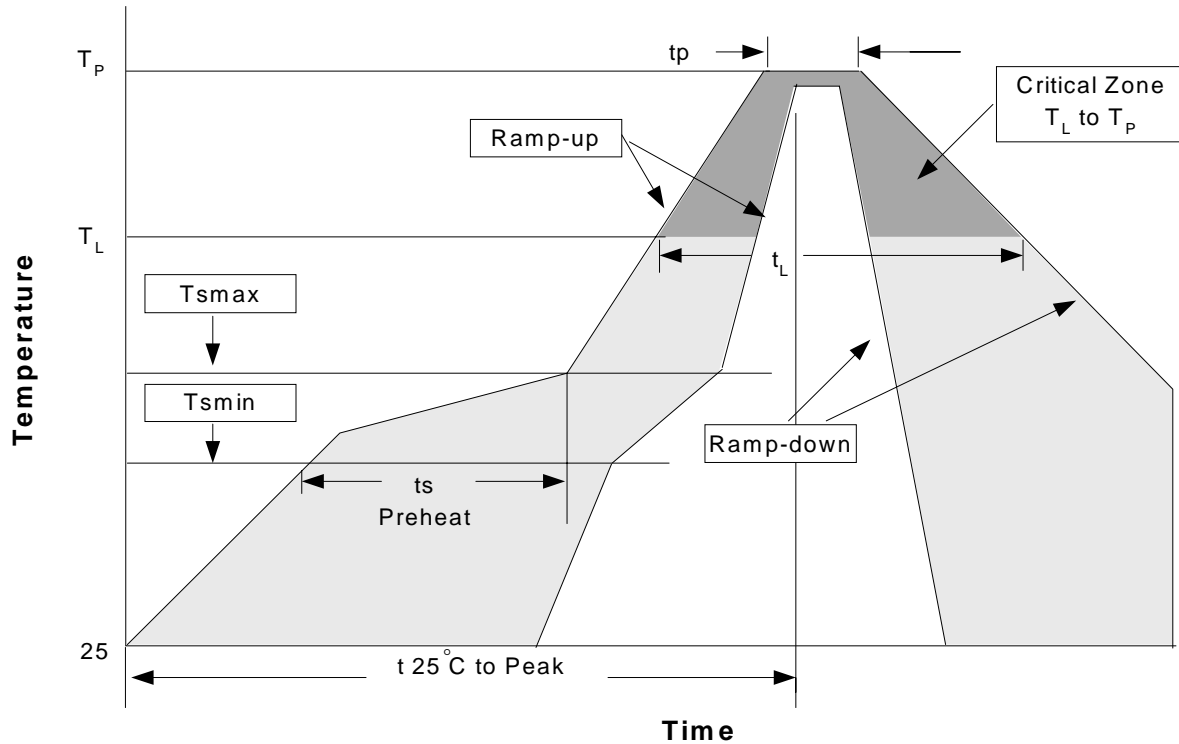

Classification Reflow Profiles

Profile Feature	Sn-Pb Eutectic Assembly	Pb-Free Assembly
Average ramp-up rate (T _L to T _P)	3°C/second max.	3°C/second max.
Preheat		
- Temperature Min (T _{smin})	100°C	150°C
- Temperature Max (T _{smax})	150°C	200°C
- Time (min to max) (t _s)	60-120 seconds	60-180 seconds
Time maintained above:		
- Temperature (T _L)	183°C	217°C
- Time (t _L)	60-150 seconds	60-150 seconds
Peak/Classification Temperature (T _p)	See table 1	See table 2
Time within 5°C of actual Peak Temperature (t _p)	10-30 seconds	20-40 seconds
Ramp-down Rate	6°C/second max.	6°C/second max.
Time 25°C to Peak Temperature	6 minutes max.	8 minutes max.

Notes: All temperatures refer to topside of the package .Measured on the body surface.

Classification Reflow Profiles(Cont.)

Table 1. SnPb Eutectic Process – Package Peak Reflow Temperatures

Package Thickness	Volume mm ³ <350	Volume mm ³ ≥350
<2.5 mm	240 +0/-5°C	225 +0/-5°C
≥2.5 mm	225 +0/-5°C	225 +0/-5°C

Table 2. Pb-free Process – Package Classification Reflow Temperatures

Package Thickness	Volume mm ³ <350	Volume mm ³ 350-2000	Volume mm ³ >2000
<1.6 mm	260 +0°C*	260 +0°C*	260 +0°C*
1.6 mm – 2.5 mm	260 +0°C*	250 +0°C*	245 +0°C*
≥2.5 mm	250 +0°C*	245 +0°C*	245 +0°C*

*Tolerance: The device manufacturer/supplier **shall** assure process compatibility up to and including the stated classification temperature (this means Peak reflow temperature +0°C. For example 260°C+0°C) at the rated MSL level.

Reliability Test Program

Test item	Method	Description
SOLDERABILITY	MIL-STD-883D-2003	245°C,5 SEC
HOLT	MIL-STD 883D-1005.7	1000 Hrs Bias @ 125°C
PCT	JESD-22-B, A102	168 Hrs, 100% RH, 121°C
TST	MIL-STD 883D-1011.9	-65°C ~ 150°C, 200 Cycles

Carrier Tape & Reel Dimensions

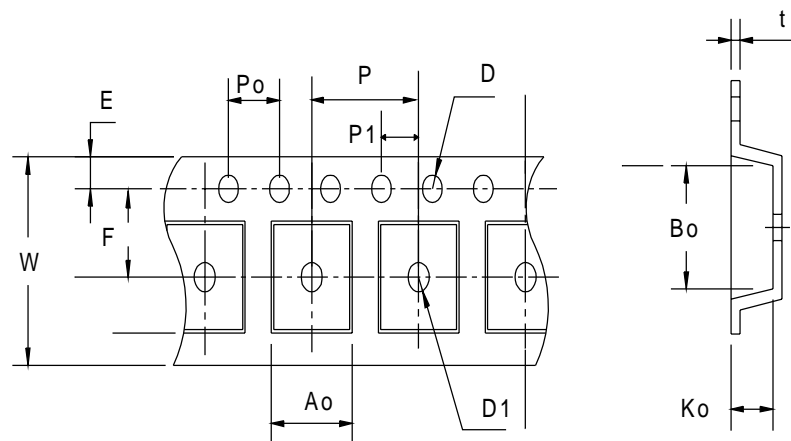

Carrier Tape & Reel Dimensions (Cont.)

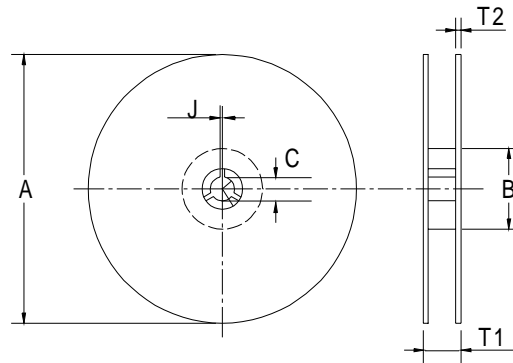

Application	A	B	C	J	T1	T2	W	P	E
SOT-223	330±1	62±1.5	12.75±0.15	2 ± 0.6	12.4 +0.2	2± 0.2	12 ± 0.3	8 ± 0.1	1.75± 0.1
	F	D	D1	Po	P1	Ao	Bo	Ko	t
	5.5 ± 0.05	1.5+ 0.1	1.5+ 0.1	4.0 ± 0.1	2.0 ± 0.05	6.9 ± 0.1	7.5± 0.1	2.1± 0.1	0.3±0.05

(mm)

Cover Tape Dimensions

Application	Carrier Width	Cover Tape Width	Devices Per Reel
SOT- 223	12	9.3	2500

Customer Service

Anpec Electronics Corp.

Head Office :

5F, No. 2 Li-Hsin Road, SBIP,

Hsin-Chu, Taiwan, R.O.C.

Tel : 886-3-5642000

Fax : 886-3-5642050

Taipei Branch :

7F, No. 137, Lane 235, Pac Chiao Rd.,

Hsin Tien City, Taipei Hsien, Taiwan, R. O. C.

Tel : 886-2-89191368

Fax : 886-2-89191369