2 K × 8 CMOS Dual Port RAM

Description

The M67132/67142 are very low power CMOS dual port static RAMs organized as 2048 × 8. They are designed to be used as a stand-alone 8 bit dual port RAM or as a combination MASTER/SLAVE dual port for 16 bits or more width systems. The TEMIC MASTER/SLAVE dual port approach in memory system applications results in full speed, error free operation without the need for additional discrete logic.

Master and slave devices provide two independent ports with separate control, address and I/O pins that permit independent, asynchronous access for reads and writes to any location in the memory. An automatic power down feature controlled by \overline{CS} permits the onchip circuitry of each port in order to enter a very low stand by power mode.

Using an array of eight transistors (8T) memory cell and fabricated with the state of the art 1.0 μm lithography named SCMOS, the M67132/142 combine an extremely low standby supply current (typ = 1.0 μA) with a fast access time at 35 ns over the full temperature range. All versions offer battery backup data retention capability with a typical power consumption at less than 5 μW .

For military/space applications that demand superior levels of performance and reliability the M 67132/142 is processed according to the methods of the latest revision of the MIL STD 883 (class B or S) and/or ESA SCC 9000.

Features

- Fast Access Time
35 ns to 55 ns
30 ns Preliminary for Commercial only
- 67132L/67142L Low Power
67132V/67142V Very Low Power
- Expandable Data Bus to 16 Bits or More Using Master/Slave Devices when Using More than One Device.
- On Chip Arbitration Logic
- \overline{BUSY} Output Flag on Master
- \overline{BUSY} Input Flag on Slave
- Fully Asynchronous Operation from Either Port
- Battery Backup Operation : 2 V Data Retention
- TTL Compatible
- Single 5V \pm 10 % Power Supply

3.3V versions are also available. Please consult sales.
Versions with interrupt are also available. Please consult sales.

M67132/M67142

Interface

Pin Configuration

48 PIN DIL (top view), plastic, ceramic 600 mils

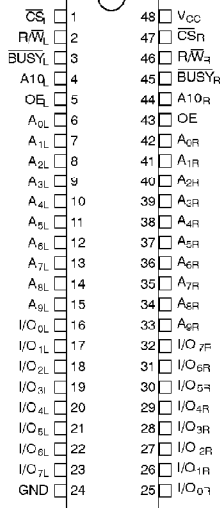

52 PIN PLCC (top view)

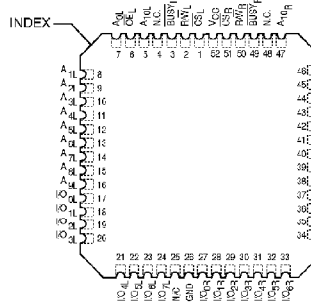

48 PIN PLCC (top view)

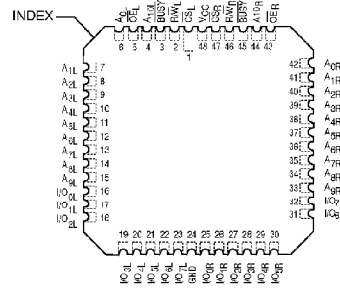

64 PIN VQFP (top view)

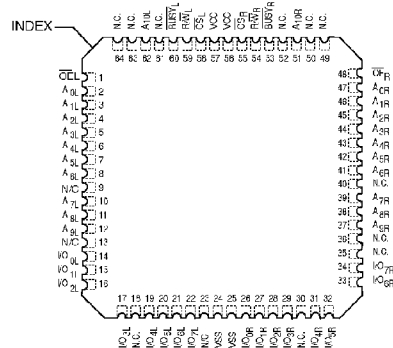

Block Diagram

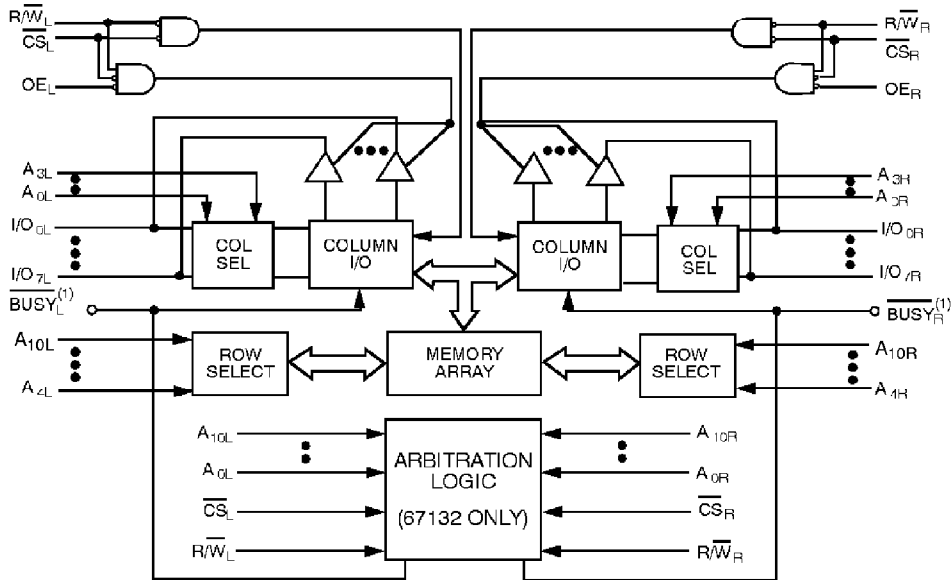

Pin Names

LEFT PORT	RIGHT PORT	NAMES
\overline{CS}_L	\overline{CS}_R	Chip select
R/\overline{W}_L	R/\overline{W}_R	Write Enable
\overline{OE}_L	\overline{OE}_R	Output Enable
$A_{0L} - 10L$	$A_{0R} - 10R$	Address
$I/O_{0L} - 7L$	$I/O_{0R} - 7R$	Data Input/Output
\overline{BUSY}_L	\overline{BUSY}_R	Busy Flag
VCC		Power
GND		Ground

Functional Description

The M 67132/M67142 has two ports with separate control, address and I/O pins that permit independent read/write access to any memory location. These devices have an automatic power-down feature controlled by \overline{CS} . \overline{CS} controls on-chip power-down circuitry which causes the port concerned to go into stand-by mode when not selected (\overline{CS} high). When a port is selected access to the full memory array is permitted. Each port has its own Output Enable control (\overline{OE}). In read mode, the port's \overline{OE} turns the Output drivers on when set LOW. Non-conflicting READ/WRITE conditions are illustrated in table 1.

Arbitration Logic

The arbitration logic will resolve an address match or a chip select match down to a minimum of 5 ns and determine which port has access. In all cases, an active \overline{BUSY} flag will be set for the inhibited port.

The \overline{BUSY} flags are required when both ports attempt to access the same location simultaneously. Should this conflict arise, on-chip arbitration logic will determine which port has access and set the \overline{BUSY} flag for the inhibited port. \overline{BUSY} is set at speeds that allow the processor to hold the operation with its associated address and data. It should be noted that the operation is invalid for the port for which \overline{BUSY} is set LOW. The inhibited port will be given access when \overline{BUSY} goes inactive.

A conflict will occur when both left and right ports are active and the two addresses coincide. The on-chip arbitration determines access in these circumstances. Two modes of arbitration are provided : (1) if the addresses match and are valid before \overline{CS} on-chip control logic arbitrates between \overline{CS}_L and \overline{CS}_R for access ; or (2) if the \overline{CS} s are low before an address match, on-chip

control logic arbitrates between the left and right addresses for access (refer to table 2). The inhibited port's \overline{BUSY} flag is set and will reset when the port granted access completes its operation in both arbitration modes.

Data Bus Width Expansion

Master/Slave Description

Expanding the data bus width to 16 or more bits in a dual-port RAM system means that several chips may be active simultaneously. If every chip has a hardware arbitrator, and the addresses for each chip arrive at the same time one chip may activate its L \overline{BUSY} signal while another activates its R \overline{BUSY} signal. Both sides are now busy and the CPUs will wait indefinitely for their port to become free.

To overcome this "Busy Lock-Out" problem, MHS has developed a MASTER/SLAVE system which uses a single hardware arbitrator located on the MASTER. The SLAVE has \overline{BUSY} inputs which allow direct interface to the MASTER with no external components, giving a speed advantage over other systems.

When dual-port RAMs are expanded in width, the SLAVE RAMs must be prevented from writing until the \overline{BUSY} input has been settled. Otherwise, the SLAVE chip may begin a write cycle during a conflict situation. On the opposite, the write pulse must extend a hold time beyond \overline{BUSY} to ensure that a write cycle occurs once the conflict is resolved. This timing is inherent in all dual-port memory systems where more than one chip is active at the same time.

The write pulse to the SLAVE must be inhibited by the MASTER's maximum arbitration time. If a conflict then occurs, the write to the SLAVE will be inhibited because of the MASTER's \overline{BUSY} signal.

Truth Table

Table 1 : Non Contention Read/Write Control⁽⁴⁾

LEFT OR RIGHT PORT ⁽¹⁾				FUNCTION
R/W	CS	OE	D0-7	
X	H	X	Z	Port Disabled and in Power Down Mode. ICCSB or ICCSB1
L	L	X	DATA _{IN}	Data on Port Written into memory ⁽²⁾
H	L	L	DATA _{OUT}	Data in Memory Output on Port ⁽³⁾
H	L	H	Z	High Impedance Outputs

- Notes :**
1. $\Lambda_{0L} - \Lambda_{10L} \neq \Lambda_{0R} - \Lambda_{10R}$.
 2. If $\overline{\text{BUSY}} = \text{L}$, data is not written.
 3. If $\overline{\text{BUSY}} = \text{L}$, data may not be valid, see t_{WDD} and t_{DD} timing.
 4. H = HIGH, L = LOW, X = DON'T CARE, Z = HIGH IMPEDANCE.

Table 2 : Arbitration⁽⁵⁾

LEFT PORT		RIGHT PORT		FLAGS		FUNCTION
CS _L	A _{0L} - A _{10L}	CS _R	A _{0R} - A _{10R}	BUSY _L	BUSY _R	FUNCTION
H	X	H	X	H	H	No Contention
L	Any	H	X	H	H	No Contention
H	X	L	Any	H	H	No Contention
L	$\neq A_{0R} - A_{10R}$	L	$\neq A_{0L} - A_{10L}$	H	H	No Contention
ADDRESS ARBITRATION WITH $\overline{\text{CE}}$ LOW BEFORE ADDRESS MATCH						
L	LV5R	L	LV5R	H	L	L-Port Wins
L	RV5L	L	RV5L	L	H	R-Port Wins
L	Same	L	Same	H	L	Arbitration Resolved
L	Same	L	Same	L	H	Arbitration Resolved
$\overline{\text{CS}}$ ARBITRATION WITH ADDRESS MATCH BEFORE $\overline{\text{CS}}$						
LL5R	$= A_{0R} - A_{10R}$	LL5R	$= A_{0L} - A_{10L}$	H	L	L-Port Wins
RL5L	$= A_{0R} - A_{10R}$	RL5L	$= A_{0L} - A_{10L}$	L	H	R-Port Wins
LW5R	$= A_{0R} - A_{10R}$	LW5R	$= A_{0L} - A_{10L}$	H	L	Arbitration Resolved
LW5R	$= A_{0R} - A_{10R}$	LW5R	$= A_{0L} - A_{10L}$	L	H	Arbitration Resolved

- Notes :**
5. X - DON'T CARE, L - LOW, H - HIGH.
 LV5R = Left Address Valid ≥ 5 ns before right address.
 RV5L = Right address Valid ≥ 5 ns before left address.
 Same = Left and Right Addresses match within 5 ns of each other.
 LL5R = Left $\overline{\text{CS}} = \text{LOW} \geq 5$ ns before Right $\overline{\text{CS}}$.
 RL5L = Right $\overline{\text{CS}} = \text{LOW} \geq 5$ ns before left $\overline{\text{CS}}$.
 LW5R = Left and Right $\overline{\text{CS}} = \text{LOW}$ within 5 ns of each other.

Electrical Characteristics

Absolute Maximum Ratings

Supply voltage (VCC–GND) : –0.3 V to 7.0 V
 Input or output voltage applied : . . . (GND –0.3 V) to (VCC + 0.3 V)
 Storage temperature : –65°C to + 150°C

** Notice*

Stresses greater than those listed under ABSOLUTE MAXIMUM RATINGS may cause permanent damage to the device. This is a stress rating only and functional operation of the device at these or any other conditions above those indicated in the operational sections of this specification is not implied. Exposure to absolute maximum rating conditions for extended periods may affect reliability.

OPERATING RANGE	OPERATING SUPPLY VOLTAGE	OPERATING TEMPERATURE
Military	V _{CC} = 5 V ± 10 %	– 55 °C to + 125 °C
Automotive	V _{CC} = 5 V ± 10 %	– 40 °C to + 125 °C
Commercial	V _{CC} = 5 V ± 10 %	0 °C to + 70 °C
Industrial	V _{CC} = 5 V ± 10 %	– 40 °C to + 85 °C

DC Parameters

Parameter	Description	Version	67132/142–30		67132/142–35		67132/142–45		67132/142–55		Unit	Value
			Preliminary COM	COM	IND MIL AUTO	COM	IND MIL AUTO	COM	IND MIL AUTO			
I _{CCSB} (6)	Standby supply current (Both ports TTL level inputs)	V L	5 40	5 40	5 50	5 40	5 50	5 40	5 50	mA mA	Max Max	
I _{CCSB1} (7)	Standby supply current (Both ports CMOS level inputs)	V L	100 1000	100 1000	200 2000	100 1000	200 2000	100 1000	200 2000	µA µA	Max Max	
I _{CCOP} (8)	Operating supply current (Both ports active)	V L	160 175	145 155	180 200	135 150	150 170	130 140	140 170	mA mA	Max Max	
I _{CCOP1} (9)	Operating supply current (One port active – One port standby)	V L	100 105	85 95	100 110	75 85	85 90	70 80	75 80	mA mA	Max Max	

- Notes : 6. $\overline{CS}_L = \overline{CS}_R \geq 2.2$ V.
 7. $\overline{CS}_L = \overline{CS}_R \geq V_{XX} - 0.2$ V.
 8. Both ports active – Maximum frequency – Outputs open – $\overline{OE} = V_{IH}$.
 9. One port active (f = MAX) – Output open – One port stand-by TTL or CMOS Level inputs – $\overline{CS}_L = \overline{CS}_R \geq 2.2$ V.

PARAMETER	DESCRIPTION	67132–30/35/45/55 67142–30/35/45/55	UNIT	VALUE
I/O ₍₁₀₎	Input/Output leakage current	+/- 10	µA	Max
VIL ₍₁₁₎	Input low voltage	0.8	V	Max
VIH ₍₁₁₎	Input high voltage	2.2	V	Min
VOL ₍₁₂₎	Output low voltage	0.4	V	Max
VOL ₍₁₃₎	Open drain output low voltage (BUSY)	0.5	V	Max
VOH ₍₁₂₎	Output high voltage	2.4	V	Min
CIN ₍₁₇₎	Input capacitance	5	pF	Max
COU _T (17)	Output capacitance	7	pF	Max

- Notes : 10. V_{CC} = 5 V, Vin = Gnd to V_{CC}, $\overline{CS} = V_{IH}$, Vout = 0 to V_{CC}.
 11. V_{IH} max = V_{CC} + 0.3 V, V_{IL} min – 0.3 V or –1 V pulse width 50 ns.
 12. V_{CC} min, IOL = 4 mA, IOH = 4 mA.
 13. IOL = 16 mA.

Data-Retention Mode

MHS CMOS RAMs are designed with battery backup in mind. Data retention voltage and supply current are guaranteed over temperature. The following rules insure data retention :

1 – Chip select (\overline{CS}) must be held high during data retention ; within V_{CC} to $V_{CC_{DR}}$.

2 – \overline{CS} must be kept between $V_{CC} - 0.2 V$ and 70 % of V_{CC} during the power up and power down transitions.

3 – The RAM can begin operation $> t_{RC}$ after V_{CC} reaches the minimum operating voltage (4.5 volts).

Timing

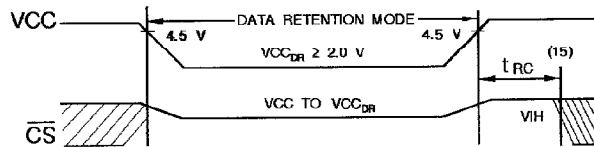

PARAMETER	TEST CONDITIONS (14)	MAX		UNIT
		COM	MIL IND AUTO	
ICC _{DR1}	@ V _{CC_{DR}} = 2 V	5	20	μA
ICC _{DR2}	@ V _{CC_{DR}} = 3 V	10	30	μA

Notes : 14. $\overline{CS} = V_{CC}$, $V_{in} = Gnd$ to V_{CC} .
15. t_{RC} = Read cycle time.

AC Test Conditions

Input Pulse Levels : GND to 3.0 V
Input Rise/Fall Times : 5 ns
Input Timing Reference Levels : 1.5 V

Output Reference Levels : 1.5 V
Output Load : see figures 1, 2

Figure 1. Output Load.

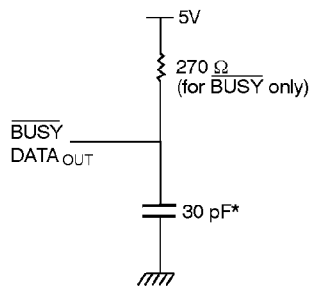

* Including scope and jig

Figure 2. Output load.
(For t_{HZ} , t_{LZ} , t_{WZ} , and t_{OW})

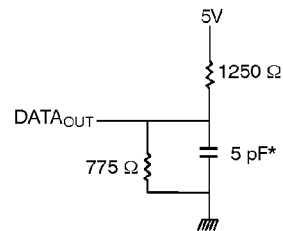

AC Parameters

READ CYCLE		PARAMETER	M67132-30(*)	M67132-35(**)	M67132-45	M67132-55	UNIT				
SYMBOL (19)	SYMBOL (20)		MIN.	MAX.	MIN.	MAX.		MIN.	MAX.		
			PRELIMINARY								
TAVAVR	t _{RC}	Read cycle time	30	-	35	-	45	-	55	ns	
TAVQV	t _{AA}	Address access time	-	30	-	35	-	45	-	55	ns
TELQV	t _{ACS}	Chip Select access time (18)	-	30	-	35	-	45	-	55	ns
TGLQV	t _{AOE}	Output enable access time	-	15	-	25	-	30	-	35	ns
TAVQX	t _{OH}	Output hold from address change	0	-	0	-	0	-	0	-	ns
TELQZ	t _{LZ}	Output low Z time (16, 17)	0	-	5	-	5	-	5	-	ns
TEHQZ	t _{HZ}	Output high Z time (16, 17)	-	12	-	15	-	20	-	30	ns
TPU	t _{PU}	Chip Select to power up time (17)	0	-	0	-	0	-	0	-	ns
TPD	t _{PD}	Chip disable to power down time (17)	-	50	-	50	-	50	-	50	ns

- Notes :
16. Transition is measured ± 500 mV from low or high impedance voltage with load (figures 1 and 2).
 17. This parameter is guaranteed but not tested.
 18. To access RAM $\overline{CS} = V_{IL}$.
 19. STD symbol.
 20. ALT symbol.
 - (*) Commercial only, not available in DIP.
 - (**) DIP package available for commercial only.

Timing Waveform of Read Cycle n° 1, Either Side (21, 22, 24)

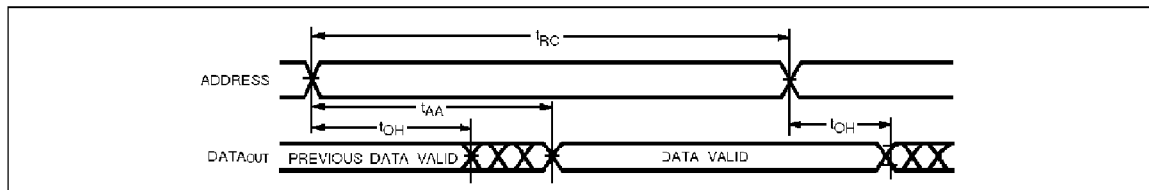

Timing Waveform of Read Cycle n° 2, Either Side (21, 23, 25)

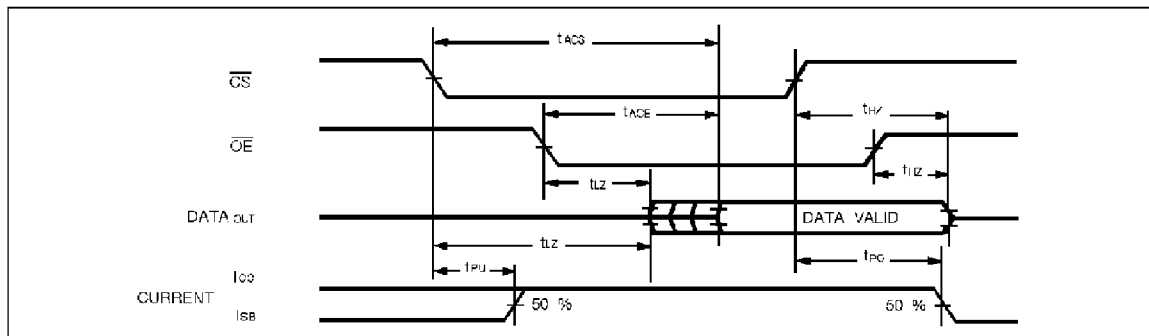

- Notes :
21. R/ \overline{W} is high for read cycles.
 22. Device is continuously enabled, $\overline{CS} = V_{IL}$.
 23. Addresses valid prior to or coincident with \overline{CS} transition low.
 24. $\overline{OE} = V_{IL}$.
 25. To access RAM, $\overline{CS} = V_{IL}$.

AC Parameters

WRITE CYCLE		PARAMETER	M67132-30(*) M67142-30(*)		M67132-35(**) M67142-35(**)		M67132-45 M67142-45		M67132-55 M67142-55		UNIT
SYMBOL (30)	SYMBOL (31)		MIN.	MAX.	MIN.	MAX.	MIN.	MAX.	MIN.	MAX.	
			PRELIMINARY								
TAVAVW	t _{WC}	Write cycle time	30	–	35	–	45	–	55		ns
TELWH	t _{SW}	Chip select to end of write (28)	25	–	30		35	–	40	–	ns
TAVWH	t _{AW}	Address valid to end of write	25	–	30		35	–	40	–	ns
TAVWL	t _{AS}	Address Set up Time	0		0		0		0		ns
TWLWH	t _{WP}	Write Pulse Width	25	–	30	–	35	–	40	–	ns
TWHAX	t _{WR}	Write Recovery Time	0	–	0	–	0	–	0	–	ns
TDVWH	t _{DW}	Data Valid to end of write	15	–	20	–	20	–	20	–	ns
TGIIQZ	t _{HZ}	Output high Z time (26, 27)	–	12	–	15	–	20	–	30	ns
TWHDX	t _{DH}	Data hold time (29)	0	–	0	–	0	–	0	–	ns
TWLQZ	t _{WZ}	Write enable to output in high Z (26, 27)	–	12	–	15	–	20	–	30	ns
TWHQX	t _{OW}	Output active from end of write (26, 27, 29)	0	–	0	–	0	–	0	–	ns

- Notes :**
- 26. Transition is measured ± 500 mV from low or high impedance voltage with load (figures 1 and 2).
 - 27. This parameter is guaranteed but not tested.
 - 28. To access RAM $\overline{CS} = \text{VIL}$.
This condition must be valid for entire t_{SW} time.
 - 29. The specification for t_{DH} must be met by the device supplying write data to the RAM under all operating conditions.
Although t_{DH} and t_{OW} values vary over voltage and temperature, the actual t_{DH} will always be smaller than the actual t_{OW}.
 - 30. STD symbol.
 - 31. ALT symbol.
 - (*). Commercial only, not available in DIP.
 - (**). DIP package available for commercial only.

Timing Waveform of Write Cycle n° 1, R/W Controlled Timing (32, 33, 34, 38)

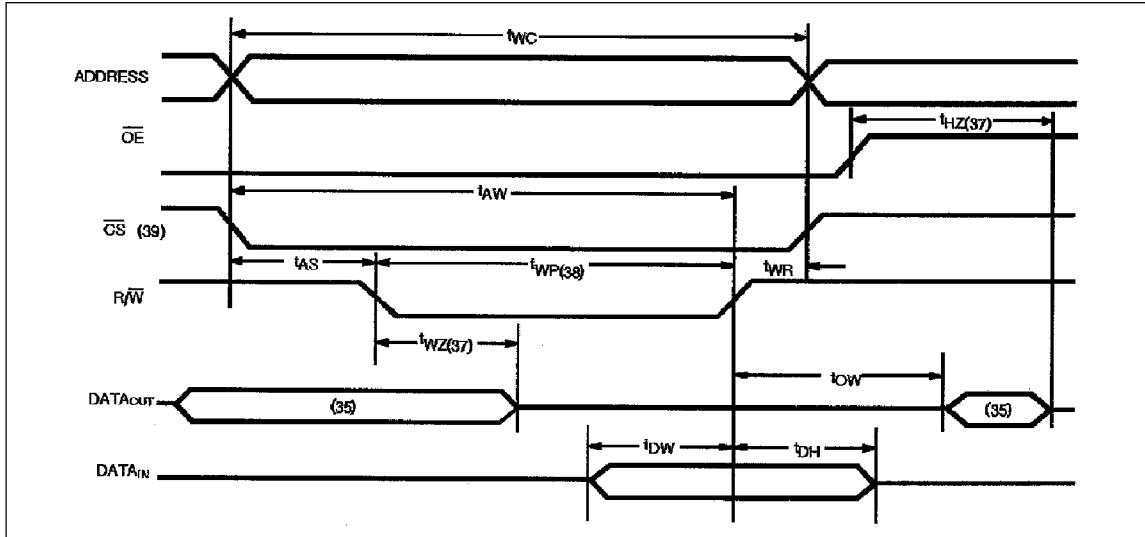

Timing Waveform of Write Cycle n° 2, CS Controlled Timing (32, 33, 34, 36)

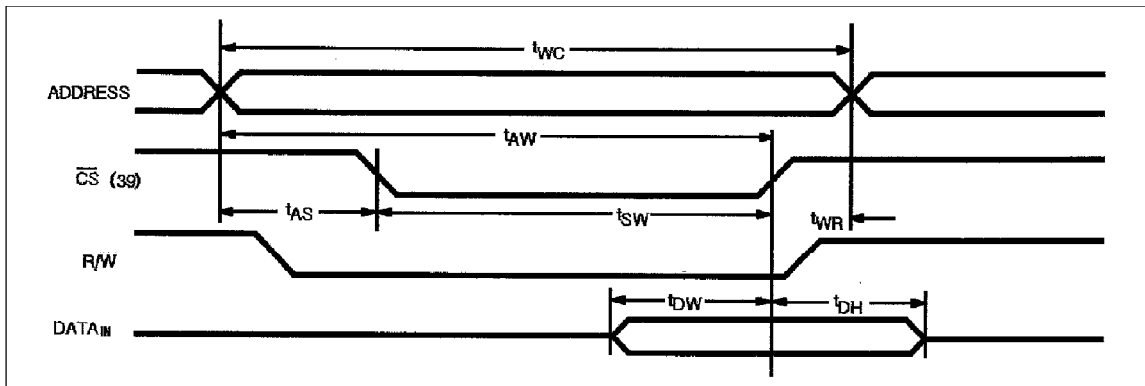

- Notes :
- 32. R/W must be high during all address transitions.
 - 33. A write occurs during the overlap (t_{SW} or t_{WP}) of a low CS and a low R/W.
 - 34. t_{WR} is measured from the earlier of CS or R/W going high to the end of write cycle.
 - 35. During this period, the I/O pins are in the output state, and input signals must not be applied.
 - 36. If the CS low transition occurs simultaneously with or after the R/W low transition, the outputs remain in the high impedance state.
 - 37. Transition is measured ± 500 mV from steady state with a 5 pF load (including scope and jig). This parameter is sampled and not 100 % tested.
 - 38. If OE is low during a R/W controlled write cycle, the write pulse width must be the larger of t_{WP} or $(t_{WZ} + t_{DW})$ to allow the I/O drivers to turn off and data to be placed on the bus for the required t_{DW} . If OE is high during an R/W controlled write cycle, this requirement does not apply and the write pulse can be as short as the specified t_{WP} .
 - 39. To access RAM, CS = VIL.

AC Parameters

SYM-BOL	PARAMETER	M67132-30(*) M67142-30(*)		M67132-35(**) M67142-35(**)		M67132-45 M67142-45		M67132-55 M67142-55		UNIT
		MIN.	MAX.	MIN.	MAX.	MIN.	MAX.	MIN.	MAX.	
BUSY TIMING (For M67132 only)										
		PRELIMINARY								
t _{BAA}	$\overline{\text{BUSY}}$ Access time to address	–	30	–	35	–	35	–	45	ns
t _{BDA}	$\overline{\text{BUSY}}$ Disable time to address	–	25	–	30	–	35	–	40	ns
t _{BAC}	$\overline{\text{BUSY}}$ Access time to Chip Select	–	25	–	30	–	30	–	35	ns
t _{BDC}	$\overline{\text{BUSY}}$ Disable time to Chip Select		25		25		25		30	ns
t _{WDD}	Write Pulse to data delay (40)	–	55	–	60	–	70	–	80	ns
t _{DDD}	Write data valid to read data delay (40)	–	33	–	35	–	45	–	55	ns
t _{APS}	Arbitration priority set-up time (41)	5	–	5	–	5	–	5	–	ns
t _{BDD}	$\overline{\text{BUSY}}$ disable to valid data	–	Note 42	–	Note 42	–	Note 42	–	Note 42	ns
BUSY TIMING (For M67142 only)										
t _{WB}	Write to $\overline{\text{BUSY}}$ input (43)	0		0		0		0		ns
t _{WH}	Write hold after $\overline{\text{BUSY}}$ (44)	20	–	20	–	20	–	20	–	ns
t _{WDD}	Write pulse to data delay (45)	–	55	–	60	–	70	–	80	ns
t _{DDD}	Write data valid to read data delay (45)	–	30	–	35	–	45	–	55	ns

Notes : 40. Port-to-port delay through RAM cells from writing port to reading port, refer to “Timing Waveform of Read with $\overline{\text{BUSY}}$ (For M67132 only)”.

41. To ensure that the earlier of the two ports wins.

42. t_{BDD} is a calculated parameter and is the greater of 0, t_{WDD} – t_{WP} (actual) or t_{DDD} – t_{DW} (actual).

43. To ensure that the write cycle is inhibited during contention.

44. To ensure that a write cycle is completed after contention.

45. Port-to-port delay through RAM cells from writing port to reading port, refer to “Timing Waveforms of Read with Port to port delay (For M67132 only)”.

(*). Commercial only, not available in DIP.

(**). DIP package for commercial only.

Timing Waveform of Read with $\overline{\text{BUSY}}$ (46, 47, 48) (For M67132)

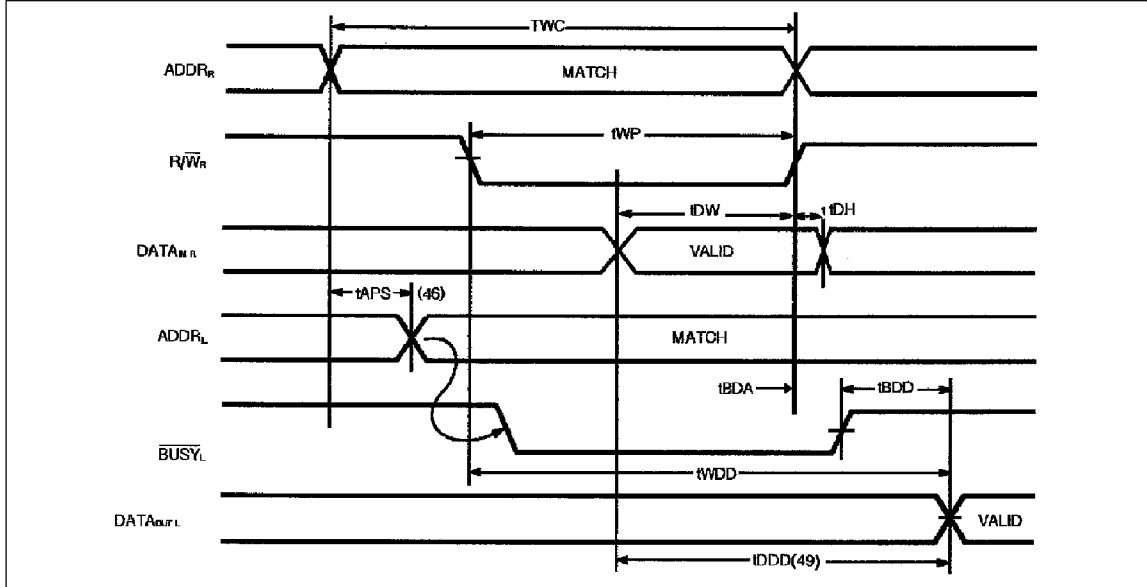

- Notes :**
- 46. To ensure that the earlier of the two port wins.
 - 47. Write cycle parameters should be adhered to, to ensure proper writing.
 - 48. Device is continuously enabled for both ports.
 - 49. $\overline{\text{OE}}$ at L for the reading port.

Timing Waveform of Write with Port-to-port (50, 51, 52) (For M67142 only)

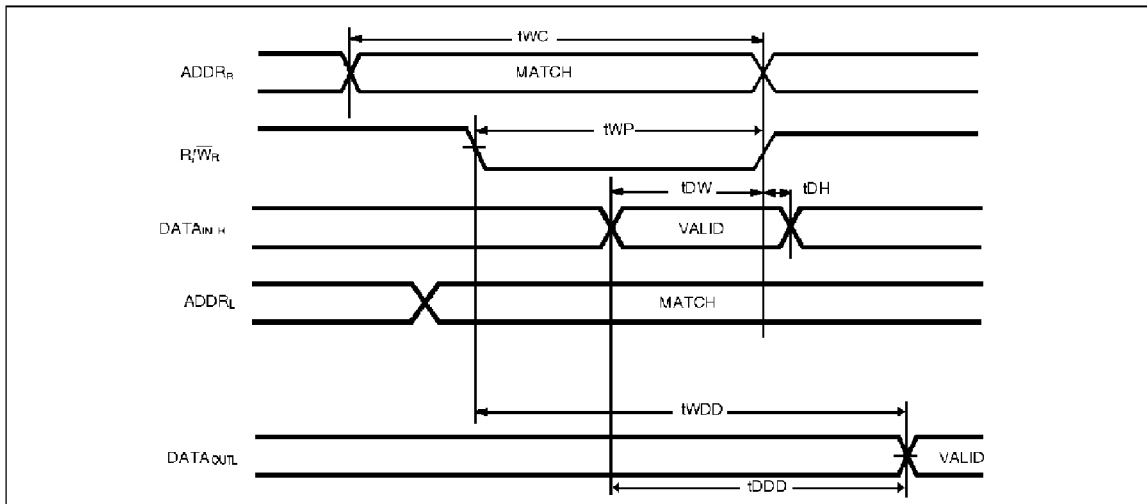

- Notes :**
- 50. Assume $\overline{\text{BUSY}} = \text{H}$ for the writing port, and $\overline{\text{OE}} = \text{L}$ for the reading port.
 - 51. Write cycle parameters should be adhered to, to ensure proper writing.
 - 52. Device is continuously enabled for both ports.

Timing Waveform of Write with $\overline{\text{BUSY}}$ (For M67132)

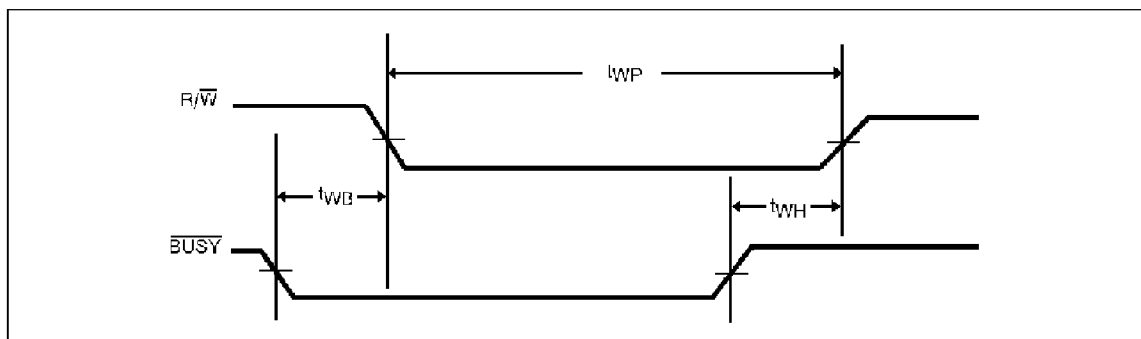

Timing Waveform of Contention Cycle n° 1, $\overline{\text{CS}}$ Arbitration (For M67132 only)

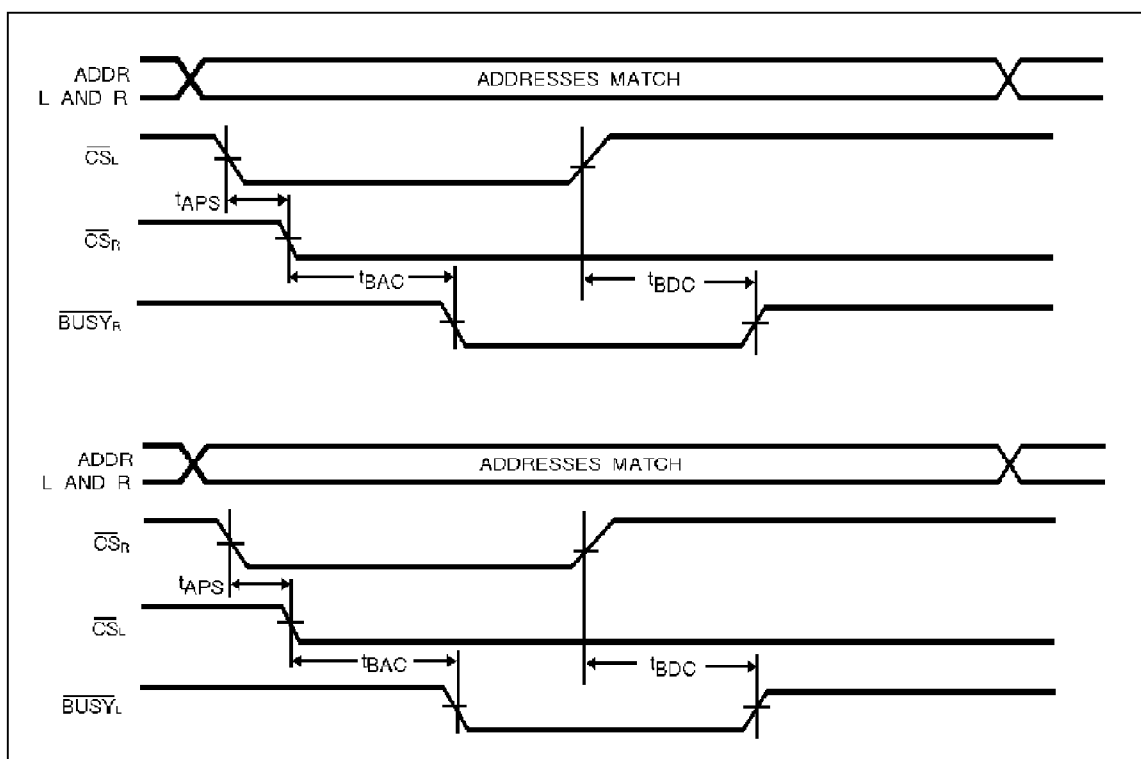

**Timing Waveform of Contention Cycle n° 2, Address Valid Arbitration
(For M67132 only) (53)**

Left Address Valid First :

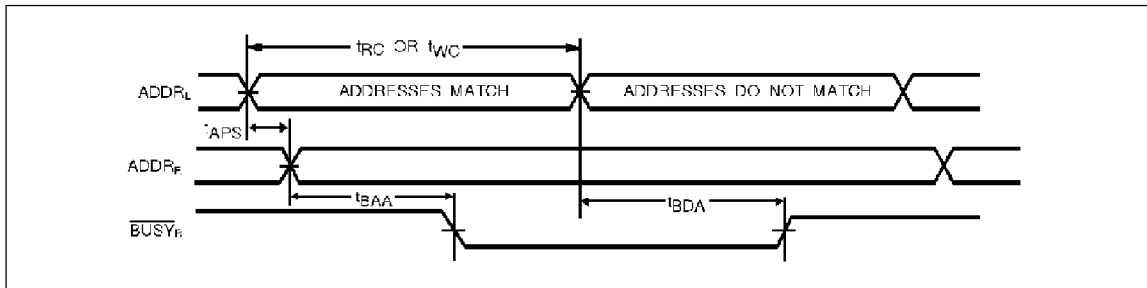

Right Address Valid First :

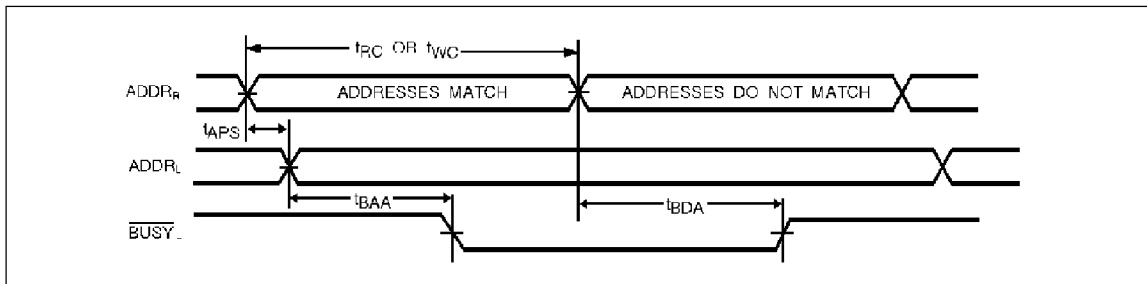

Note : 53. $\overline{CS}_L - \overline{CS}_R - V_{IL}$

16 Bit Master/Slave Dual-port Memory Systems

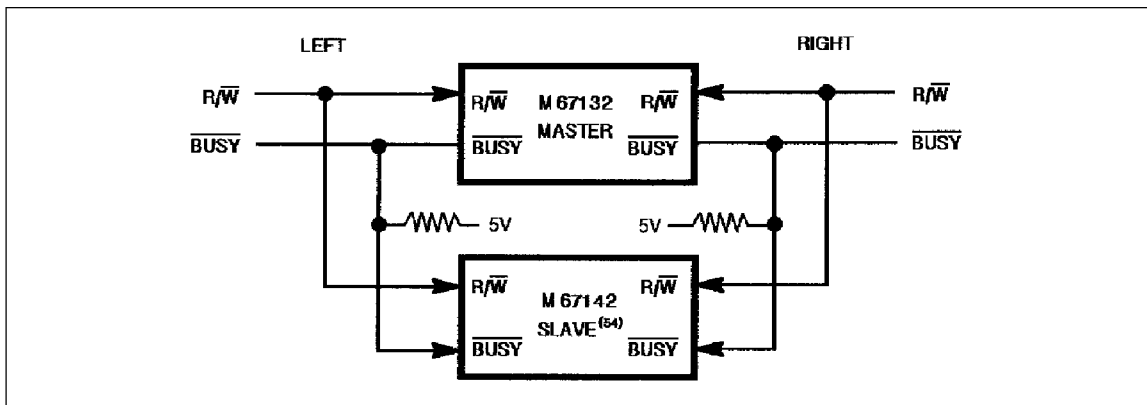

Note : 54. No arbitration in M67142 (SLAVE). \overline{BUSY} IN inhibits write in M67142 (SLAVE).

M67132/M67142

Ordering Information

TEMPERATURE RANGE		PACKAGE	DEVICE	SPEED	FLOW
C	M	S3	67132V	30	
1K = 48 pin DIL ceramic 600 mils CK = 48 pin DIL side-brazed 600 mils 4K = 48 pin LCC S3 = 52 pin PLCC 3K = 48 pin DIL plastic 600 mils RD = 64 pin VQFP KK = Flat pack 48 pins 400 mils Q3 = CQPJ52 0 = Dice form				30 ns 35 ns 45 ns 55 ns	blank = MHS standards /883 = MIL STD 883 Class B or S P883 = MIL STD 883 + PIND test SB/SC = SCC 9000 level B/C SHXXX = Special customer request FHXXX = Flight models (space) EHXXX = Engineering models (space) MHXXX = Mechanical parts (space) LHXXX = Life test parts (space) : R = Tape and reel : RD = Tape and reel dry pack : D = Dry pack
C = Commercial	0° to +70°C		67132 = 16K (2K × 8) Master		
I = Industrial	-40° to +85°C		67142 = 16K (2K × 8) Slave		
A = Automotive	-40° to +125°C		L = Low power		
M = Military	55° to +125°C		V = Very low power		
S = Space	-55° to +125°C				

Military and Space Versions

The following tables give package/consumption/access time/process flow available combinations

Temp. range	Packages	Consumption		Access Time (ns)			Std process 67132 Mil flows (including SMD5962-87002)	RT process 67132E	
		V	L	35	45	55		Mil flows	Space flows (including SCC9301033)
M	1K 4K CK KK Q3 0	● ● ● X ● X	● ● ● X ● ●	● ● ● X ● X	● ● ● X ● X	● ● ● X ● ●	● ● ● X ● ●		
S	4K CK KK 0	● ● X X			● ● X X	● ● X ●		● ● X ●	● ● X ●

Temp. range	Packages	Consumption		Access Time (ns)			Std process 67142 Mil flows (including SMD5962-87002)	RT process 67142E	
		V	L	35	45	55		Mil flows	Space flows (including SCC9301033)
M	1K 4K CK KK Q3 0	● ● ● X ● X	● ● ● X ● ●	● ● ● X ● X	● ● ● X ● X	● ● ● X ● ●	● ● ● X ● ●		
S	4K CK KK 0	● ● X X			● ● X X	● ● X ●		● ● X ●	● ● X ●

● = product in production

X = call sales office for availability

The information contained herein is subject to change without notice. No responsibility is assumed by TEMIC for using this publication and/or circuits described herein : nor for any possible infringements of patents or other rights of third parties which may result from its use.