

Typical Applications

The HMC453ST89 / HMC453ST89E is ideal for applications requiring a high dynamic range amplifier:

- GSM, GPRS & EDGE
- CDMA & W-CDMA
- CATV/Cable Modem
- Fixed Wireless

Features

- Output IP3: +49 dBm
- 20.5 dB Gain @ 400 MHz
- 7.5 dB Gain @ 2100 MHz
- 41% PAE @ +32.5 dBm Pout
- +26 dBm CDMA2000 Channel Power @ -45 dBc ACP
- Included in the HMC-DK002 Designer's Kit

Functional Diagram

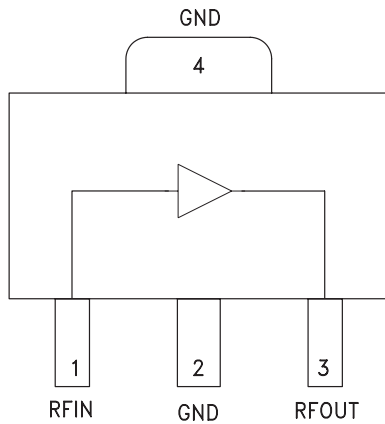

General Description

The HMC453ST89 & HMC453ST89E are high dynamic range GaAs InGaP HBT 1.6 Watt MMIC power amplifiers operating from 0.4 to 2.2 GHz and packaged in industry standard SOT89 packages. Utilizing a minimum number of external components and a single +5V supply, the amplifier output IP3 can be optimized to +47 dBm at 0.4 GHz or +49 dBm at 2.1 GHz. The high output IP3 and PAE make the HMC453ST89 & HMC453ST89E ideal power amplifiers for Cellular/PCS/3G and Fixed Wireless applications.

Electrical Specifications, $T_A = +25^\circ\text{C}$, $V_S = +5\text{V}$ [1]

| Parameter | Min. | Typ. | Max. | Min. | Typ. | Max. | Min. | Typ. | Max. | Min. | Typ. | Max. | Min. | Typ. | Max. | Units |
|---|-----------|-------|------|-----------|-------|------|-----------|-------|------|-------------|-------|------|-------------|-------|------|---------|
| Frequency Range | 400 - 410 | | | 450 - 496 | | | 810 - 960 | | | 1710 - 1990 | | | 2010 - 2170 | | | MHz |
| Gain | 18 | 20.5 | | 16.5 | 19 | | 12 | 14.5 | | 6 | 8.5 | | 6 | 7.5 | | dB |
| Gain Variation Over Temperature | | 0.012 | 0.02 | | 0.012 | 0.02 | | 0.012 | 0.02 | | 0.012 | 0.02 | | 0.012 | 0.02 | dB / °C |
| Input Return Loss | | 20 | | | 14 | | | 20 | | | 15 | | | 13 | | dB |
| Output Return Loss | | 12 | | | 12 | | | 13 | | | 15 | | | 18 | | dB |
| Output Power for 1dB Compression (P1dB) | 28.5 | 31.5 | | 29 | 32 | | 28.5 | 31.5 | | 29 | 32 | | 29.5 | 32.5 | | dBm |
| Saturated Output Power (Psat) | | 32 | | | 32.25 | | | 31.75 | | | 32.5 | | | 32.75 | | dBm |
| Output Third Order Intercept (IP3) [2] | 44 | 47 | | 45 | 48 | | 44 | 47 | | 46 | 49 | | 46 | 49 | | dBm |
| Noise Figure | | 9 | | | 9 | | | 6.5 | | | 7 | | | 6.5 | | dB |
| Supply Current (Icq) | | 725 | | | 725 | | | 725 | | | 725 | | | 725 | | mA |

[1] Specifications and data reflect HMC453ST89 measured using the respective application circuits for each designated frequency band found herein. Contact the HMC Applications Group for assistance in optimizing performance for your application.

[2] Two-tone input power of 0 dBm per tone, 1 MHz spacing.



**Broadband Gain
& Return Loss @ 400**

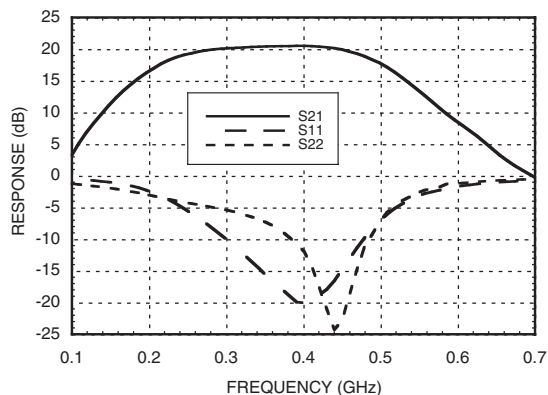

Gain vs. Temperature @ 400 MHz

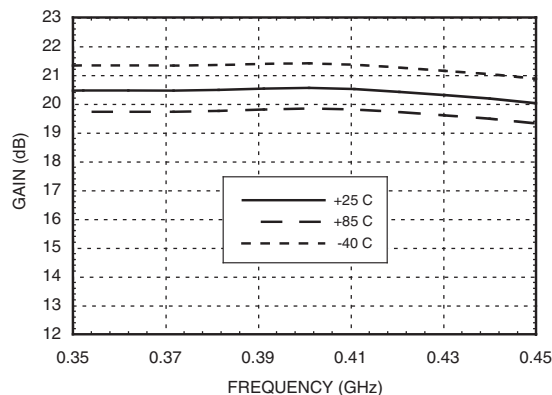

**Input Return Loss
vs. Temperature @ 400 MHz**

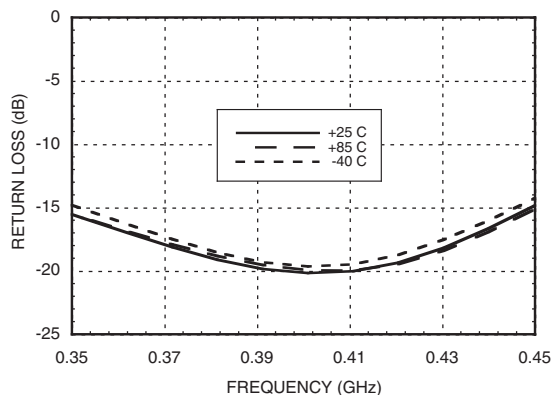

**Output Return Loss
vs. Temperature @ 400 MHz**

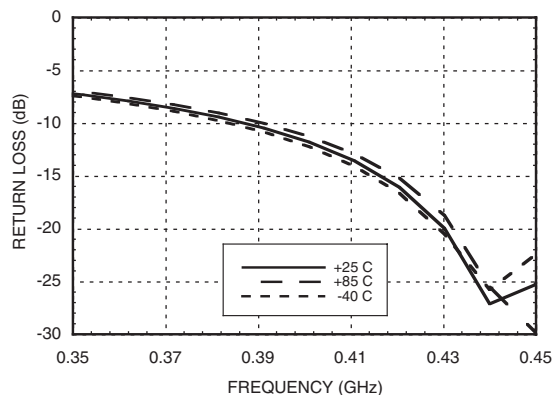

P1dB vs. Temperature @ 400 MHz

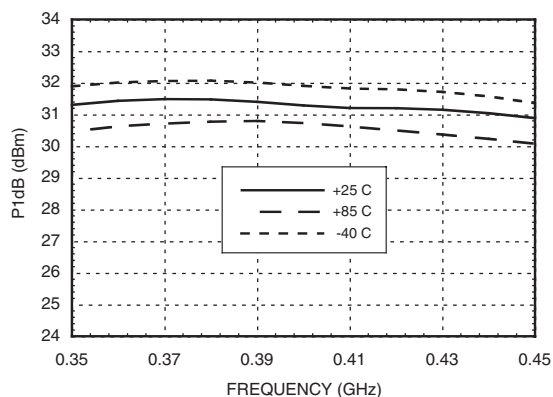

Psat vs. Temperature @ 400 MHz

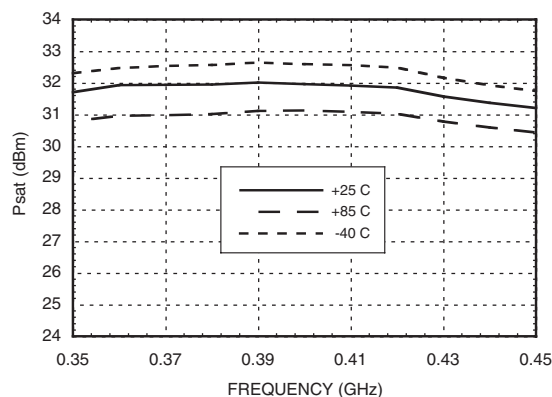

Output IP3 vs. Temperature @ 400 MHz

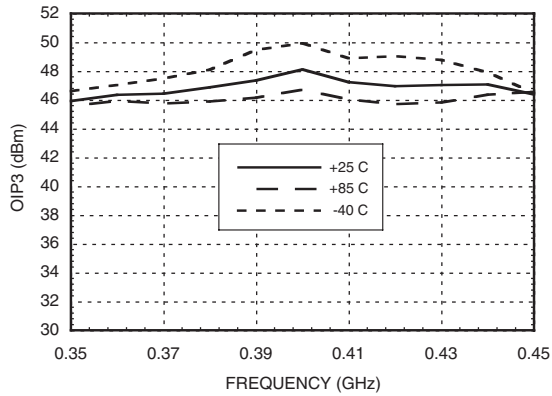

Noise Figure vs. Temperature @ 400 MHz

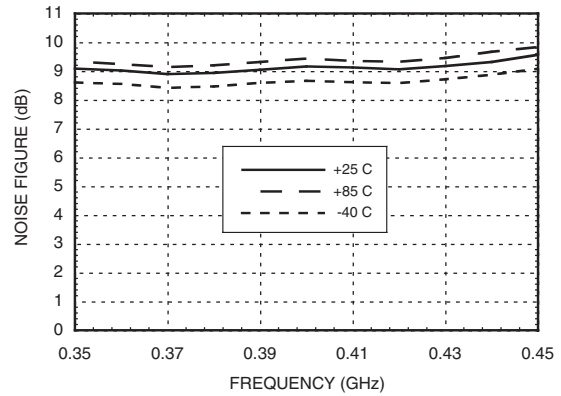

Reverse Isolation vs. Temperature @ 400 MHz

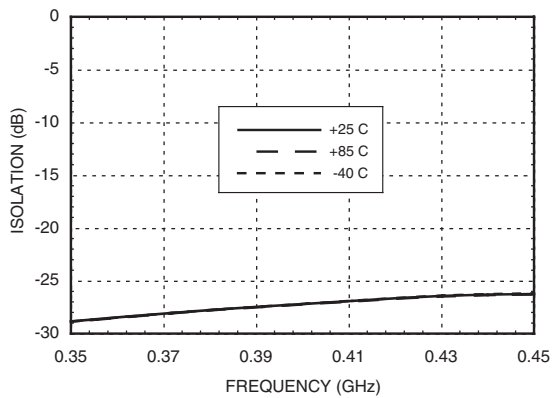

Gain, Power & IP3 vs. Supply Voltage @ 400 MHz

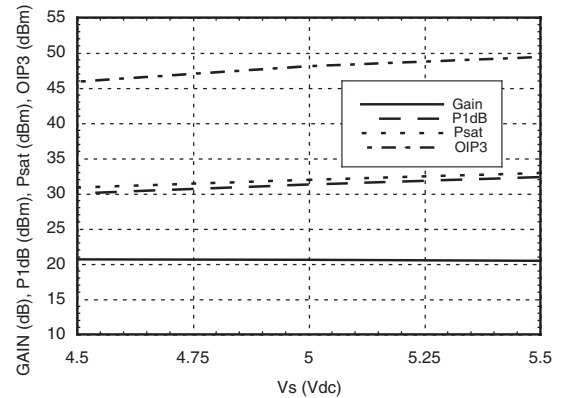

Power Compression @ 400 MHz

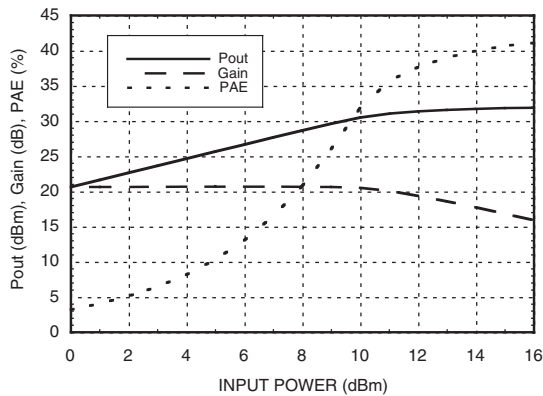

ACPR vs. Supply Voltage @ 400 MHz W-CDMA, 64 DPCH

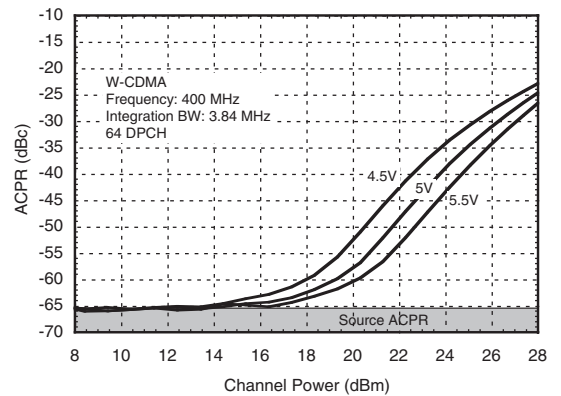



Broadband Gain & Return Loss @ 470 MHz

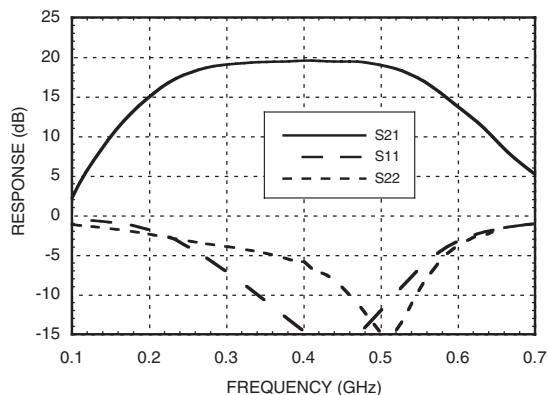

Gain vs. Temperature @ 470 MHz

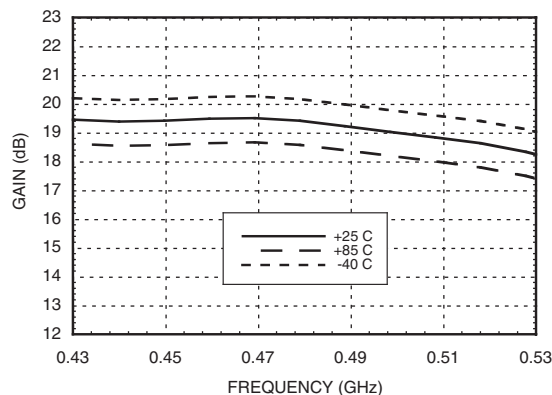

Input Return Loss vs. Temperature @ 470 MHz

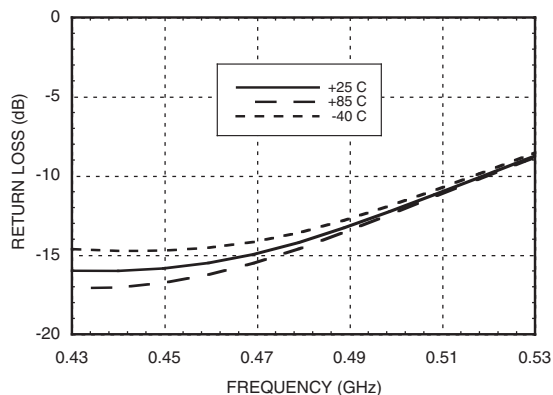

Output Return Loss vs. Temperature @ 470 MHz

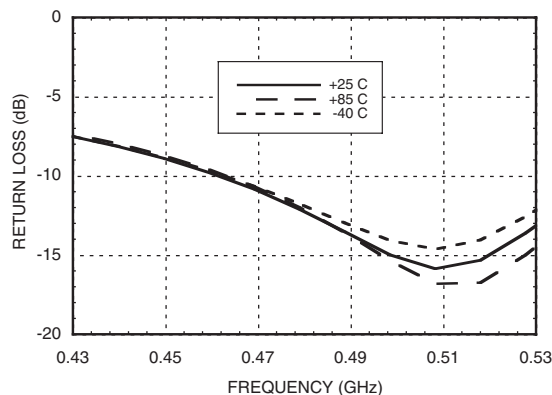

P1dB vs. Temperature @ 470 MHz

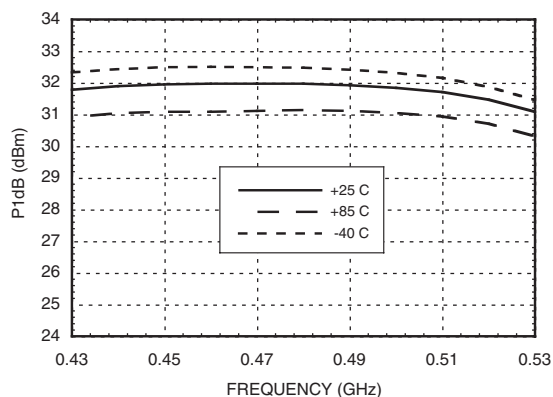

Psat vs. Temperature @ 470 MHz

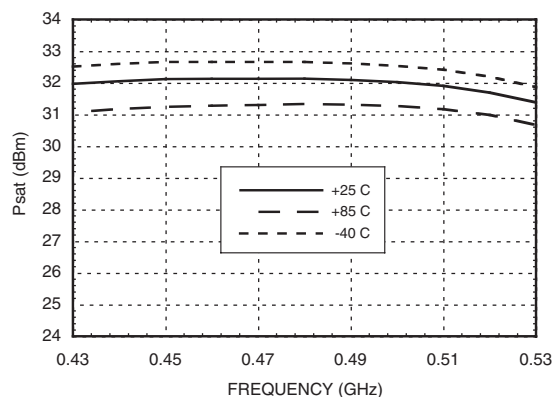

Output IP3 vs. Temperature @ 470 MHz

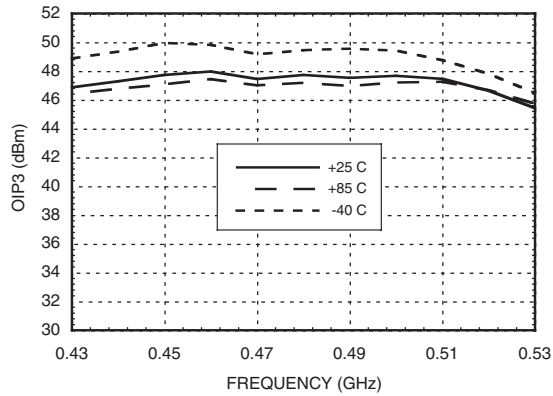

Noise Figure vs. Temperature @ 470 MHz

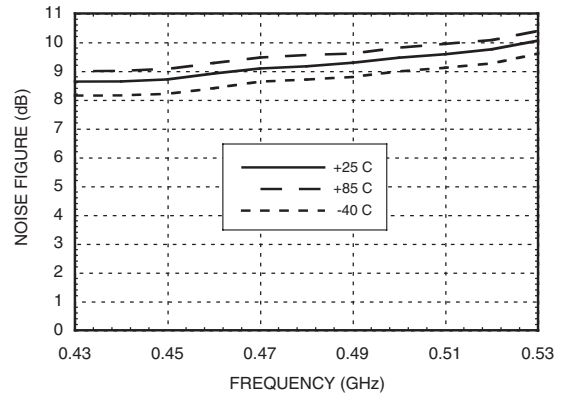

Reverse Isolation vs. Temperature @ 470 MHz

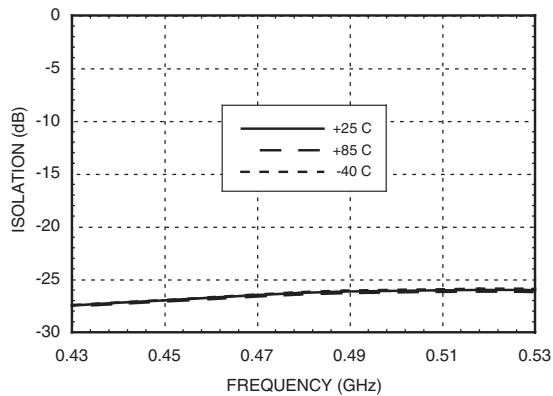

Gain, Power & IP3 vs. Supply Voltage @ 470 MHz

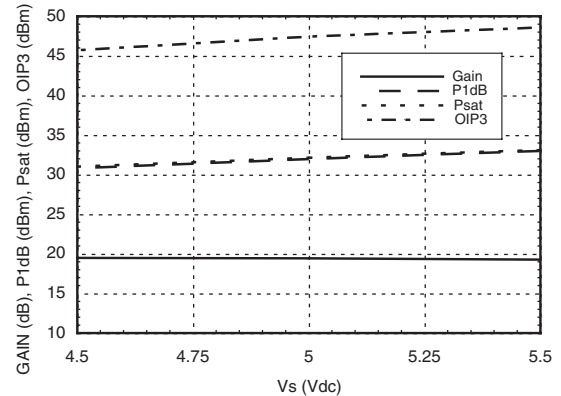

Power Compression @ 470 MHz

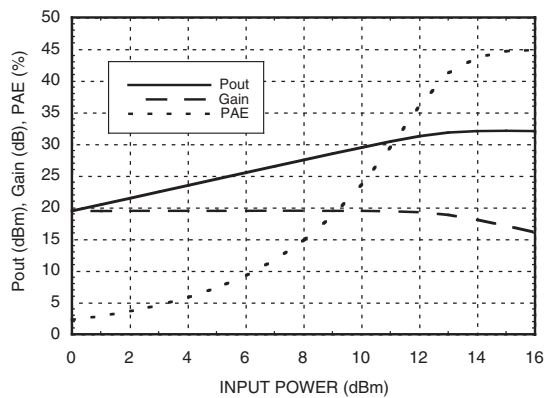

ACPR vs. Supply Voltage @ 470 MHz W-CDMA, 64 DPCH

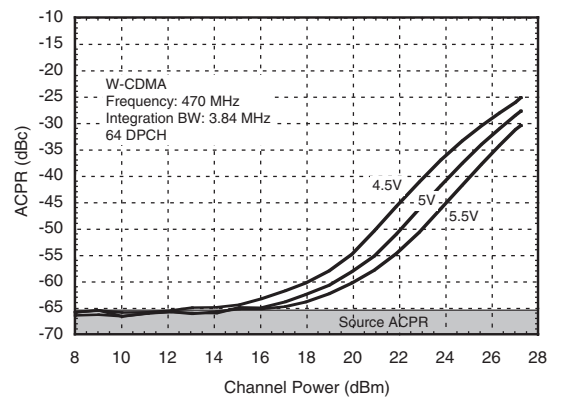



Broadband Gain & Return Loss @ 900 MHz

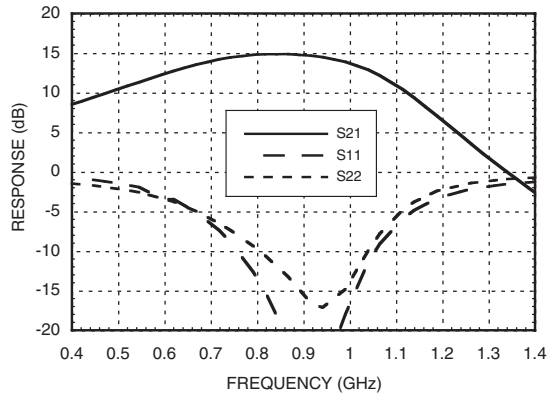

Gain vs. Temperature @ 900 MHz

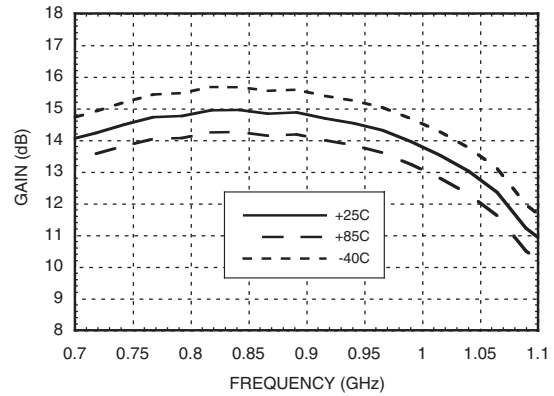

Input Return Loss vs. Temperature @ 900 MHz

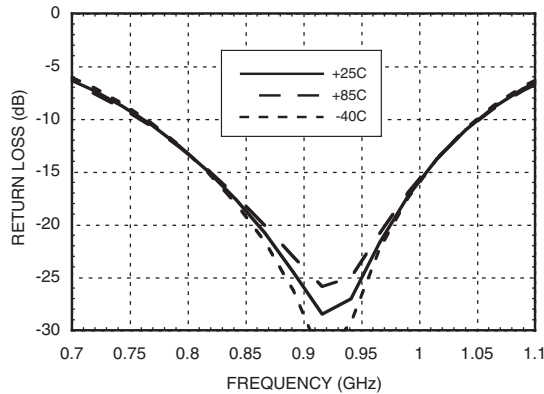

Output Return Loss vs. Temperature @ 900 MHz

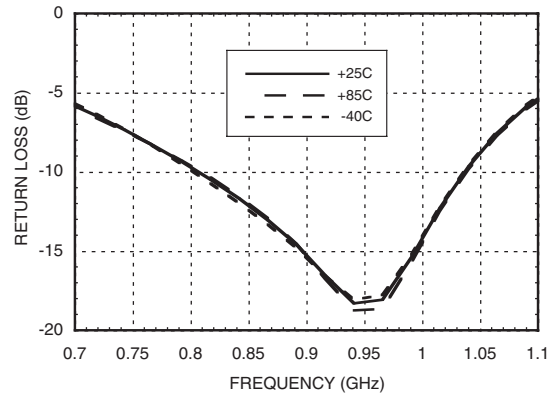

P1dB vs. Temperature @ 900 MHz

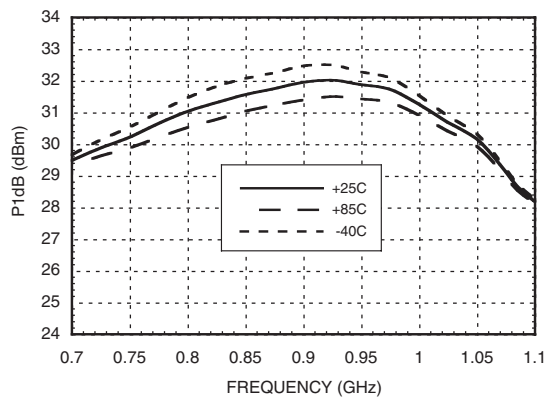

Psat vs. Temperature @ 900 MHz

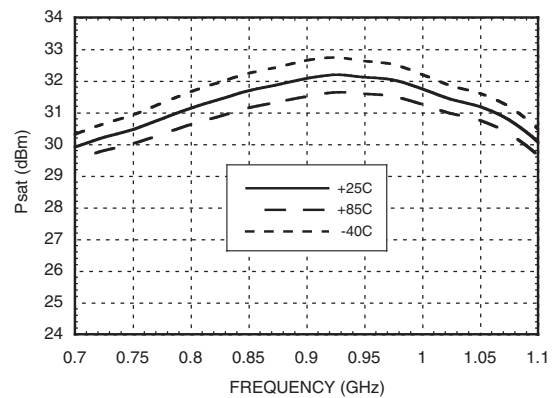

Output IP3 vs. Temperature @ 900 MHz

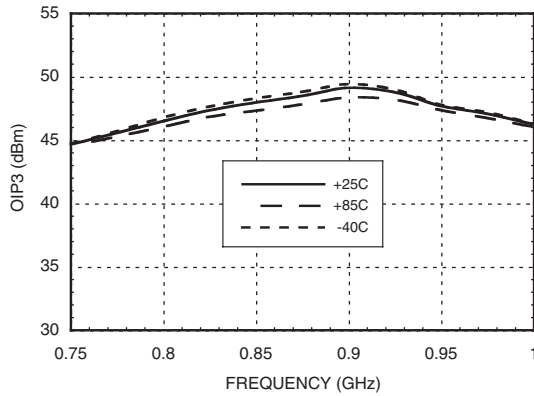

Noise Figure vs. Temperature @ 900 MHz

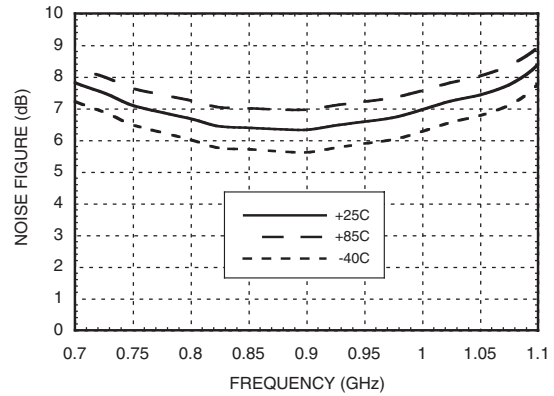

Reverse Isolation vs. Temperature @ 900 MHz

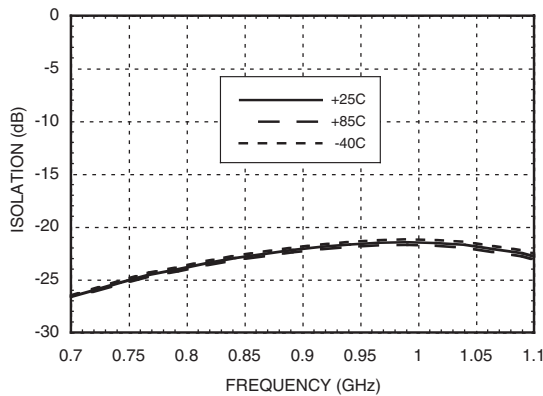

Gain, Power & IP3 vs. Supply Voltage @ 900 MHz

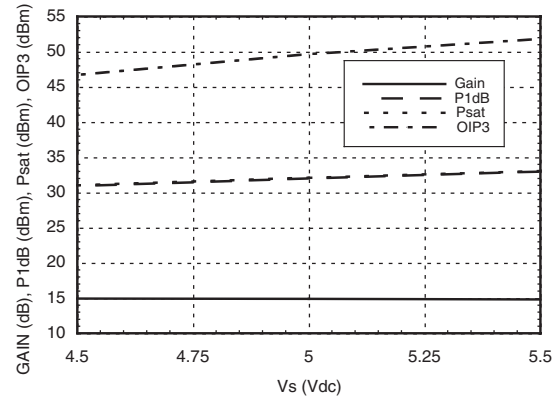

Power Compression @ 900 MHz

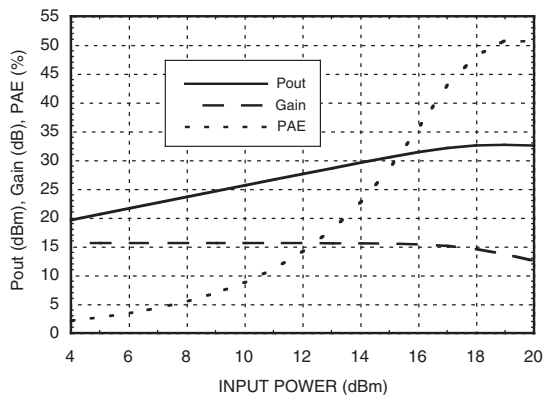

ACPR vs. Supply Voltage @ 910 MHz CDMA IS95, 9 Channels Forward

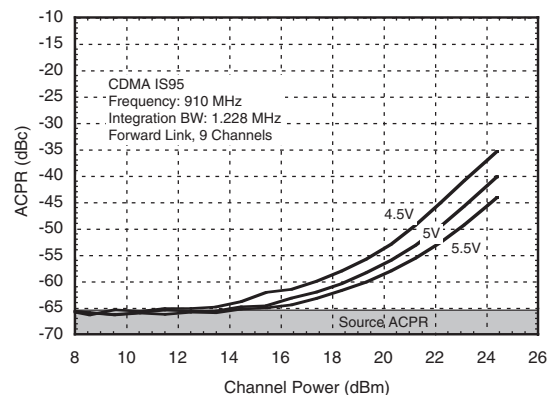



Broadband Gain & Return Loss @ 1900 MHz

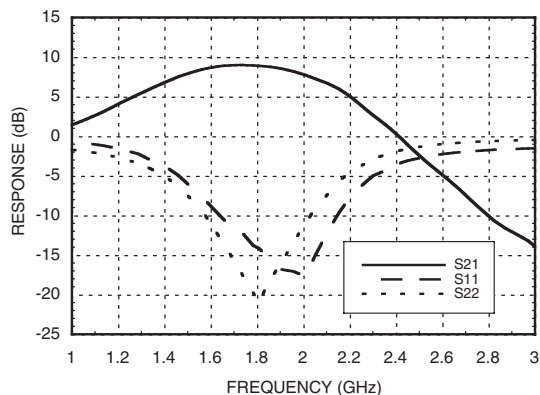

Gain vs. Temperature @ 1900 MHz

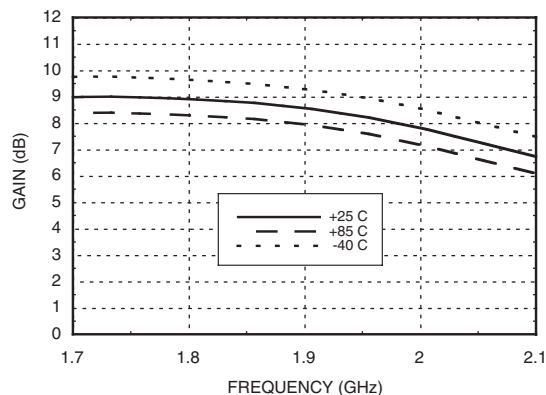

Input Return Loss vs. Temperature @ 1900 MHz

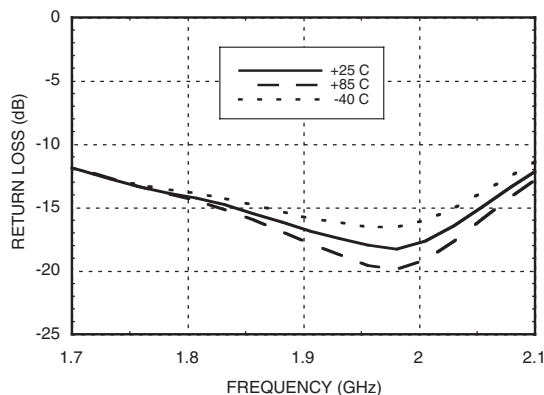

Output Return Loss vs. Temperature @ 1900 MHz

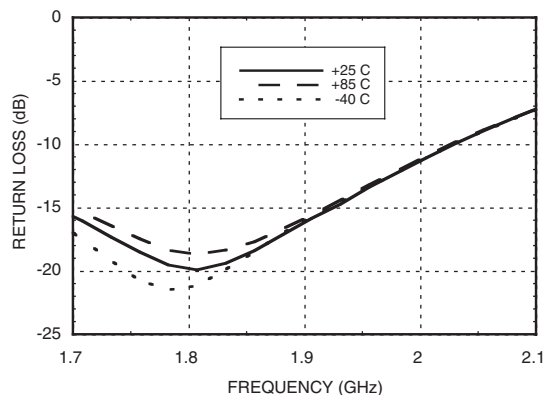

P1dB vs. Temperature @ 1900 MHz

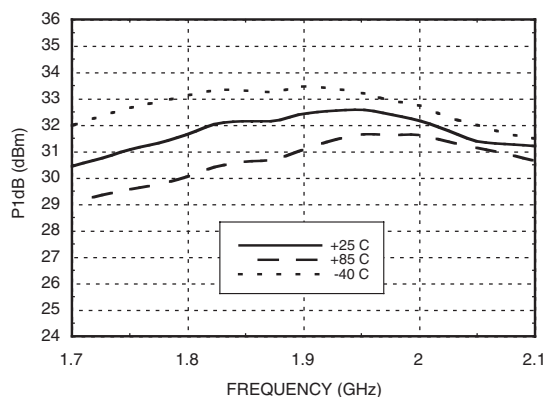

Psat vs. Temperature @ 1900 MHz

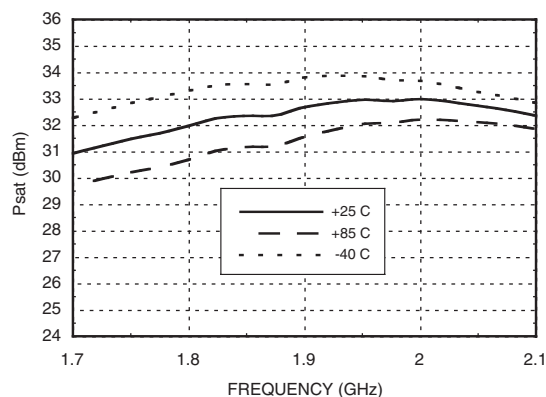

Noise Figure vs. Temperature @ 1900 MHz

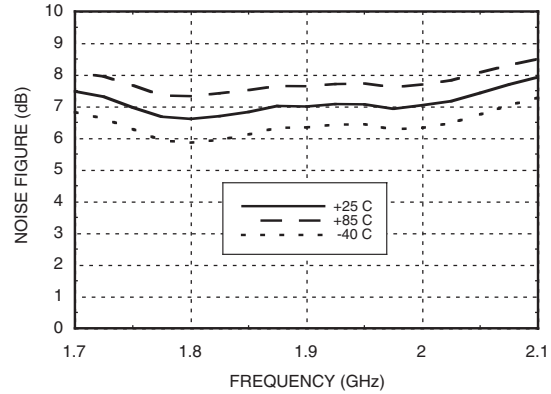

Output IP3 vs. Temperature @ 1900 MHz

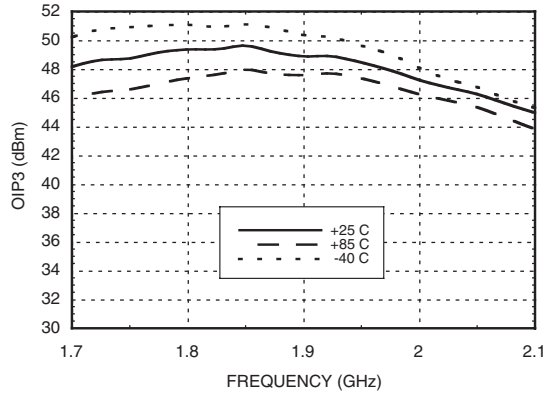

Gain, Power & IP3 vs. Supply Voltage @ 1900 MHz

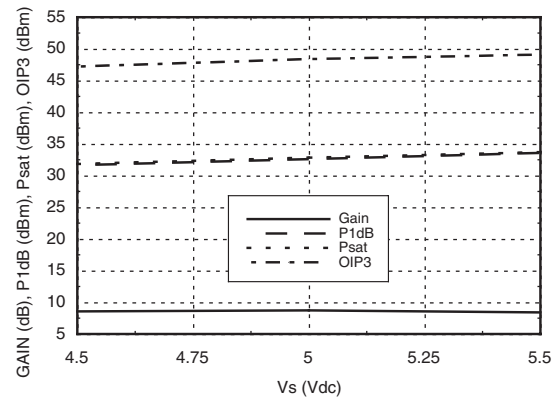

Reverse Isolation vs. Temperature @ 1900 MHz

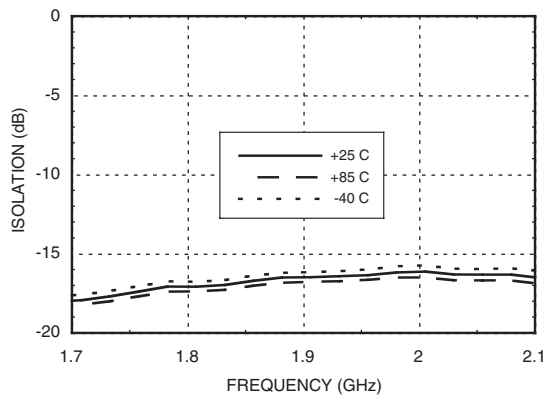

ACPR vs. Supply Voltage @ 1960 MHz CDMA 2000, 9 Channels Forward

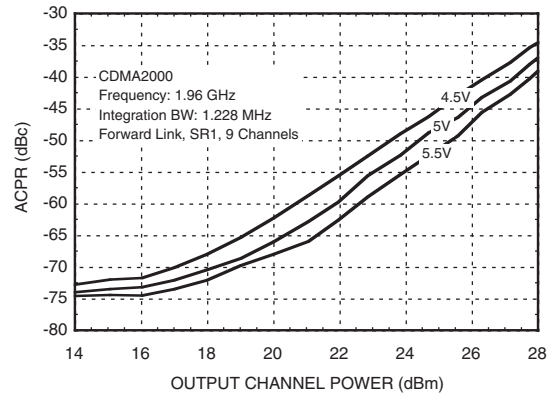

Power Compression @ 1900 MHz

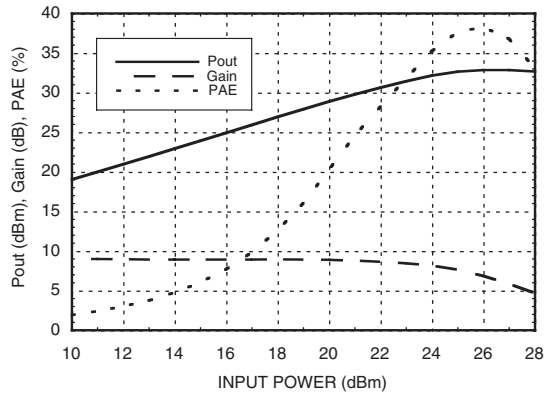



Broadband Gain & Return Loss @ 2100 MHz

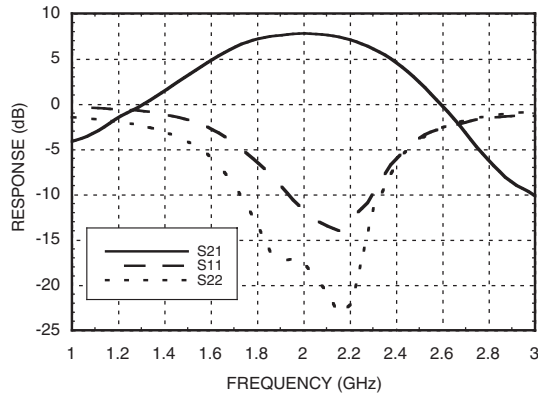

Gain vs. Temperature @ 2100 MHz

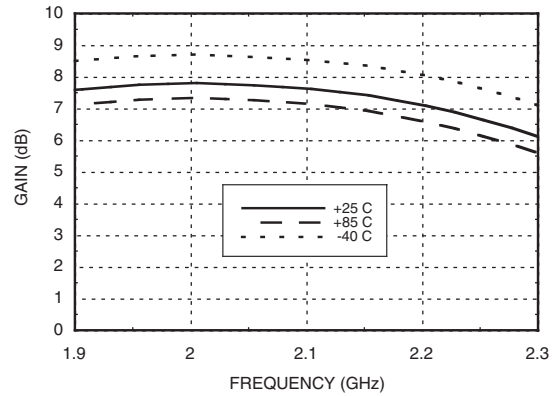

Input Return Loss vs. Temperature @ 2100 MHz

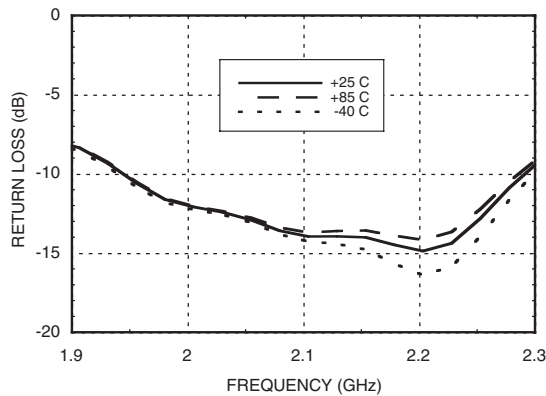

Output Return Loss vs. Temperature @ 2100 MHz

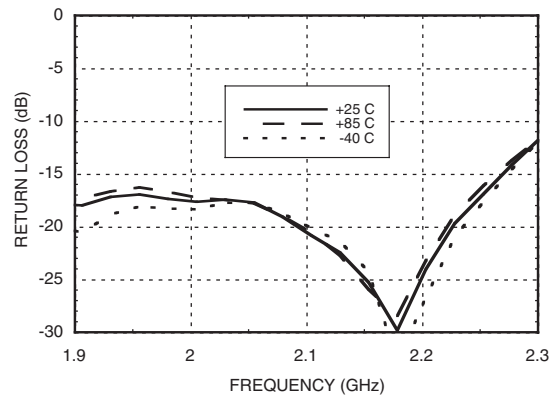

P1dB vs. Temperature @ 2100 MHz

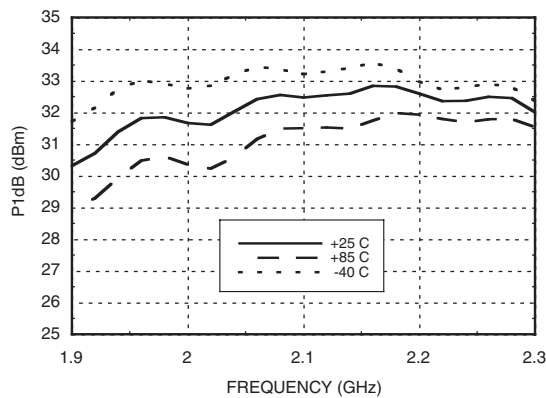

Psat vs. Temperature @ 2100 MHz

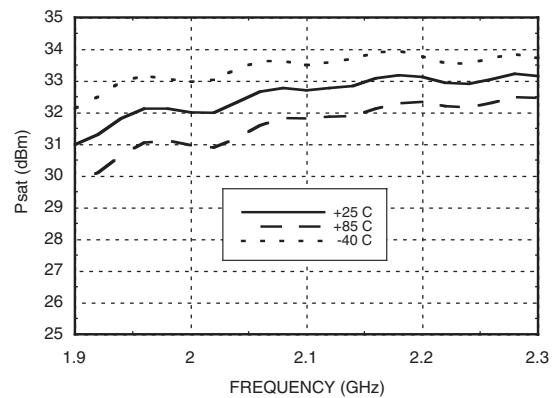

Output IP3 vs. Temperature @ 2100 MHz

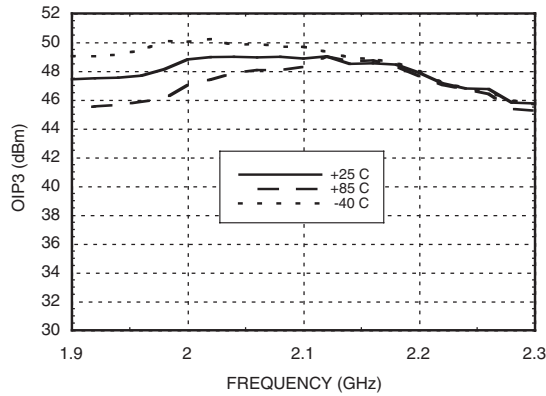

Noise Figure vs. Temperature @ 2100 MHz

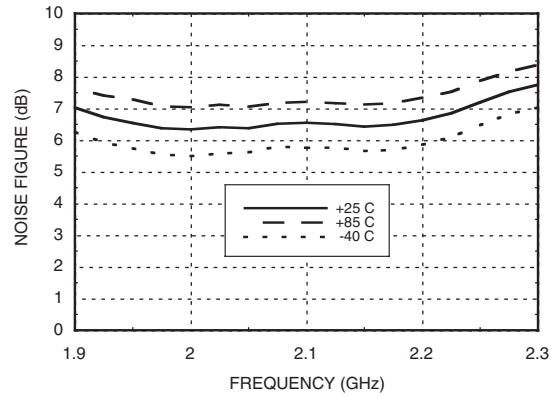

Reverse Isolation vs. Temperature @ 2100 MHz

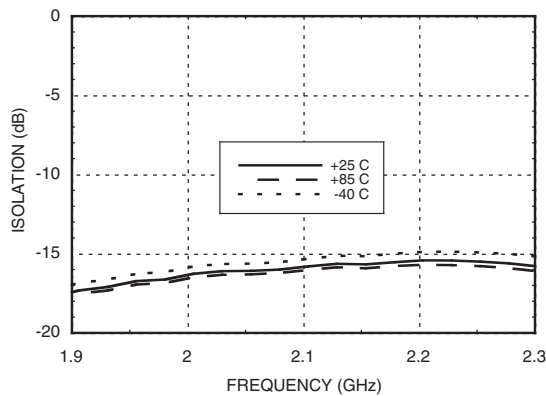

Gain, Power & IP3 vs. Supply Voltage @ 2100 MHz

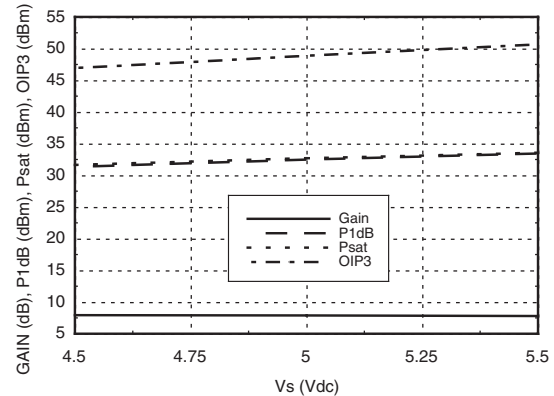

Power Compressions @ 2100 MHz

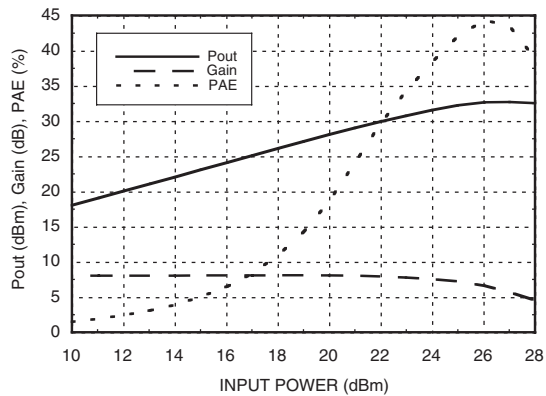

ACPR vs. Supply Voltage @ 2140 MHz W-CDMA, 64 DPCH

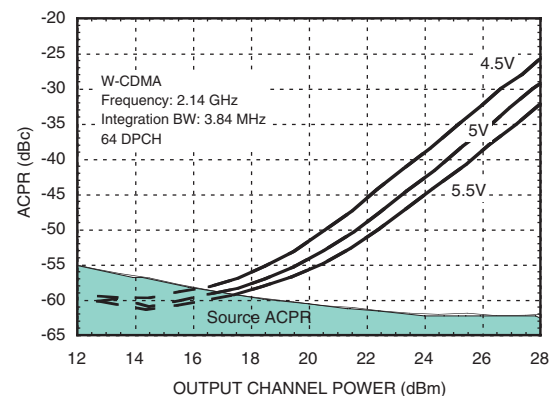

Power Dissipation

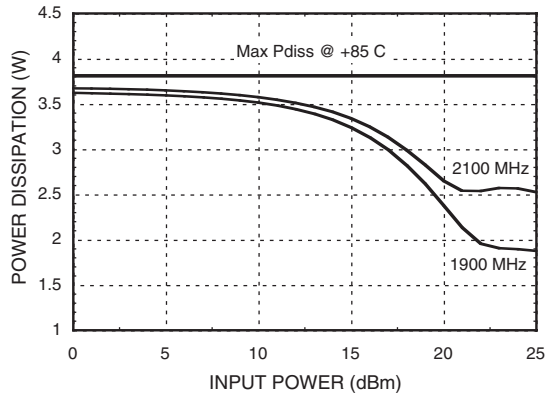

Absolute Maximum Ratings

| | |
|---|----------------|
| Collector Bias Voltage (Vcc) | +6.0 Vdc |
| RF Input Power (RFIn)(Vs +5.0 Vdc) | +32 dBm |
| Junction Temperature | 150 °C |
| Continuous Pdiss (T = 85 °C) (derate 58.5 mW/°C above 85 °C) | 3.8 W |
| Thermal Resistance (junction to ground paddle) | 17.1 °C/W |
| Storage Temperature | -65 to +150 °C |
| Operating Temperature | -40 to +85 °C |



ELECTROSTATIC SENSITIVE DEVICE
OBSERVE HANDLING PRECAUTIONS

Outline Drawing

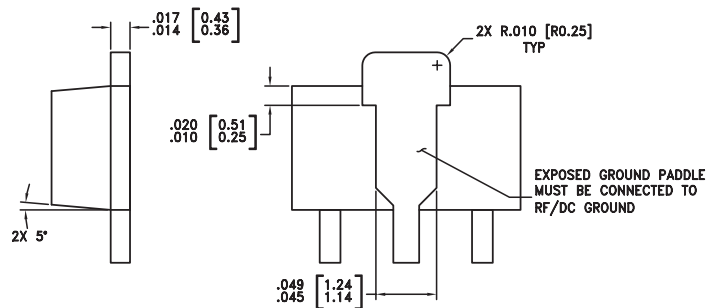
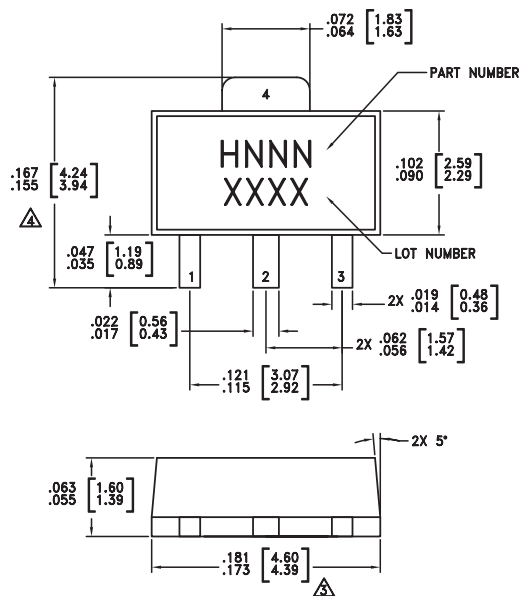

NOTES:

- LEADFRAME MATERIAL: COPPER ALLOY
- DIMENSIONS ARE IN INCHES [MILLIMETERS]
- DIMENSION DOES NOT INCLUDE MOLDFLASH OF 0.15mm PER SIDE.
- DIMENSION DOES NOT INCLUDE MOLDFLASH OF 0.25mm PER SIDE.
- ALL GROUND LEADS AND GROUND PADDLE MUST BE SOLDERED TO PCB RF GROUND.



Package Information

| Part Number | Package Body Material | Lead Finish | MSL Rating | Package Marking ^[3] |
|-------------|--|---------------|---------------------|--------------------------------|
| HMC453ST89 | Low Stress Injection Molded Plastic | Sn/Pb Solder | MSL1 ^[1] | H453 XXXX |
| HMC453ST89E | RoHS-compliant Low Stress Injection Molded Plastic | 100% matte Sn | MSL1 ^[2] | H453 XXXX |

[1] Max peak reflow temperature of 235 °C
 [2] Max peak reflow temperature of 260 °C
 [3] 4-Digit lot number XXXX

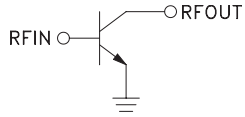

Pin Descriptions

| Pin Number | Function | Description | Interface Schematic |
|------------|----------|---|---|
| 1 | RFIN | This pin is DC coupled. Off chip matching components are required. See Application Circuit herein. |  |
| 3 | RFOUT | RF output and DC Bias input for the amplifier. Off chip matching components are required. See Application Circuit herein. | |
| 2, 4 | GND | These pins & package bottom must be connected to RF/DC ground. |  |

400 MHz Application Circuit

This circuit was used to specify the performance for 400-410 MHz operation. Contact the HMC Applications Group for assistance in optimizing performance for your application.

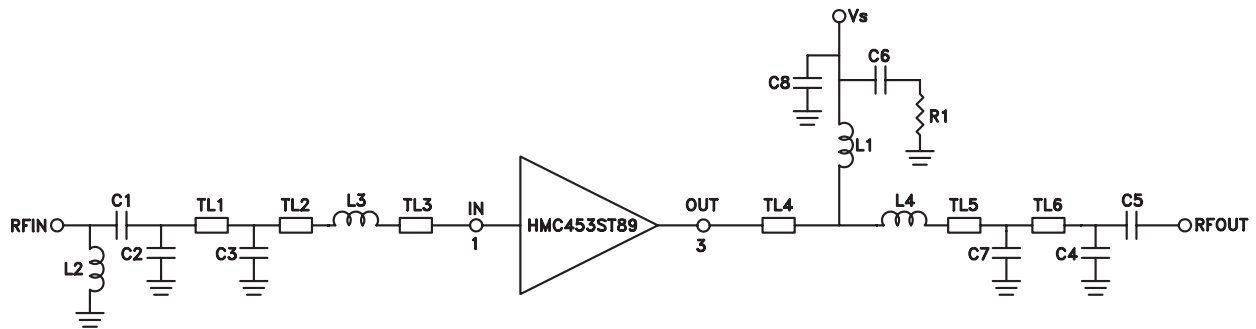

| | TL1 | TL2 | TL3 | TL4 | TL5 | TL6 |
|---|--------|--------|--------|--------|--------|--------|
| Impedance | 50 Ohm | 50 Ohm | 50 Ohm | 50 Ohm | 50 Ohm | 50 Ohm |
| Physical Length | 0.16" | 0.04" | 0.06" | 0.21" | 0.04" | 0.10" |
| Electrical Length | 4° | 1° | 1° | 5° | 1° | 2° |
| PCB Material: 10 mil Rogers 4350, Er = 3.48 | | | | | | |

| Recommended Component Values | |
|------------------------------|---------|
| C1, C4 | 10 pF |
| C2, C3 | 8.2 pF |
| C5 | 39 pF |
| C6 | 100 pF |
| C7 | 12 pF |
| C8 | 2.2 μF |
| L1 | 47 nH |
| L2 | 40 nH |
| L3 | 4.3 nH |
| L4 | 5.1 nH |
| R1 | 5.1 Ohm |

400 MHz Evaluation PCB

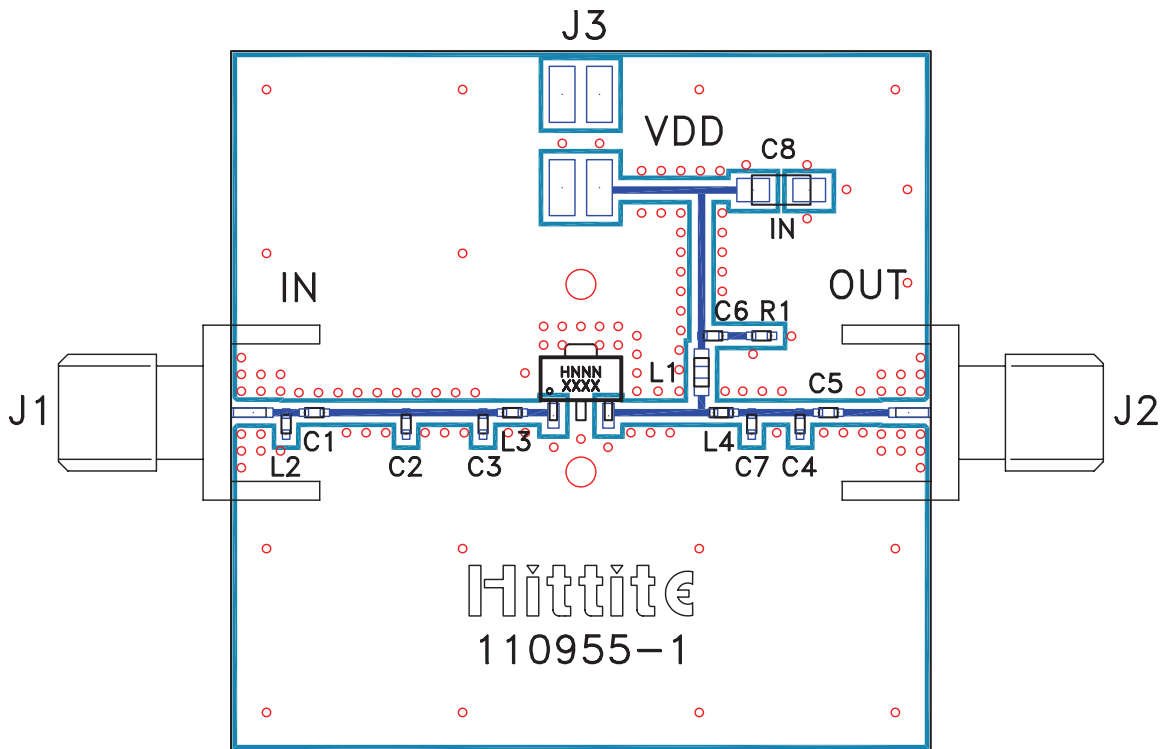

List of Materials for Evaluation PCB 110957-400 [1]

| Item | Description |
|---------|--|
| J1 - J2 | PCB Mount SMA Connector |
| J3 | 2 mm DC Header |
| C1, C4 | 10 pF Capacitor, 0402 Pkg. |
| C2, C3 | 8.2 pF Capacitor, 0402 Pkg. |
| C5 | 39 pF Capacitor, 0402 Pkg. |
| C6 | 100 pF Capacitor, 0402 Pkg. |
| C7 | 12 pF Capacitor, 0402 Pkg. |
| C8 | 2.2 μ F Capacitor, Tantalum |
| L1 | 47 nH Inductor, 0603 Pkg. |
| L2 | 40 nH Inductor, 0402 Pkg. |
| L3 | 4.3 nH Inductor, 0402 Pkg. |
| L4 | 5.1 nH Inductor, 0402 Pkg. |
| R1 | 5.1 Ohm Resistor, 0402 Pkg. |
| U1 | HMC453ST89 / HMC453ST89E Linear Amp |
| PCB [2] | 110955 Evaluation PCB, 10 mils |

[1] Reference this number when ordering complete evaluation PCB

[2] Circuit Board Material: Rogers 4350, Er = 3.48

The circuit board used in this application should use RF circuit design techniques. Signal lines should have 50 ohm impedance while the package ground leads and exposed paddle should be connected directly to the ground plane similar to that shown. A sufficient number of VIA holes should be used to connect the top and bottom ground planes. The evaluation board should be mounted to an appropriate heat sink. The evaluation circuit board shown is available from Hittite upon request.

470 MHz Application Circuit

This circuit was used to specify the performance for 450-496 MHz operation. Contact the HMC Applications Group for assistance in optimizing performance for your application.

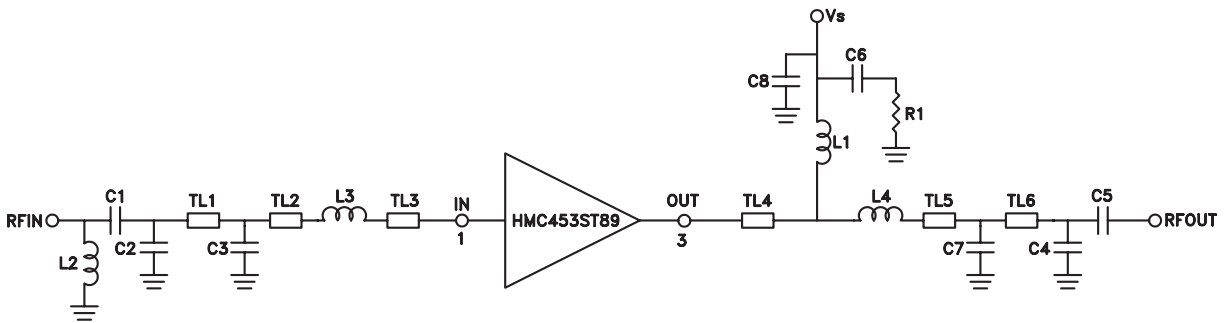

| | TL1 | TL2 | TL3 | TL4 | TL5 | TL6 |
|---|--------|--------|--------|--------|--------|--------|
| Impedance | 50 Ohm | 50 Ohm | 50 Ohm | 50 Ohm | 50 Ohm | 50 Ohm |
| Physical Length | 0.16" | 0.04" | 0.06" | 0.21" | 0.04" | 0.10" |
| Electrical Length | 4° | 1° | 2° | 6° | 1° | 3° |
| PCB Material: 10 mil Rogers 4350, Er = 3.48 | | | | | | |

| Recommended Component Values | |
|------------------------------|---------|
| C1 | 10 pF |
| C2, C3 | 6.8 pF |
| C4 | 12 pF |
| C5 | 39 pF |
| C6 | 100 pF |
| C7 | 5.6 pF |
| C8 | 2.2 μF |
| L1 | 47 nH |
| L2 | 40 nH |
| L3 | 4.7 nH |
| L4 | 2.4 nH |
| R1 | 5.1 Ohm |

470 MHz Evaluation PCB

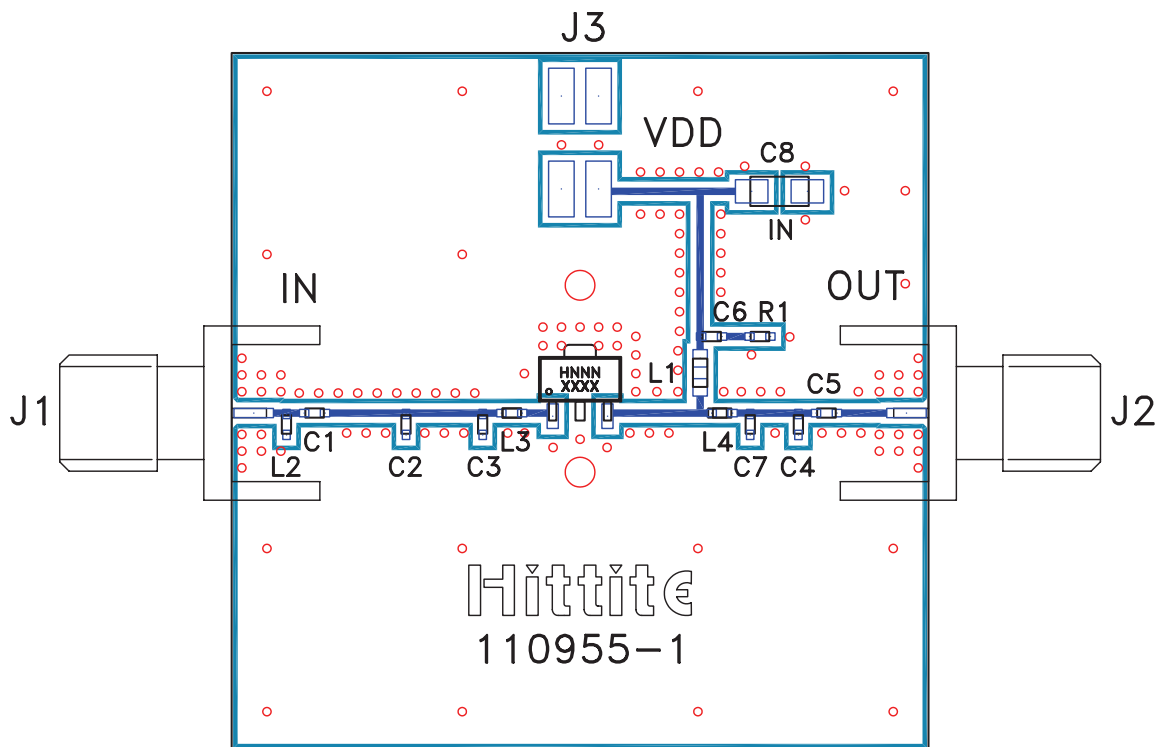

List of Materials for Evaluation PCB 110961-470 [1]

| Item | Description |
|---------|--|
| J1 - J2 | PCB Mount SMA Connector |
| J3 | 2 mm DC Header |
| C1 | 10 pF Capacitor, 0402 Pkg. |
| C2, C3 | 6.8 pF Capacitor, 0402 Pkg. |
| C4 | 12 pF Capacitor, 0402 Pkg. |
| C5 | 39 pF Capacitor, 0402 Pkg. |
| C6 | 100 pF Capacitor, 0402 Pkg. |
| C7 | 5.6 pF Capacitor, 0402 Pkg. |
| C8 | 2.2 μ F Capacitor, Tantalum |
| L1 | 47 nH Inductor, 0603 Pkg. |
| L2 | 40 nH Inductor, 0402 Pkg. |
| L3 | 4.7 nH Inductor, 0402 Pkg. |
| L4 | 2.4 nH Inductor, 0402 Pkg. |
| R1 | 5.1 Ohm Resistor, 0402 Pkg. |
| U1 | HMC453ST89 / HMC453ST89E Linear Amp |
| PCB [2] | 110955 Evaluation PCB, 10 mils |

[1] Reference this number when ordering complete evaluation PCB

[2] Circuit Board Material: Rogers 4350, Er = 3.48

The circuit board used in this application should use RF circuit design techniques. Signal lines should have 50 ohm impedance while the package ground leads and exposed paddle should be connected directly to the ground plane similar to that shown. A sufficient number of VIA holes should be used to connect the top and bottom ground planes. The evaluation board should be mounted to an appropriate heat sink. The evaluation circuit board shown is available from Hittite upon request.

900 MHz Application Circuit

This circuit was used to specify the performance for 810-960 MHz operation. Contact the HMC Applications Group for assistance in optimizing performance for your application.

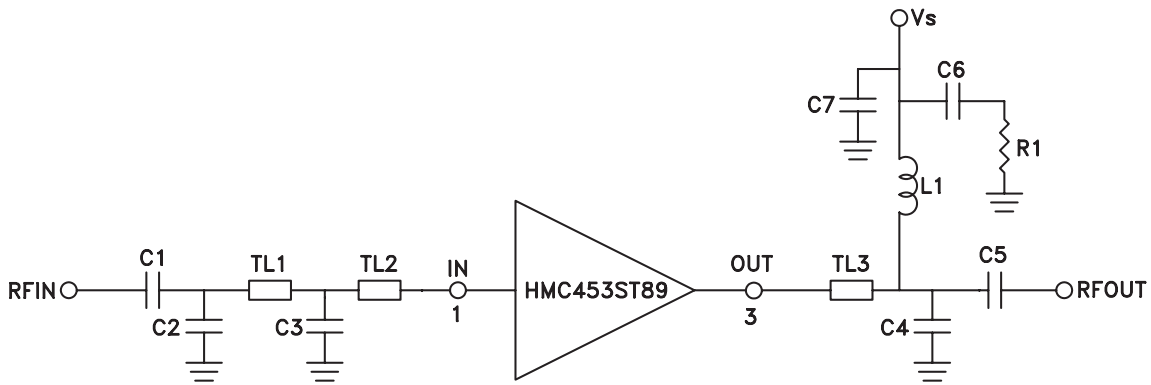

| | TL1 | TL2 | TL3 |
|---|--------|--------|--------|
| Impedance | 50 Ohm | 50 Ohm | 50 Ohm |
| Physical Length | 0.25" | 0.08" | 0.31" |
| Electrical Length | 13° | 4° | 16° |
| PCB Material: 10 mil Rogers 4350, Er = 3.48 | | | |

| Recommended Component Values | |
|------------------------------|---------|
| C1 | 5 pF |
| C2 | 3.3 pF |
| C3 | 2.7 pF |
| C4 | 8.2 pF |
| C5 | 12 pF |
| C6 | 100 pF |
| C7 | 2.2 μF |
| L1 | 15 nH |
| R1 | 5.1 Ohm |

900 MHz Evaluation PCB

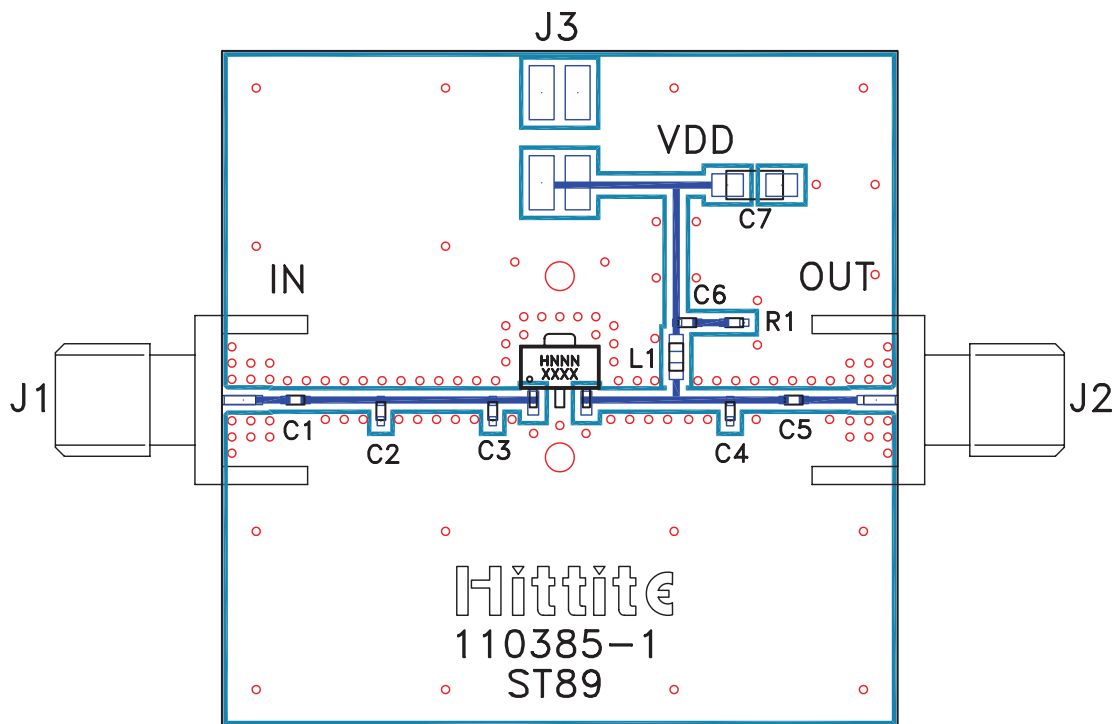

List of Materials for Evaluation PCB 110387-900 [1]

| Item | Description |
|---------|-------------------------------------|
| J1 - J2 | PCB Mount SMA Connector |
| J3 | 2 mm DC Header |
| C1 | 5 pF Capacitor, 0402 Pkg. |
| C2 | 3.3 pF Capacitor, 0402 Pkg. |
| C3 | 2.7 pF Capacitor, 0402 Pkg. |
| C4 | 8.2 pF Capacitor, 0402 Pkg. |
| C5 | 12 pF Capacitor, 0402 Pkg. |
| C6 | 100 pF Capacitor, 0402 Pkg. |
| C7 | 2.2 μ F Capacitor, Tantalum |
| L1 | 15 nH Inductor, 0603 Pkg. |
| R1 | 5.1 Ohm Resistor, 0402 Pkg. |
| U1 | HMC453ST89 / HMC453ST89E Linear Amp |
| PCB [2] | 110385 Evaluation PCB, 10 mils |

[1] Reference this number when ordering complete evaluation PCB

[2] Circuit Board Material: Rogers 4350, Er = 3.48

The circuit board used in this application should use RF circuit design techniques. Signal lines should have 50 ohm impedance while the package ground leads and exposed paddle should be connected directly to the ground plane similar to that shown. A sufficient number of VIA holes should be used to connect the top and bottom ground planes. The evaluation board should be mounted to an appropriate heat sink. The evaluation circuit board shown is available from Hittite upon request.

1900 MHz Application Circuit

This circuit was used to specify the performance for 1710-1990 MHz operation. Contact the HMC Applications Group for assistance in optimizing performance for your application.

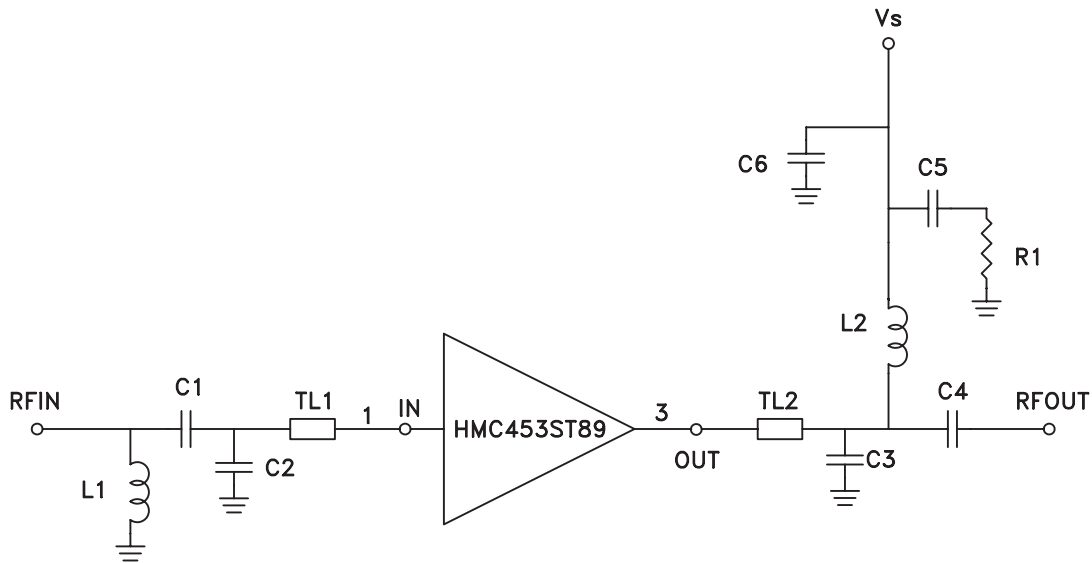

| | TL1 | TL2 |
|---|--------|--------|
| Impedance | 50 Ohm | 50 Ohm |
| Physical Length | 0.04" | 0.07" |
| Electrical Length | 4° | 8° |
| PCB Material: 10 mil Rogers 4350, Er = 3.48 | | |

| Recommended Component Values | |
|------------------------------|---------|
| C1 | 1.2 pF |
| C2 | 1.5 pF |
| C3 | 3.9 pF |
| C4 | 15 pF |
| C5 | 100 pF |
| C6 | 2.2 μF |
| L1 | 20 nH |
| L2 | 12 nH |
| R1 | 5.1 Ohm |

1900 MHz Evaluation PCB

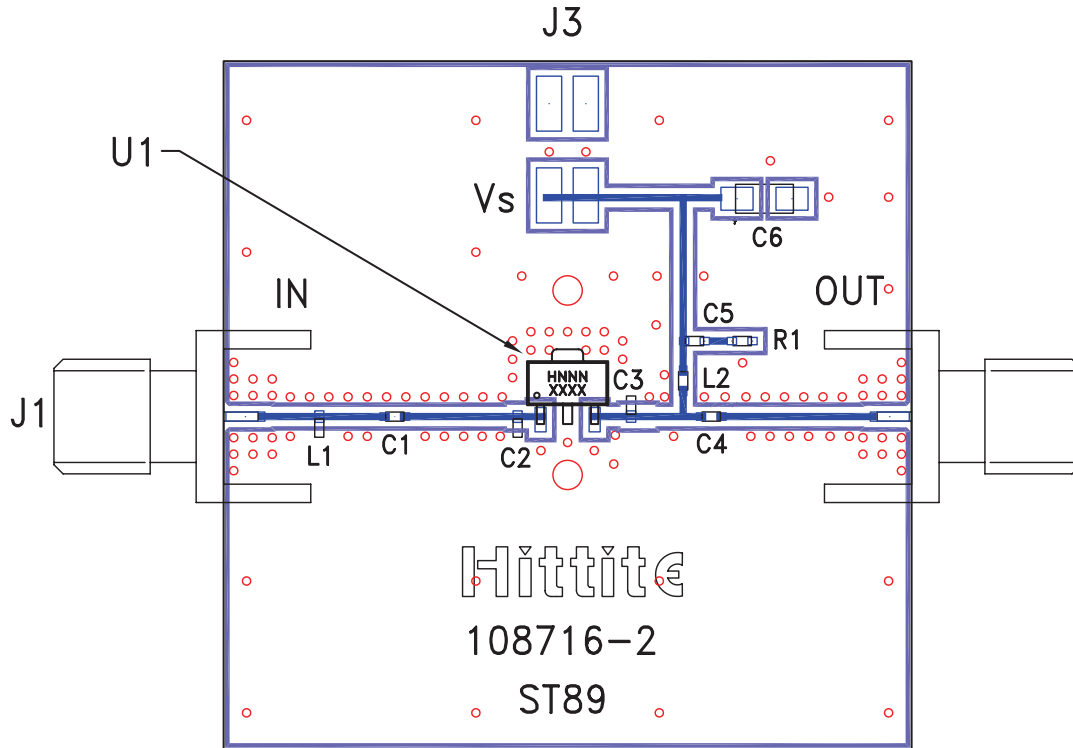

List of Materials for Evaluation PCB 108718-1900 [1]

| Item | Description |
|---------|-------------------------------------|
| J1 - J2 | PCB Mount SMA Connector |
| J3 | 2 mm DC Header |
| C1 | 1.2 pF Capacitor, 0402 Pkg. |
| C2 | 1.5 pF Capacitor, 0402 Pkg. |
| C3 | 3.9 pF Capacitor, 0402 Pkg. |
| C4 | 15 pF Capacitor, 0402 Pkg. |
| C5 | 100 pF Capacitor, 0402 Pkg. |
| C6 | 2.2 μ F Capacitor, Tantalum |
| L1 | 20 nH Inductor, 0402 Pkg. |
| L2 | 12 nH Inductor, 0402 Pkg. |
| R1 | 5.1 Ohm Resistor, 0402 Pkg. |
| U1 | HMC453ST89 / HMC453ST89E Linear Amp |
| PCB [2] | 108716 Evaluation PCB, 10 mils |

The circuit board used in this application should use RF circuit design techniques. Signal lines should have 50 ohm impedance while the package ground leads and exposed paddle should be connected directly to the ground plane similar to that shown. A sufficient number of VIA holes should be used to connect the top and bottom ground planes. The evaluation board should be mounted to an appropriate heat sink. The evaluation circuit board shown is available from Hittite upon request.

[1] Reference this number when ordering complete evaluation PCB

[2] Circuit Board Material: Rogers 4350, Er = 3.48

2100 MHz Application Circuit

This circuit was used to specify the performance for 2010-2170 MHz operation. Contact the HMC Applications Group for assistance in optimizing performance for your application.

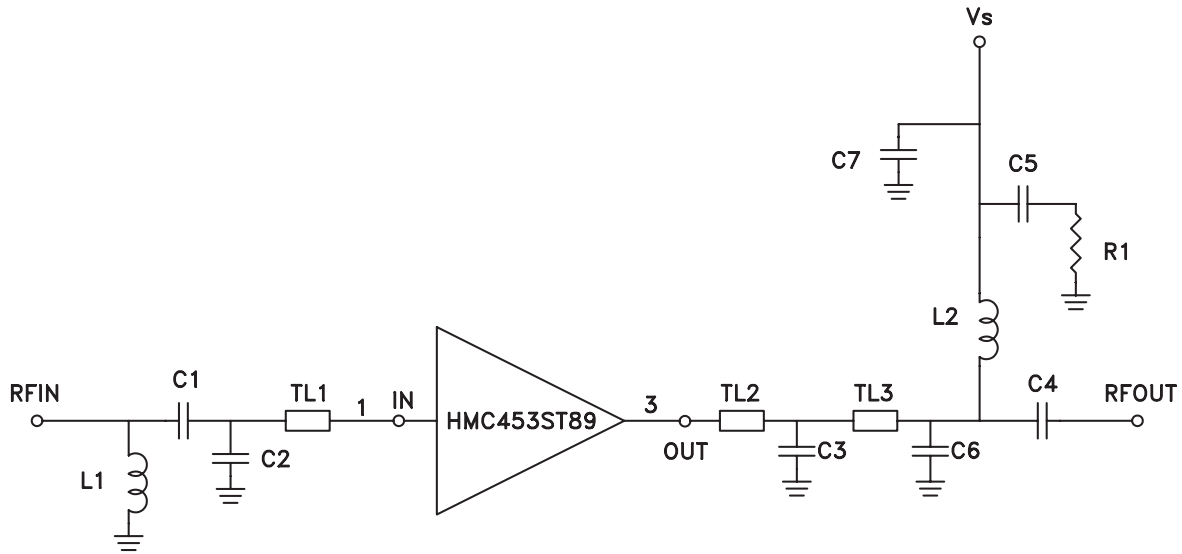

Note: C2 and C3 should be placed as close to pins as possible.

| | TL1 | TL2 | TL3 |
|---|--------|--------|--------|
| Impedance | 50 Ohm | 50 Ohm | 50 Ohm |
| Physical Length | 0.04" | 0.04" | 0.04" |
| Electrical Length | 5° | 5° | 5° |
| PCB Material: 10 mil Rogers 4350, Er = 3.48 | | | |

| Recommended Component Values | |
|------------------------------|---------|
| C1 | 0.8 pF |
| C2 | 1 pF |
| C3 | 3.3 pF |
| C4 | 15 pF |
| C5 | 100 pF |
| C6 | 0.5 pF |
| C7 | 2.2 μF |
| L1 | 20 nH |
| L2 | 12 nH |
| R1 | 5.1 Ohm |

2100 MHz Evaluation PCB

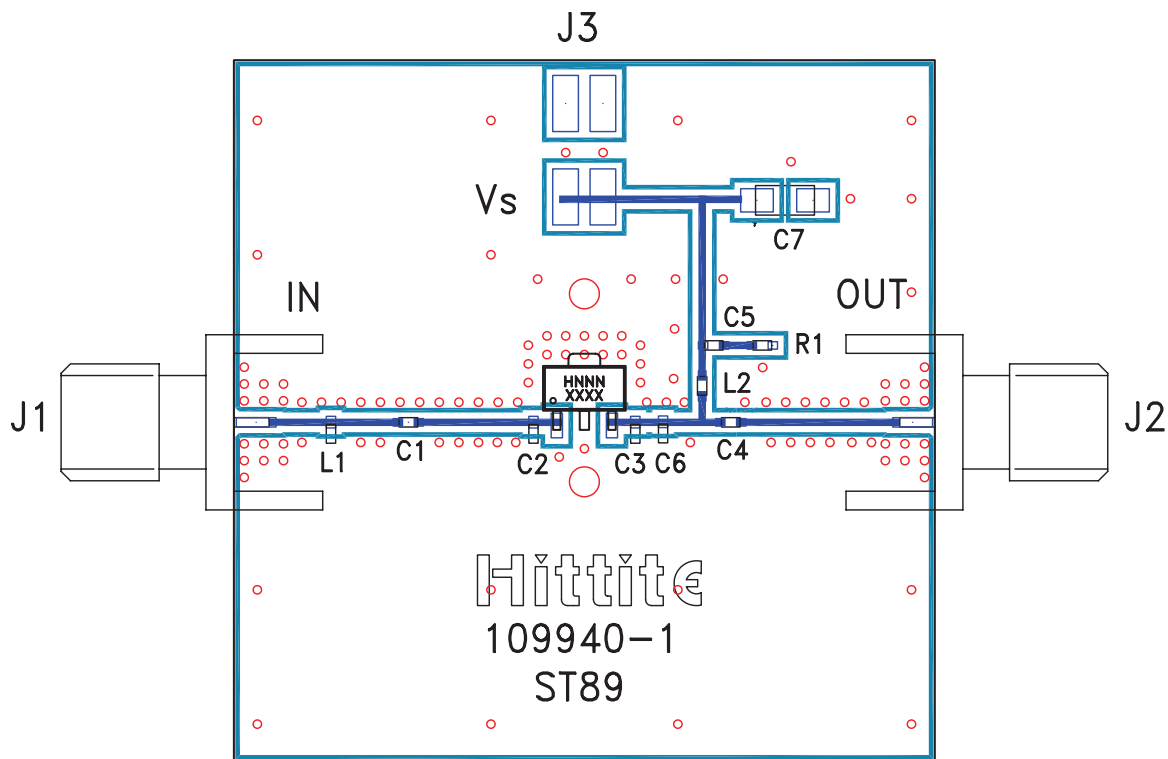

List of Materials for Evaluation PCB 109942-2100 [1]

| Item | Description |
|---------|--|
| J1 - J2 | PCB Mount SMA Connector |
| J3 | 2 mm DC Header |
| C1 | 0.8 pF Capacitor, 0402 Pkg. |
| C2 | 1 pF Capacitor, 0402 Pkg. |
| C3 | 3.3 pF Capacitor, 0402 Pkg. |
| C4 | 15 pF Capacitor, 0402 Pkg. |
| C5 | 100 pF Capacitor, 0402 Pkg. |
| C6 | 0.5 pF Capacitor, 0402 Pkg. |
| C7 | 2.2 μ F Capacitor, Tantalum |
| L1 | 20 nH Inductor, 0402 Pkg. |
| L2 | 12 nH Inductor, 0402 Pkg. |
| R1 | 5.1 Ohm Resistor, 0402 Pkg. |
| U1 | HMC453ST89 / HMC453ST89E Linear Amp |
| PCB [2] | 109940 Evaluation PCB, 10 mils |

[1] Reference this number when ordering complete evaluation PCB

[2] Circuit Board Material: Rogers 4350, Er = 3.48

The circuit board used in this application should use RF circuit design techniques. Signal lines should have 50 ohm impedance while the package ground leads and exposed paddle should be connected directly to the ground plane similar to that shown. A sufficient number of VIA holes should be used to connect the top and bottom ground planes. The evaluation board should be mounted to an appropriate heat sink. The evaluation circuit board shown is available from Hittite upon request.