

**GPS Low Noise Amplifier  
1.5 - 1.7 GHz**

**MAALSS0049  
V1**

**Features**

- High Gain: 20 dB
- Low Noise Figure: 1.5 dB
- Good 50 Ω Input / Output Match
- Single +3 V to +5 V Bias
- Adjustable Current
- Lead-Free SOT-26 Package
- 100% Matte Tin Plating over Copper
- Halogen-Free “Green” Mold Compound
- 260°C Reflow Compatible
- RoHS\* Compliant Version of MAALSS0027

**Description**

M/A-COM’s MAALSS0049 is a GaAs MMIC low noise amplifier in a lead-free SOT-26 surface mount plastic package. It employs a monolithic 2-stage design featuring a convenient 50-ohm input/output impedance that minimizes the number of external components required.

The MAALSS0049 is optimized for the GPS frequency of 1.575 GHz. It operates with a single 3 volt to 5 volt supply and has an off chip resistor that can be used to improve the linearity performance.

The MAALSS0049 is fabricated using M/A-COM’s E/D process to realize low noise and high dynamic range. The process features full passivation for increased performance and reliability.

**Functional Schematic**

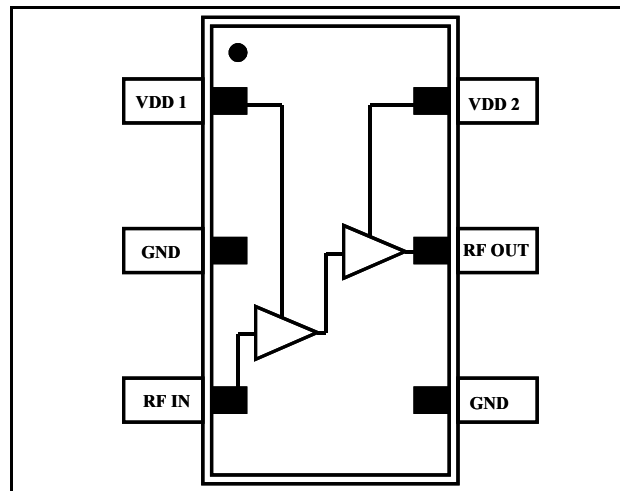

**Pin Configuration**

Pin	Pin Name	Description
1	V <sub>DD1</sub>	Stage 1 Voltage
2	GND	Ground
3	RF IN	RF input
4	GND	Ground
5	RF OUT	RF output
6	V <sub>DD2</sub>	Stage 2 Voltage

**Ordering Information**

Part Number	Package
MAALSS0049	Bulk Packaging
MAALSS0049TR-3000	3000 piece reel
MAALSS0049SMB	Sample Test Board

Note: Reference Application Note M513 for reel size information.

**Absolute Maximum Ratings<sup>1,2</sup>**

Parameter	Absolute Maximum
Input Power	+8 dBm
Operating Voltage	+6 Volts
Operating Temperature	-40°C to +85°C
Storage Temperature	-40°C to +150°C

1. Exceeding any one or combination of these limits may cause permanent damage to this device.
2. M/A-COM does not recommend sustained operation near these survivability limits.

\* Restrictions on Hazardous Substances, European Union Directive 2002/95/EC.

**GPS Low Noise Amplifier  
1.5 - 1.7 GHz**

**MAALSS0049  
V1**

**Electrical Specifications:  $T_A = 25^\circ\text{C}$ ,  $V_{DD} = 3\text{ V}$ ,  $Z_0 = 50\ \Omega$**

Parameter	Test Conditions	Units	Min.	Typ.	Max.
Gain	1.575 GHz	dB	17	20	22
Noise Figure	1.575 GHz	dB	—	1.5	1.9
Input Return Loss	1.575 GHz	dB	—	15	—
Output Return Loss	1.575 GHz	dB	—	15	—
Output 1 dB Compression	1.575 GHz	dBm	—	8.5	—
Output IP3	-28 dBm Input Power, 1 MHz tone separation 1.575 GHz	dBm	12	17	—
Reverse Isolation	1.575 GHz	dB	—	34	—
Current	—	mA	—	9.5	16

**Lead-Free SOT-26 Plastic Package<sup>†</sup>**

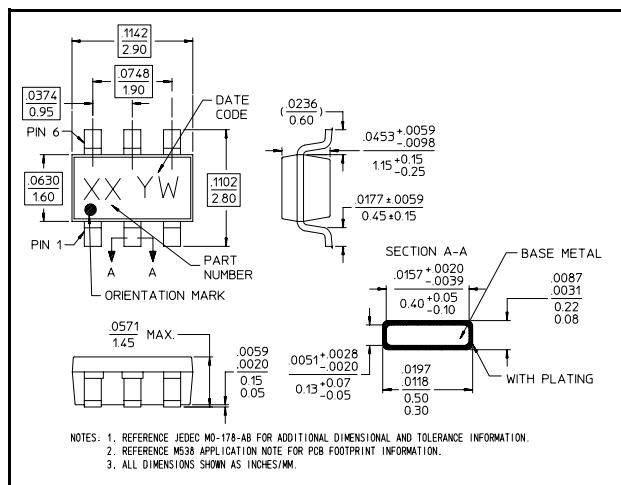

<sup>†</sup> Reference Application Note M538 for lead-free solder reflow recommendations.

**Operating the MAALSS0049**

To operate the device, follow these steps:

1. Ramp  $V_{DD}$  to desired voltage, typically 3 to 5 V.
2. Set RF input.
3. Power down in reverse sequence.

**Handling Procedures**

Please observe the following precautions to avoid damage:

**Static Sensitivity**

Gallium Arsenide Integrated Circuits are sensitive to electrostatic discharge (ESD) and can be damaged by static electricity. Proper ESD control techniques should be used when handling these devices.

**GPS Low Noise Amplifier  
1.5 - 1.7 GHz**

**MAALSS0049  
V1**

**Application Schematic**

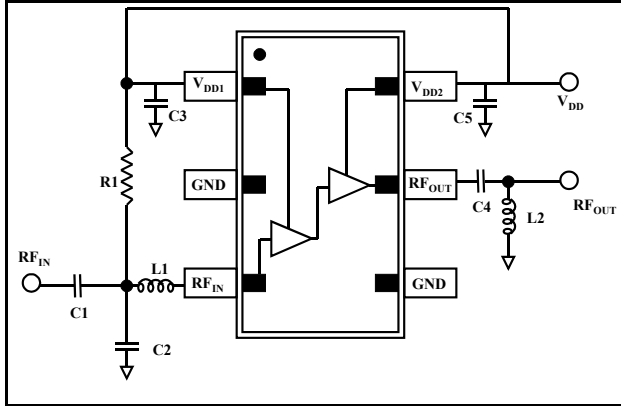

**Recommended PCB Configuration**

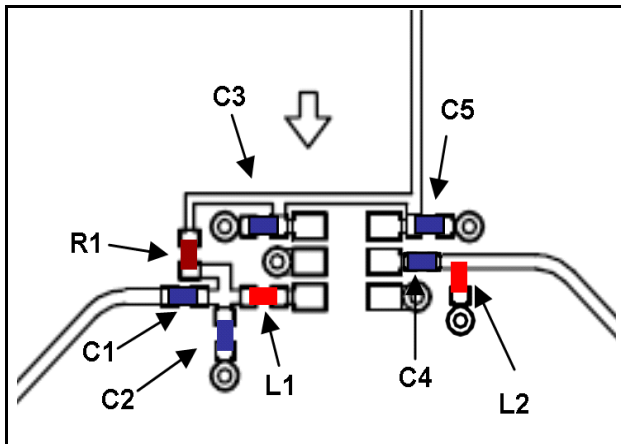

**Recommended Tuning for 1.575 GHz**

Item	Description	Manufacturer
C1	27 pF Capacitor, 0402 Package, 5%	Murata
C2	1.5 pF Capacitor, 0402 Package, 5%	Murata
C3,C5	0.1 $\mu$ F Capacitor, 0402 Package, 5%	Murata
C4	10 pF Capacitor, 0402 Package, 5%	Murata
L1	12 nH Inductor, 0402 Package, 2%	Coilcraft
L2	3.9 nH Inductor, 0402 Package, 2%	Coilcraft
R1	23.7 KOhm Resistor, 0402 Package, 1%	Panasonic

**Typical Performance Curves**

**Broadband Gain and Return Loss @ 3 Volts**

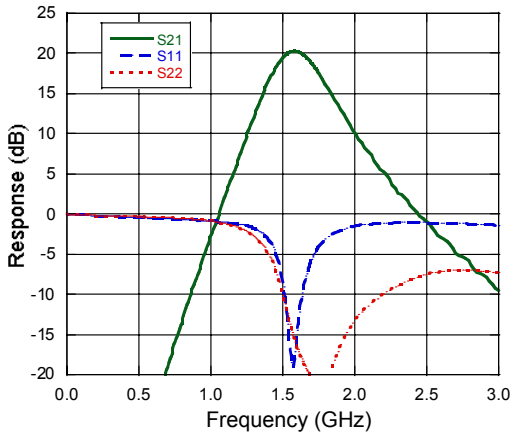

**Broadband Gain and Return Loss @ 5 Volts**

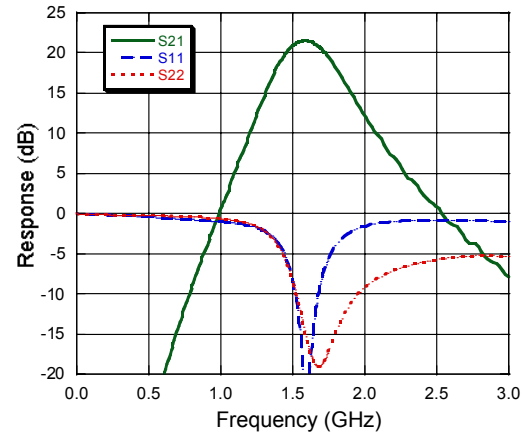

**S21 @ 3 Volts**

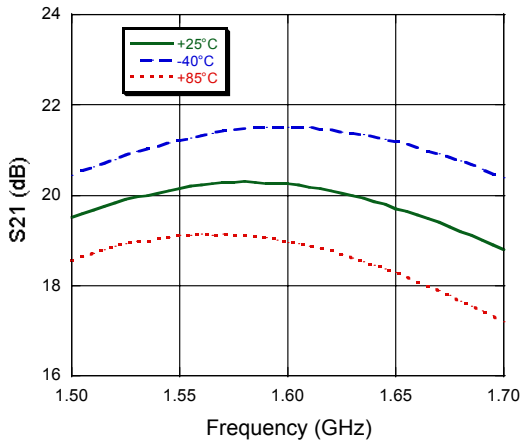

**S21 @ 5 Volts**

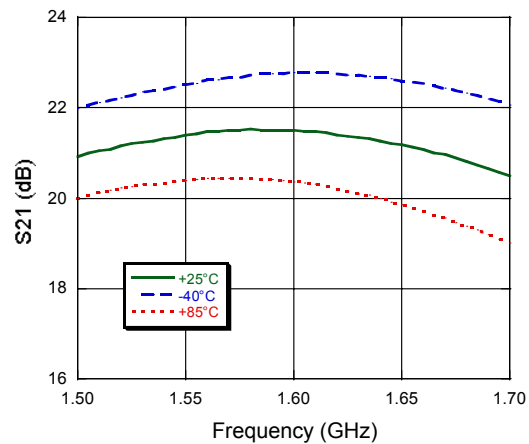

**Noise Figure @ 3 Volts**

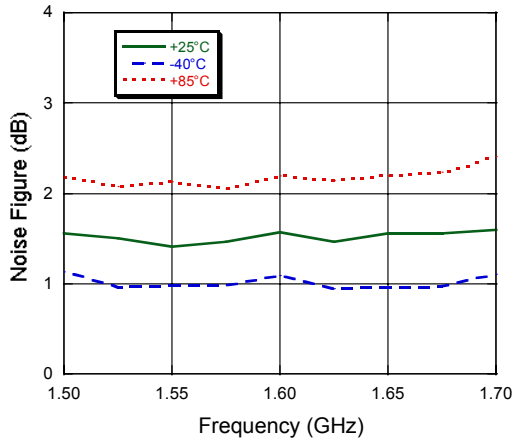

**Noise Figure @ 5 Volts**

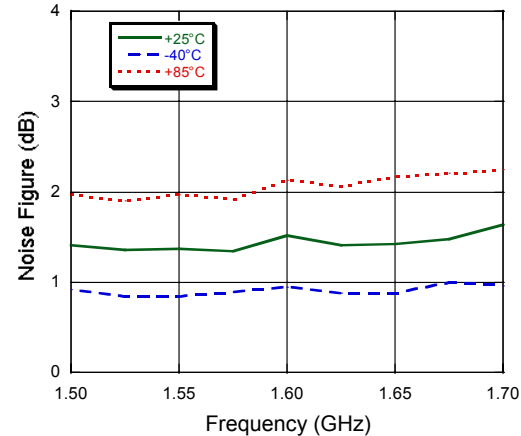

**Typical Performance Curves**

**S11 @ 3 Volts**

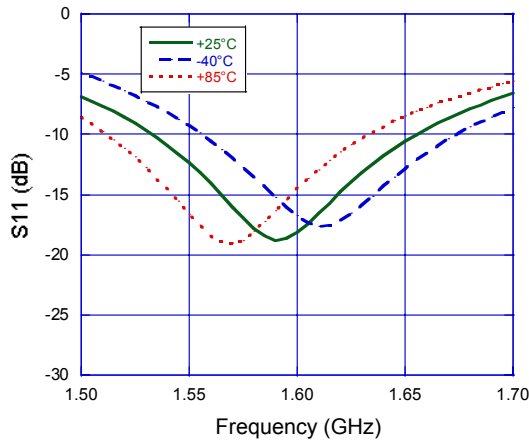

**S11 @ 5 Volts**

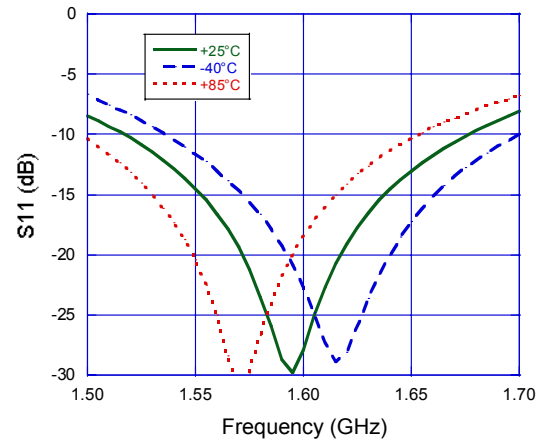

**S22 @ 3 Volts**

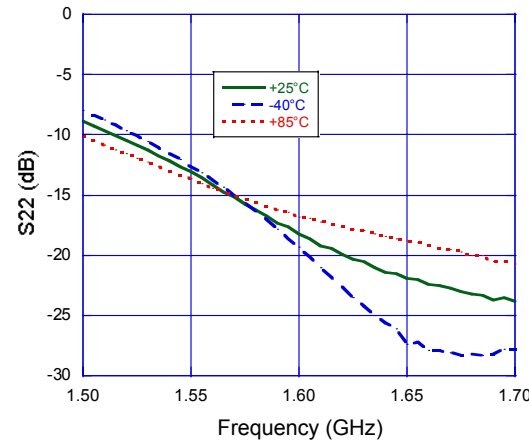

**S22 @ 5 Volts**

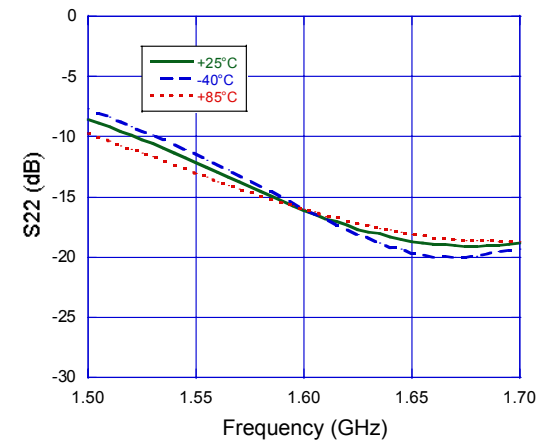

**S12 @ 3 Volts**

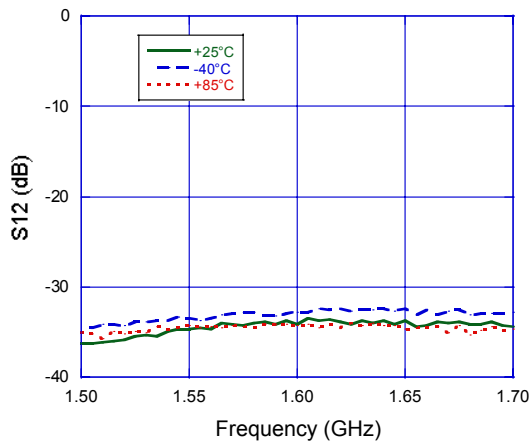

**S12 @ 5 Volts**

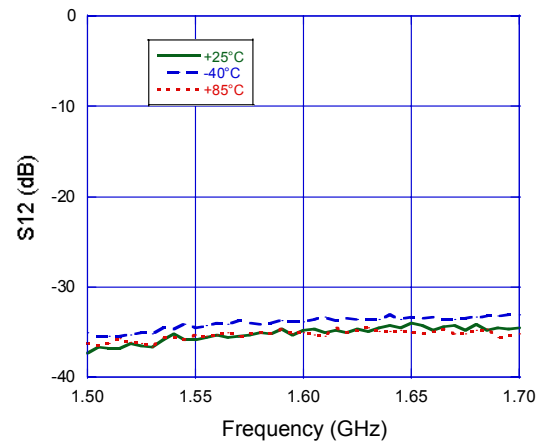

**Typical Performance Curves**

**Output P1dB @ 3 Volts**

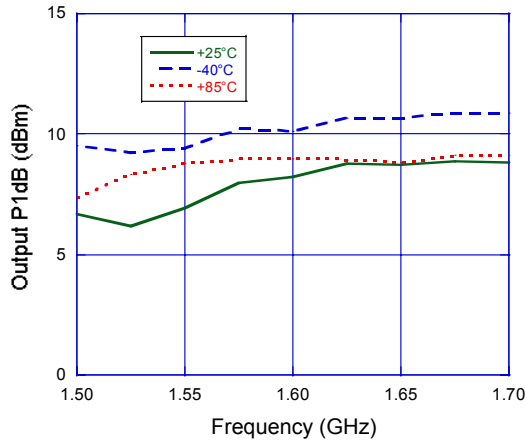

**Output P1dB @ 5 Volts**

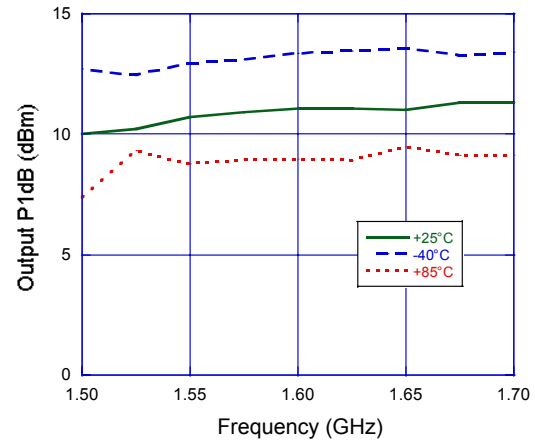

**Output IP3 @ 3 Volts**

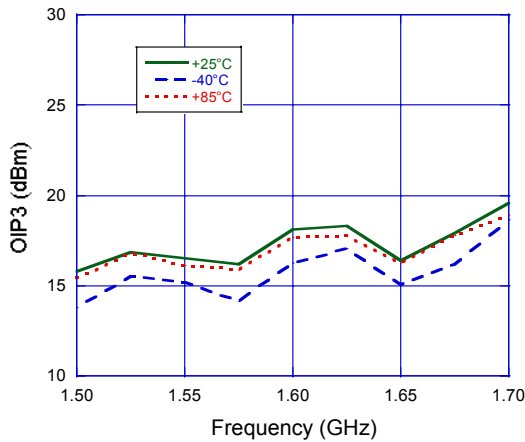

**Output IP3 @ 5 Volts**

