

# MMBF0201NLT1

Preferred Device

## Power MOSFET 300 mAmps, 20 Volts

### N-Channel SOT-23

These miniature surface mount MOSFETs low  $R_{DS(on)}$  assure minimal power loss and conserve energy, making these devices ideal for use in small power management circuitry. Typical applications are dc-dc converters, power management in portable and battery-powered products such as computers, printers, PCMCIA cards, cellular and cordless telephones.

#### Features

- Low  $R_{DS(on)}$  Provides Higher Efficiency and Extends Battery Life
- Miniature SOT-23 Surface Mount Package Saves Board Space
- Pb-Free Package is Available

#### MAXIMUM RATINGS ( $T_J = 25^\circ\text{C}$ unless otherwise noted)

| Rating  | Symbol                     | Value             | Unit               |
|---|----------------------------|-------------------|--------------------|
| Drain-to-Source Voltage   | $V_{DSS}$                  | 20                | Vdc                |
| Gate-to-Source Voltage – Continuous   | $V_{GS}$                   | $\pm 20$          | Vdc                |
| Drain Current<br>– Continuous @ $T_A = 25^\circ\text{C}$<br>– Continuous @ $T_A = 70^\circ\text{C}$<br>– Pulsed Drain Current ( $t_p \leq 10 \mu\text{s}$ ) | $I_D$<br>$I_D$<br>$I_{DM}$ | 300<br>240<br>750 | mAdc               |
| Total Power Dissipation @ $T_A = 25^\circ\text{C}$  | $P_D$                      | 225               | mW                 |
| Operating and Storage Temperature Range   | $T_J, T_{stg}$             | -55 to 150        | $^\circ\text{C}$   |
| Thermal Resistance, Junction-to-Ambient   | $R_{\theta JA}$            | 556               | $^\circ\text{C/W}$ |
| Maximum Lead Temperature for Soldering Purposes, 1/8" from case for 10 seconds  | $T_L$                      | 260               | $^\circ\text{C}$   |

Maximum ratings are those values beyond which device damage can occur. Maximum ratings applied to the device are individual stress limit values (not normal operating conditions) and are not valid simultaneously. If these limits are exceeded, device functional operation is not implied, damage may occur and reliability may be affected.



ON Semiconductor®

<http://onsemi.com>

**300 mAmps – 20 Volts**  
 **$R_{DS(on)} = 1 \Omega$**

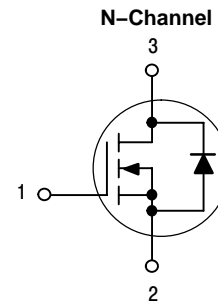

#### MARKING DIAGRAM AND PIN ASSIGNMENT

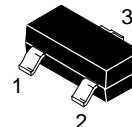

SOT-23  
CASE 318  
STYLE 21

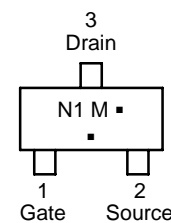

- N1 = Specific Device Code
- M = Date Code\*
- = Pb-Free Package

(Note: Microdot may be in either location)

\*Date Code orientation and/or overbar may vary depending upon manufacturing location.

#### ORDERING INFORMATION

| Device        | Package             | Shipping†        |
|---------------|---------------------|------------------|
| MMBF0201NLT1  | SOT-23              | 3000 Tape & Reel |
| MMBF0201NLT1G | SOT-23<br>(Pb-Free) | 3000 Tape & Reel |

†For information on tape and reel specifications, including part orientation and tape sizes, please refer to our Tape and Reel Packaging Specifications Brochure, BRD8011/D.

Preferred devices are recommended choices for future use and best overall value.

# MMBF0201NLT1

## ELECTRICAL CHARACTERISTICS ( $T_A = 25^\circ\text{C}$ unless otherwise noted)

| Characteristic | Symbol | Min | Typ | Max | Unit |
|----------------|--------|-----|-----|-----|------|
|----------------|--------|-----|-----|-----|------|

### OFF CHARACTERISTICS

|   |               |    |   |           |                  |
|---|---------------|----|---|-----------|------------------|
| Drain-to-Source Breakdown Voltage<br>( $V_{GS} = 0\text{ Vdc}$ , $I_D = 10\ \mu\text{A}$ )  | $V_{(BR)DSS}$ | 20 | – | –         | Vdc              |
| Zero Gate Voltage Drain Current<br>( $V_{DS} = 16\text{ Vdc}$ , $V_{GS} = 0\text{ Vdc}$ )<br>( $V_{DS} = 16\text{ Vdc}$ , $V_{GS} = 0\text{ Vdc}$ , $T_J = 125^\circ\text{C}$ ) | $I_{DSS}$     | –  | – | 1.0<br>10 | $\mu\text{A}$ dc |
| Gate-Body Leakage Current ( $V_{GS} = \pm 20\text{ Vdc}$ , $V_{DS} = 0$ )   | $I_{GSS}$     | –  | – | $\pm 100$ | nA               |

### ON CHARACTERISTICS (Note 1)

|   |              |     |             |            |          |
|---|--------------|-----|-------------|------------|----------|
| Gate Threshold Voltage<br>( $V_{DS} = V_{GS}$ , $I_D = 250\ \mu\text{A}$ )  | $V_{GS(th)}$ | 1.0 | 1.7         | 2.4        | Vdc      |
| Static Drain-to-Source On-Resistance<br>( $V_{GS} = 10\text{ Vdc}$ , $I_D = 300\text{ mA}$ dc)<br>( $V_{GS} = 4.5\text{ Vdc}$ , $I_D = 100\text{ mA}$ dc) | $r_{DS(on)}$ | –   | 0.75<br>1.0 | 1.0<br>1.4 | $\Omega$ |
| Forward Transconductance ( $V_{DS} = 10\text{ Vdc}$ , $I_D = 200\text{ mA}$ dc)   | $g_{FS}$     | –   | 450         | –          | mMhos    |

### DYNAMIC CHARACTERISTICS

|                      |                             |           |   |     |   |    |
|----------------------|-----------------------------|-----------|---|-----|---|----|
| Input Capacitance    | ( $V_{DS} = 5.0\text{ V}$ ) | $C_{iss}$ | – | 45  | – | pF |
| Output Capacitance   | ( $V_{DS} = 5.0\text{ V}$ ) | $C_{oss}$ | – | 25  | – |    |
| Transfer Capacitance | ( $V_{DG} = 5.0\text{ V}$ ) | $C_{rss}$ | – | 5.0 | – |    |

### SWITCHING CHARACTERISTICS (Note 2)

|                            |  |              |   |      |   |    |
|----------------------------|--|--------------|---|------|---|----|
| Turn-On Delay Time         | (V <sub>DD</sub> = 15 Vdc, I <sub>D</sub> = 300 mA, R <sub>L</sub> = 50 $\Omega$ ) | $t_{d(on)}$  | – | 2.5  | – | ns |
| Rise Time                  |  | $t_r$        | – | 2.5  | – |    |
| Turn-Off Delay Time        |  | $t_{d(off)}$ | – | 15   | – |    |
| Fall Time                  |  | $t_f$        | – | 0.8  | – |    |
| Gate Charge (See Figure 5) |  | $Q_T$        | – | 1400 | – | pC |

### SOURCE-DRAIN DIODE CHARACTERISTICS

|                          |          |   |      |      |   |
|--------------------------|----------|---|------|------|---|
| Continuous Current       | $I_S$    | – | –    | 0.3  | A |
| Pulsed Current           | $I_{SM}$ | – | –    | 0.75 |   |
| Forward Voltage (Note 2) | $V_{SD}$ | – | 0.85 | –    | V |

1. Pulse Test: Pulse Width  $\leq 300\ \mu\text{s}$ , Duty Cycle  $\leq 2\%$ .
2. Switching characteristics are independent of operating junction temperature.

TYPICAL ELECTRICAL CHARACTERISTICS

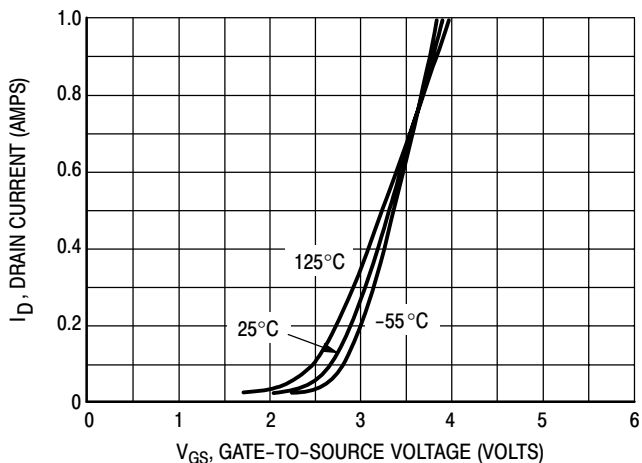

Figure 1. Transfer Characteristics

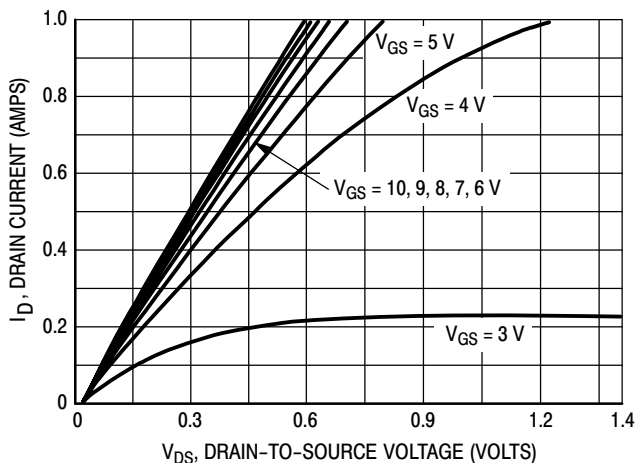

Figure 2. On-Region Characteristics

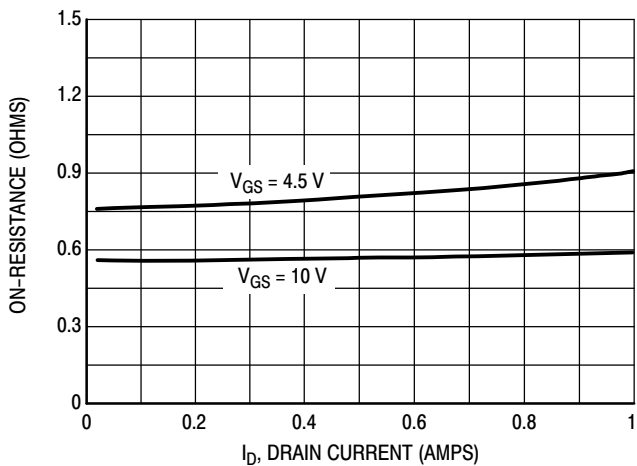

Figure 3. On-Resistance versus Drain Current

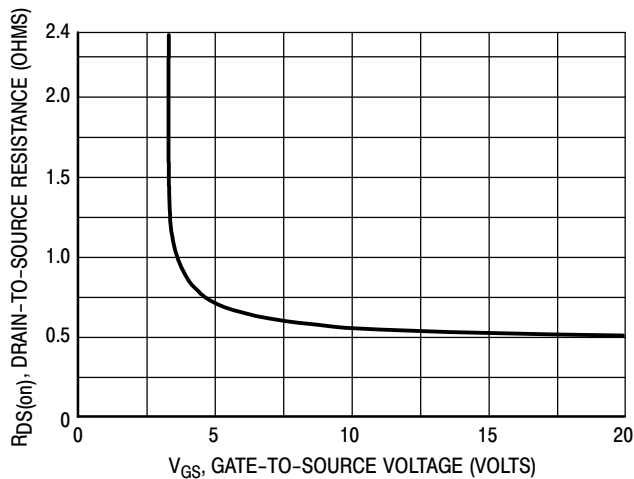

Figure 4. On-Resistance versus Gate-to-Source Voltage

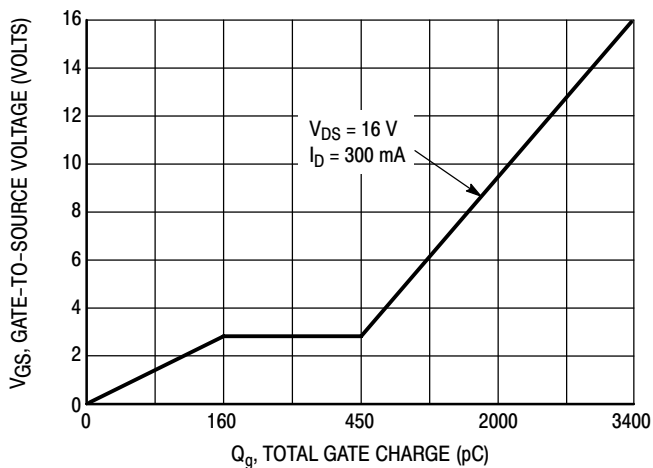

Figure 5. Gate Charge

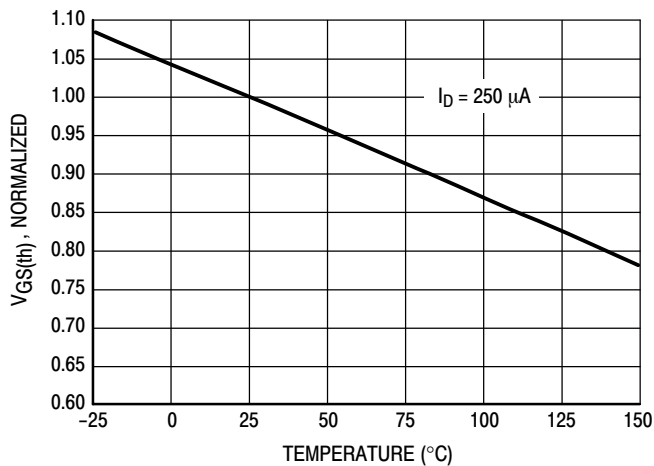

Figure 6. Threshold Voltage Variance Over Temperature

TYPICAL ELECTRICAL CHARACTERISTICS

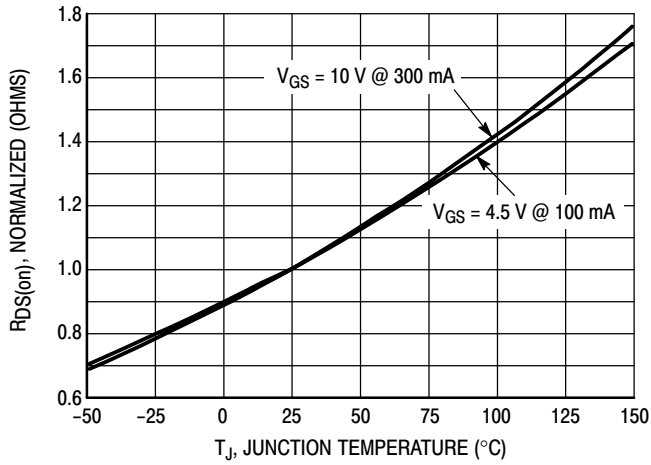

Figure 7. On-Resistance versus Junction Temperature

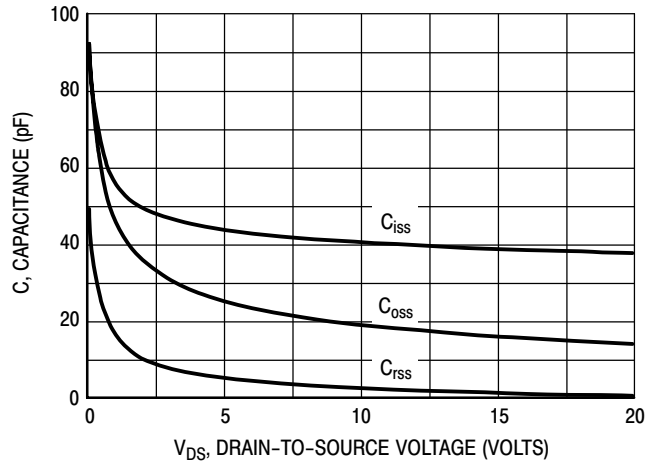

Figure 8. Capacitance

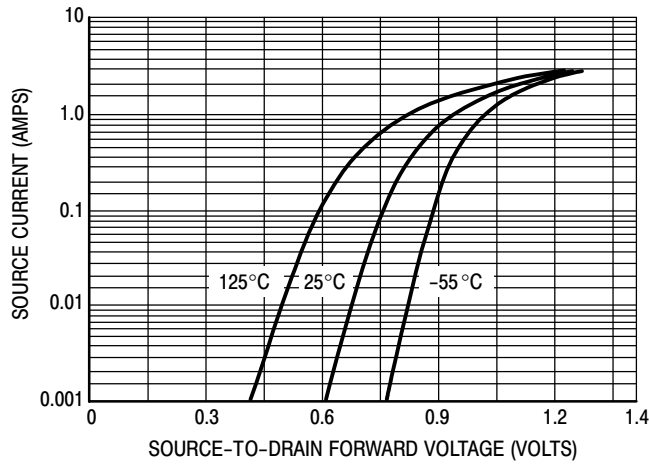
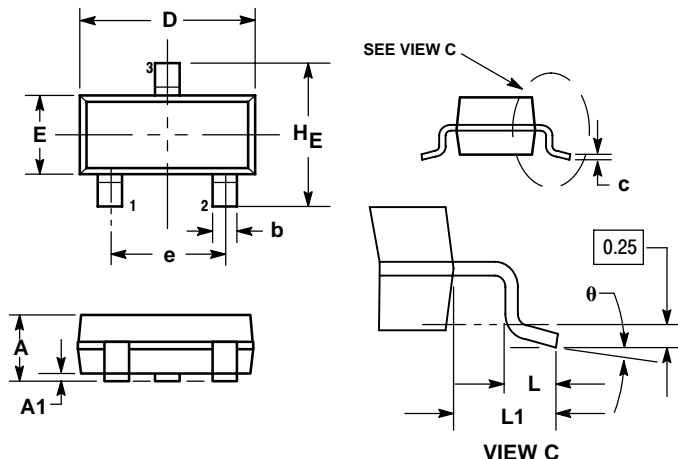

Figure 9. Source-to-Drain Forward Voltage versus Continuous Current ( $I_S$ )

# MMBF0201NLT1

## PACKAGE DIMENSIONS

SOT-23 (TO-236)  
CASE 318-08  
ISSUE AN



- NOTES:
1. DIMENSIONING AND TOLERANCING PER ANSI Y14.5M, 1982.
  2. CONTROLLING DIMENSION: INCH.
  3. MAXIMUM LEAD THICKNESS INCLUDES LEAD FINISH THICKNESS. MINIMUM LEAD THICKNESS IS THE MINIMUM THICKNESS OF BASE MATERIAL.
  4. 318-01 THRU -07 AND -09 OBSOLETE, NEW STANDARD 318-08.

| DIM | MILLIMETERS |      |      | INCHES |       |       |
|-----|-------------|------|------|--------|-------|-------|
|     | MIN         | NOM  | MAX  | MIN    | NOM   | MAX   |
| A   | 0.89        | 1.00 | 1.11 | 0.035  | 0.040 | 0.044 |
| A1  | 0.01        | 0.06 | 0.10 | 0.001  | 0.002 | 0.004 |
| b   | 0.37        | 0.44 | 0.50 | 0.015  | 0.018 | 0.020 |
| c   | 0.09        | 0.13 | 0.18 | 0.003  | 0.005 | 0.007 |
| D   | 2.80        | 2.90 | 3.04 | 0.110  | 0.114 | 0.120 |
| E   | 1.20        | 1.30 | 1.40 | 0.047  | 0.051 | 0.055 |
| e   | 1.78        | 1.90 | 2.04 | 0.070  | 0.075 | 0.081 |
| L   | 0.10        | 0.20 | 0.30 | 0.004  | 0.008 | 0.012 |
| L1  | 0.35        | 0.54 | 0.69 | 0.014  | 0.021 | 0.029 |
| HE  | 2.10        | 2.40 | 2.64 | 0.083  | 0.094 | 0.104 |

- STYLE 21:  
PIN 1. GATE  
2. SOURCE  
3. DRAIN

### SOLDERING FOOTPRINT\*

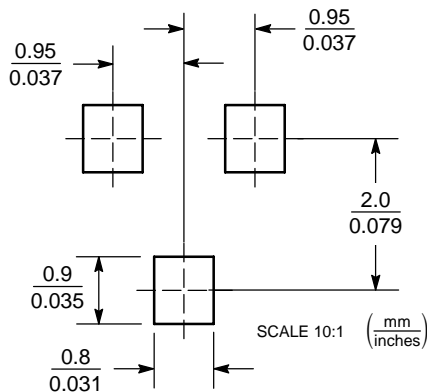

\*For additional information on our Pb-Free strategy and soldering details, please download the ON Semiconductor Soldering and Mounting Techniques Reference Manual, SOLDERRM/D.

ON Semiconductor and are registered trademarks of Semiconductor Components Industries, LLC (SCILLC). SCILLC reserves the right to make changes without further notice to any products herein. SCILLC makes no warranty, representation or guarantee regarding the suitability of its products for any particular purpose, nor does SCILLC assume any liability arising out of the application or use of any product or circuit, and specifically disclaims any and all liability, including without limitation special, consequential or incidental damages. "Typical" parameters which may be provided in SCILLC data sheets and/or specifications can and do vary in different applications and actual performance may vary over time. All operating parameters, including "Typicals" must be validated for each customer application by customer's technical experts. SCILLC does not convey any license under its patent rights nor the rights of others. SCILLC products are not designed, intended, or authorized for use as components in systems intended for surgical implant into the body, or other applications intended to support or sustain life, or for any other application in which the failure of the SCILLC product could create a situation where personal injury or death may occur. Should Buyer purchase or use SCILLC products for any such unintended or unauthorized application, Buyer shall indemnify and hold SCILLC and its officers, employees, subsidiaries, affiliates, and distributors harmless against all claims, costs, damages, and expenses, and reasonable attorney fees arising out of, directly or indirectly, any claim of personal injury or death associated with such unintended or unauthorized use, even if such claim alleges that SCILLC was negligent regarding the design or manufacture of the part. SCILLC is an Equal Opportunity/Affirmative Action Employer. This literature is subject to all applicable copyright laws and is not for resale in any manner.

### PUBLICATION ORDERING INFORMATION

**LITERATURE FULFILLMENT:**  
Literature Distribution Center for ON Semiconductor  
P.O. Box 61312, Phoenix, Arizona 85082-1312 USA  
**Phone:** 480-829-7710 or 800-344-3860 Toll Free USA/Canada  
**Fax:** 480-829-7709 or 800-344-3867 Toll Free USA/Canada  
**Email:** orderlit@onsemi.com

**N. American Technical Support:** 800-282-9855 Toll Free  
USA/Canada

**Japan:** ON Semiconductor, Japan Customer Focus Center  
2-9-1 Kamimeguro, Meguro-ku, Tokyo, Japan 153-0051  
**Phone:** 81-3-5773-3850

**ON Semiconductor Website:** <http://onsemi.com>

**Order Literature:** <http://www.onsemi.com/litorder>

For additional information, please contact your local Sales Representative.