

RXE Selection Guide and Product Data



This section has two parts:

- **A Selection Guide that walks you through the process of selecting the correct RXE device for a circuit.**
- **Product Data that outlines electrical characteristics, physical characteristics, agency recognitions, environmental specifications, component layouts, tape and reel specifications, and ordering information for RXE devices.**

RXE Selection Guide

Follow these seven steps to select a PolySwitch RXE device for a circuit:

1. Define the operating parameters for the circuit.
These include:
 - Maximum ambient operating temperature
 - Normal operating current
 - Maximum operating voltage (RXE is 60 V maximum)
 - Maximum interrupt current
2. Select the RXE device that accommodates the circuit's maximum ambient operating temperature and normal operating current.
3. Compare the RXE device's maximum operating voltage and maximum interrupt current with the circuit's to be sure the circuit does not exceed the device ratings.
4. Check the RXE device's time-to-trip to be sure it will protect the circuit.
5. Verify that the circuit's ambient operating temperatures are within the RXE device's operating temperature range.
6. Verify that the RXE device's dimensions fit the application's space considerations.
7. Independently evaluate and test the suitability and performance of the RXE device in the application.

4



1. Define the circuit's operating parameters.

Fill in the following information about the circuit:

Maximum ambient operating temperature _____

Normal operating current _____

Maximum operating voltage (RXE is 60 V max.) _____

Maximum interrupt current _____

2. Select the PolySwitch RXE device that will accommodate the circuit's maximum ambient operating temperature and normal operating current.

Look across the top of the table on the next page to find the temperature that most closely matches the circuit's maximum ambient operating temperature. Look down that column to find the value equal to or greater than the circuit's normal operating current. Now look to the far left of that row to find the part number for the RXE device that will best accommodate the circuit.

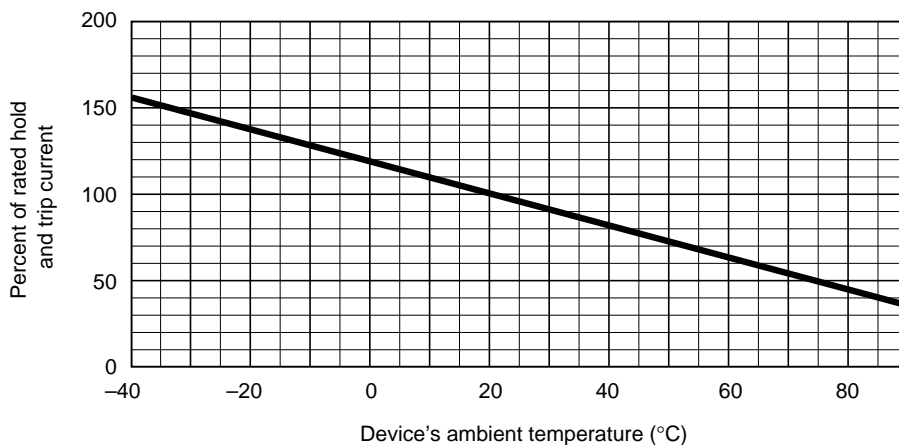
The thermal derating curve located on the next page is a normalized representation of the data in the table located on the same page.

I_{Hold} vs. temperature

Part number	Maximum ambient operating temperatures (°C)								
	-40°	-20°	0°	20°	40°	50°	60°	70°	85°
RXE010	0.16	0.14	0.12	0.10	0.08	0.07	0.06	0.05	0.04
RXE017	0.26	0.23	0.20	0.17	0.14	0.12	0.11	0.09	0.07
RXE020	0.31	0.27	0.24	0.20	0.16	0.14	0.13	0.11	0.08
RXE025	0.39	0.34	0.30	0.25	0.20	0.18	0.16	0.14	0.10
RXE030	0.47	0.41	0.36	0.30	0.24	0.22	0.19	0.16	0.12
RXE040	0.62	0.54	0.48	0.40	0.32	0.29	0.25	0.22	0.16
RXE050	0.78	0.68	0.60	0.50	0.41	0.36	0.32	0.27	0.20
RXE065	1.01	0.88	0.77	0.65	0.53	0.47	0.41	0.35	0.26
RXE075	1.16	1.02	0.89	0.75	0.61	0.54	0.47	0.41	0.30
RXE090	1.40	1.22	1.07	0.90	0.73	0.65	0.57	0.49	0.36
RXE110	1.71	1.50	1.31	1.10	0.89	0.79	0.69	0.59	0.44
RXE135	2.09	1.84	1.61	1.35	1.09	0.97	0.85	0.73	0.54
RXE160	2.48	2.18	1.90	1.60	1.30	1.15	1.01	0.86	0.64
RXE185	2.87	2.52	2.20	1.85	1.50	1.33	1.17	1.00	0.74
RXE250	3.88	3.40	2.98	2.50	2.03	1.80	1.58	1.35	1.00
RXE300	4.65	4.08	3.57	3.00	2.43	2.16	1.89	1.62	1.20
RXE375	5.81	5.10	4.46	3.75	3.04	2.70	2.36	2.03	1.50



Thermal derating curve



3. Compare maximum operating voltages and maximum interrupt currents.

Look down the first column of the table below to find the part number you selected in Step 1. Look to the right in that row to find the device's maximum operating voltage (V max.) and maximum interrupt current (I max.).

Compare both ratings with the circuit's to be sure the circuit's ratings do not exceed those of the RXE device.

Maximum device voltages and currents

Part number	V max. (volts)	I max.* (amps)
RXE010	60	40
RXE017	60	40
RXE020	60	40
RXE025	60	40
RXE030	60	40
RXE040	60	40
RXE050	60	40
RXE065	60	40
RXE075	60	40
RXE090	60	40
RXE110	60	40
RXE135	60	40
RXE160	60	40
RXE185	60	40
RXE250	60	40
RXE300	60	40
RXE375	60	40

* Devices may withstand higher interrupt current at lower voltages. Each application will need to be individually qualified.



4. Determine time-to-trip.

Time-to-trip is the amount of time it takes for a device to switch to a high-resistance state once a fault current has been applied across the device.

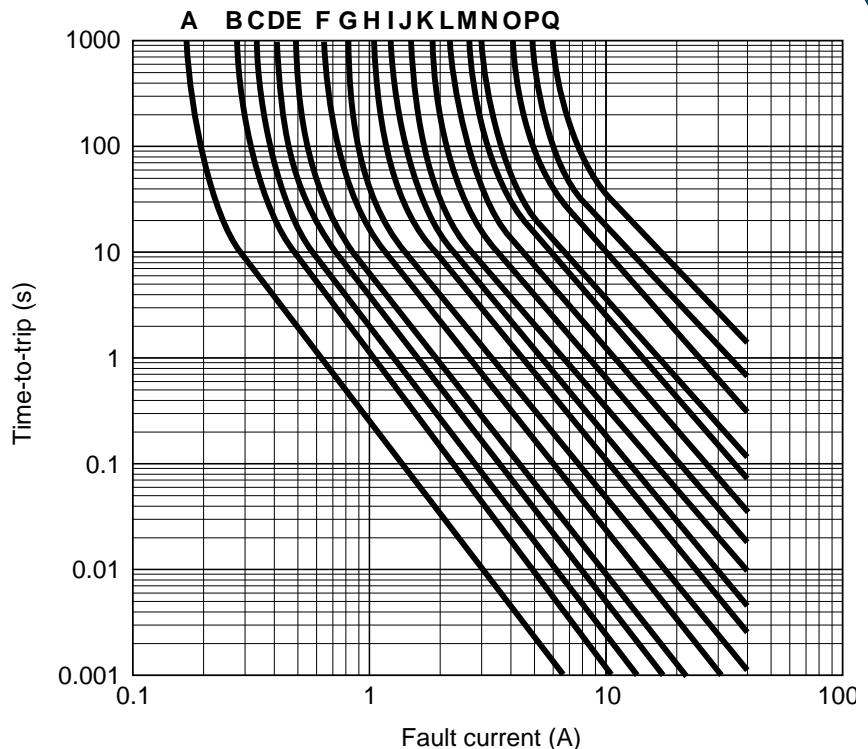
Identifying the RXE device's time-to-trip is important in order to provide the desired protection capabilities. If the device you choose trips too fast, undesired or nuisance tripping will occur. If the device trips too slowly, the components being protected may be damaged before the device switches to a high-resistance state.

The chart below shows the typical time-to-trip at 20°C for each PolySwitch RXE device. For example, the chart indicates that the typical time-to-trip for RXE050 at 5 A is 0.3 second.

On the chart below, find the typical time-to-trip for the RXE device you selected. If the RXE device's time-to-trip is too fast or too slow for the circuit, go back to Step 2 and choose an alternate device.

Typical time-to-trip at 20°C

- A** = RXE010
- B** = RXE017
- C** = RXE020
- D** = RXE025
- E** = RXE030
- F** = RXE040
- G** = RXE050
- H** = RXE065
- I** = RXE075
- J** = RXE090
- K** = RXE110
- L** = RXE135
- M** = RXE160
- N** = RXE185
- O** = RXE250
- P** = RXE300
- Q** = RXE375



5. Verify ambient operating conditions.

Ensure that your application's minimum and maximum ambient temperatures are within the operating temperature range of -40°C and 85°C .

Maximum device surface temperature in the tripped state is 125°C .

6. Verify the RXE device's dimensions.

Using dimensions from the table below, compare the dimensions of the RXE device you selected with the application's space considerations.

Product dimensions (millimeters/inches)

Part number	A max.	B max.	C typ.	D min.	E max.	F typ.
RXE010	7.4 (0.29)	12.7 (0.50)	5.1 (0.20)	7.6 (0.30)	3.1 (0.12)	1.1 (0.04)
RXE017	7.4 (0.29)	12.7 (0.50)	5.1 (0.20)	7.6 (0.30)	3.1 (0.12)	1.6 (0.06)
RXE020	7.4 (0.29)	12.2 (0.48)	5.1 (0.20)	7.6 (0.30)	3.1 (0.12)	1.1 (0.04)
RXE025	7.4 (0.29)	12.7 (0.50)	5.1 (0.20)	7.6 (0.30)	3.1 (0.12)	1.1 (0.04)
RXE030	7.4 (0.29)	13.0 (0.51)	5.1 (0.20)	7.6 (0.30)	3.1 (0.12)	1.1 (0.04)
RXE040	7.6 (0.30)	13.5 (0.53)	5.1 (0.20)	7.6 (0.30)	3.1 (0.12)	1.1 (0.04)
RXE050	7.9 (0.31)	13.7 (0.54)	5.1 (0.20)	7.6 (0.30)	3.1 (0.12)	1.1 (0.04)
RXE065	9.7 (0.38)	14.5 (0.57)	5.1 (0.20)	7.6 (0.30)	3.1 (0.12)	1.1 (0.04)
RXE075	10.4 (0.41)	15.2 (0.60)	5.1 (0.20)	7.6 (0.30)	3.1 (0.12)	1.1 (0.04)
RXE090	11.7 (0.46)	15.8 (0.62)	5.1 (0.20)	7.6 (0.30)	3.1 (0.12)	1.1 (0.04)
RXE110	13.0 (0.51)	18.0 (0.71)	5.1 (0.20)	7.6 (0.30)	3.1 (0.12)	1.4 (0.06)
RXE135	14.5 (0.57)	19.6 (0.77)	5.1 (0.20)	7.6 (0.30)	3.1 (0.12)	1.4 (0.06)
RXE160	16.3 (0.64)	21.3 (0.84)	5.1 (0.20)	7.6 (0.30)	3.1 (0.12)	1.4 (0.06)
RXE185	17.8 (0.70)	22.9 (0.90)	5.1 (0.20)	7.6 (0.30)	3.1 (0.12)	1.4 (0.06)
RXE250	21.3 (0.84)	26.4 (1.04)	10.2 (0.40)	7.6 (0.30)	3.1 (0.12)	1.4 (0.06)
RXE300	24.9 (0.98)	30.0 (1.18)	10.2 (0.40)	7.6 (0.30)	3.1 (0.12)	1.4 (0.06)
RXE375	28.5 (1.12)	33.5 (1.32)	10.2 (0.40)	7.6 (0.30)	3.1 (0.12)	1.4 (0.06)

Lead size

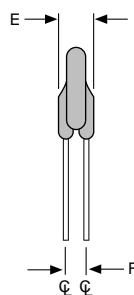
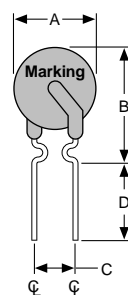
RXE010–RXE090 $\varnothing 0.51$
(0.020)
24 AWG

RXE110–RXE375 $\varnothing 0.81$
(0.032)
20 AWG

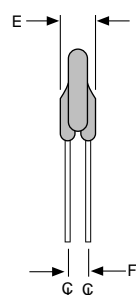
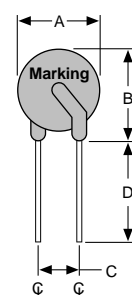
* Straight leads are available.

** Kinked leads are available.

RXE010–RXE090*



RXE110–RXE375**



RXE Product Data

Now that you have selected your RXE device, please review the device's characteristics in this section to verify that the device will perform as required.

Electrical characteristics (20°C)

Part Number	I_H (A)	I_T (A)	Max. time to trip (s) at $5 \times I_H$	P_d (W)	Initial resistance		Post-trip resistance
					R min. (Ω)	R max. (Ω)	R1 max. (Ω)
RXE010	0.10	0.20	4.0	0.38	2.50	4.50	7.50
RXE017	0.17	0.34	3.0	0.48	3.30	5.21	8.00
RXE020	0.20	0.40	2.2	0.41	1.83	2.75	4.40
RXE025	0.25	0.50	2.5	0.45	1.25	1.95	3.00
RXE030	0.30	0.60	3.0	0.49	0.88	1.33	2.10
RXE040	0.40	0.80	3.8	0.56	0.55	0.86	1.29
RXE050	0.50	1.00	4.0	0.77	0.50	0.77	1.17
RXE065	0.65	1.30	5.3	0.88	0.31	0.48	0.72
RXE075	0.75	1.50	6.3	0.92	0.25	0.40	0.60
RXE090	0.90	1.80	7.2	0.99	0.20	0.31	0.47
RXE110	1.10	2.20	8.2	1.50	0.15	0.25	0.38
RXE135	1.35	2.70	9.6	1.70	0.12	0.19	0.30
RXE160	1.60	3.20	11.4	1.90	0.09	0.14	0.22
RXE185	1.85	3.70	12.6	2.10	0.08	0.12	0.19
RXE250	2.50	5.00	15.6	2.50	0.05	0.08	0.13
RXE300	3.00	6.00	19.8	2.80	0.04	0.06	0.10
RXE375	3.75	7.50	24.0	3.20	0.03	0.05	0.08

I_H = Hold current—maximum current at which the device will not trip at 20°C.

I_T = Trip current—minimum current at which the device will always trip at 20°C.

P_d = Typical power dissipation—typical amount of power dissipated by the device when in tripped state in 20°C still air.

R min. = Minimum device resistance at 20°C prior to tripping.

R max. = Maximum device resistance at 20°C prior to tripping.

R1 max. = Maximum device resistance at 20°C measured 1 hour post trip.

Physical characteristics

Lead material	RXE010: Tin coated nickel-copper alloy, 24 AWG, \varnothing 0.51 mm/0.020 in RXE017–040: Tin/lead-plated copper-clad steel, 24 AWG, \varnothing 0.51 mm/0.020 in RXE050–090: Tin/lead-plated copper, 24 AWG, \varnothing 0.51 mm/0.020 in RXE110–375: Tin-plated copper, 20 AWG, \varnothing 0.81 mm/0.032 in
Soldering characteristics	Solderability per MIL-STD-202, Method 208E Solder heat withstand per MIL-STD-202, Method 210, Condition B
Insulating material	Cured, flame-retardant epoxy polymer; meets UL 94V-O requirements

Note: Devices are not designed to be placed through a reflow process.



Agency recognitions

UL	File # E74889
CSA	File # CA78165C
TÜV	Certificate # R9477354

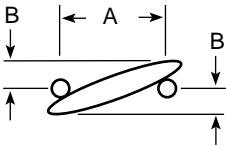
Environmental specifications

Test	Test method	Conditions	Resistance change
Passive aging	Raychem PS300	70°C, 1000 hours	±5%
		85°C, 1000 hours	±5%
Humidity aging	Raychem PS300	85°C, 85% R.H., 1000 hours	±5%
Thermal shock	Raychem PS300	125°C, -55°C (10 times)	±5%
Solvent resistance	Raychem PS300, Method 215	MIL-STD-202, Method 215F	No change

Component layouts

The dimensions in the table below provide the component layout for each RXE device.

Component layout dimensions (millimeters/inches)



Device	A nom.	B max.
RXE010	5.1 (0.20)	1.0 (0.04)
RXE017	5.1 (0.20)	1.7 (0.07)
RXE020	5.1 (0.20)	1.0 (0.04)
RXE025	5.1 (0.20)	1.0 (0.04)
RXE030	5.1 (0.20)	1.0 (0.04)
RXE040	5.1 (0.20)	1.2 (0.05)
RXE050	5.1 (0.20)	1.2 (0.05)
RXE065	5.1 (0.20)	1.5 (0.06)
RXE075	5.1 (0.20)	1.5 (0.06)
RXE090	5.1 (0.20)	1.5 (0.06)
RXE110	5.1 (0.20)	1.2 (0.05)
RXE135	5.1 (0.20)	1.2 (0.05)
RXE160	5.1 (0.20)	1.5 (0.06)
RXE185	5.1 (0.20)	1.5 (0.06)
RXE250	10.2 (0.40)	1.7 (0.07)
RXE300	10.2 (0.40)	2.0 (0.08)
RXE375	10.2 (0.40)	2.0 (0.08)

Tape and reel specifications (dimensions in millimeters)

Product availability: RXE010–RXE185

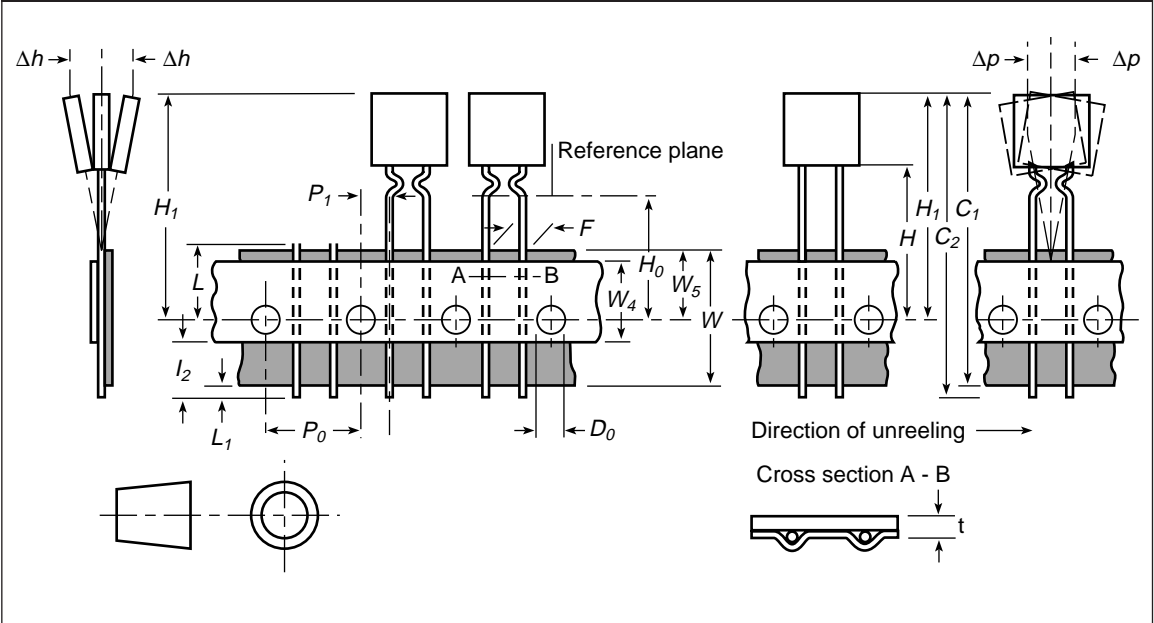
Devices taped using EIA468–B/IEC286-2 standards. See table below and Figures 1 and 2 for details.

Dimension description	EIA mark	IEC mark	Dimensions	
			Dim. (mm)	Tol. (mm)
Carrier tape width	W	W	18	–0.5/+1.0
Hold down tape width	W_4	W_0	11	min.
Top distance between tape edges	W_6	W_2	3	max.
Sprocket hole position	W_5	W_1	9	–0.5/+0.75
Sprocket hole diameter*	D_0	D_0	4	–0.32/+0.2
Abscissa to plane (straight lead)	H	H	18.5	± 3.0
Abscissa to plane (kinked lead)	H_0	H_0	16	± 0.5
Abscissa to top: RXE010-RXE090	H_1	H_1	32.2	max.
Abscissa to top: RXE110-RXE185*	H_1	H_1	37.6	max.
Overall width w/lead protrusion: RXE10-RXE90	C_1		43.2	max.
Overall width w/o lead protrusion: RXE135-RXE185*	C_2		46.6	max.
Lead protrusion	L_1	l_1	1.0	max.
Protrusion of cutout	L	L	11	max.
Protrusion beyond hold-down tape	l_2	l_2	Not specified	
Sprocket hole pitch: RXE010-RXE090	P_0	P_0	12.7	±0.3
Sprocket hole pitch*	P_0	P_0	25.5	±0.5
Pitch tolerance			20 consec.	±1
Device pitch: RXE010-RXE090			12.7	
Device pitch: RXE110-RXE185			25.4	
Tape thickness	t	t	0.9	max.
Tape thickness with splice	t_1		2.0	max.
Splice sprocket hole alignment			0	±0.3
Body lateral deviation	Δh	Δh	0	±1.0
Body tape plane deviation	Δp	Δp	0	±1.3
Ordinate to adjacent component lead*	P_1	P_1	3.81	±1.0
Lead spacing*	F	F	5.08	±0.8
Reel width: RXE090-RXE135*	w_2	w	56	max.
Reel width: RXE160-RXE185*	w_2	w	63.5	max.
Reel diameter	a	d	370	max.
Space between flanges less device*	w_1		4.75	–3.25/+9.25
Arbor hole diameter	c	f	26	±12.0
Core diameter*	n	h	91	max.
Box			56/372/372	max.
Consecutive missing places			None	
Empty places per reel			0.1% max.	

* Differs from EIA specification.

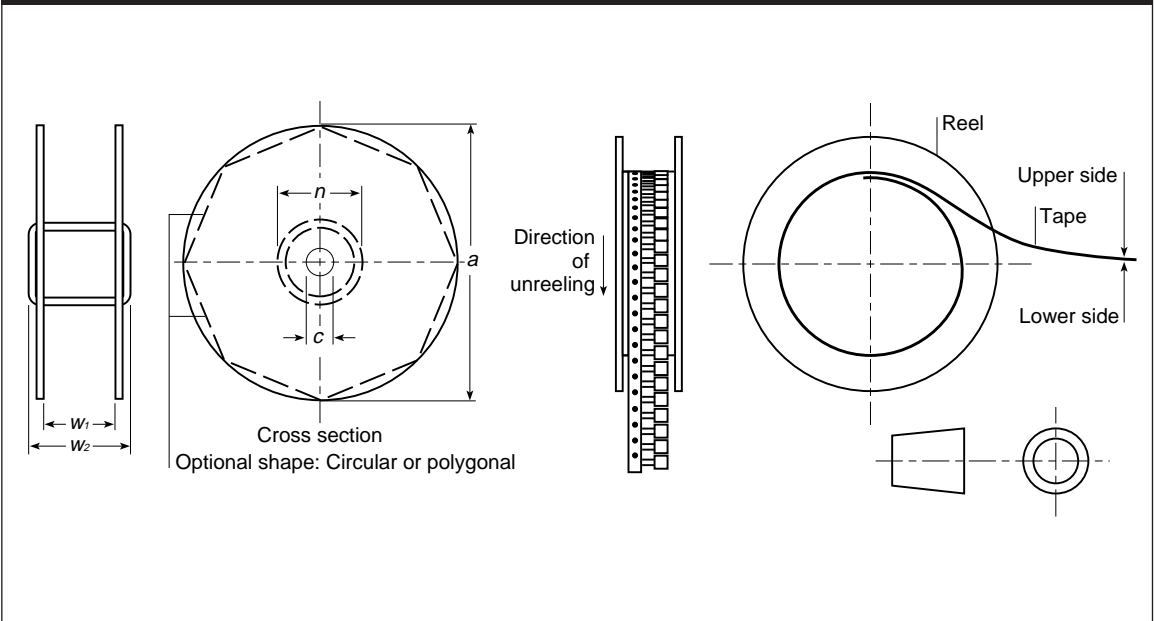


Figure 1: EIA Referenced Taped Component Dimensions



4

Figure 2: Reel Dimensions



Ordering information

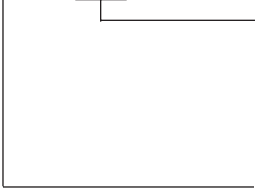
Product description	Bag quantity	Tape and reel quantity	AMMO pack	Standard package
RXE010	500			10000
RXE010-2		3000		15000
RXE010-AP			2000	10000
RXE017	500			10000
RXE017-2		2500		12500
RXE017-AP			1500	7500
RXE020	500			10000
RXE020-2		3000		15000
RXE020-AP			2000	10000
RXE025	500			10000
RXE025-2		3000		15000
RXE025-AP			2000	10000
RXE030	500			10000
RXE030-2		3000		15000
RXE030-AP			2000	10000
RXE040	500			10000
RXE040-2		3000		15000
RXE040-AP			2000	10000
RXE050	500			10000
RXE050-2		3000		15000
RXE050-AP			2000	10000
RXE065	500			10000
RXE065-2		3000		15000
RXE065-AP			2000	10000
RXE075	500			10000
RXE075-2		3000		15000
RXE075-AP			2000	10000
RXE090	500			10000
RXE090-2		3000		15000
RXE090-AP			2000	10000
RXE110	500			10000
RXE110-2		1500		7500
RXE110-AP			1000	5000
RXE135	500			10000
RXE135-2		1500		7500
RXE135-AP			1000	5000
RXE160	500			10000
RXE160-2		1500		7500
RXE160-AP			1000	5000
RXE185	500			10000
RXE185-2		1500		7500
RXE185-AP			1000	5000
RXE250	500	*	*	10000
RXE300	500	*	*	10000
RXE375	500	*	*	10000

* Consult factory



Part numbering system

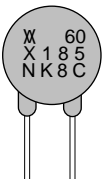
RXE suffix



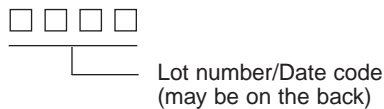
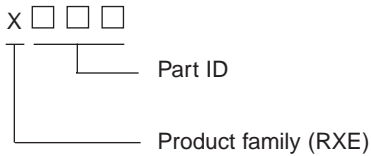
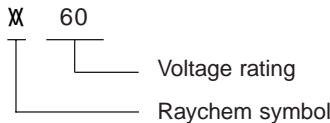
- Blank = Bulk packaged
- 2 = Tape and reel
- AP = AMMO pack
- 1 = 25.4-mm (1.0 inch) minimum lead length
- K = Kinked leads
- S = Straight leads

Current rating

Part marking system



Example



Part description	Part ID
RXE010	010
RXE017	017
RXE020	020
RXE025	025
RXE030	030
RXE040	040
RXE050	050
RXE065	065
RXE075	075
RXE090	090
RXE110	110
RXE135	135
RXE160	160
RXE185	185
RXE250	250
RXE300	300
RXE375	375

WARNING:

- Operation beyond maximum ratings or improper use may result in device damage and possible electrical arcing and flame.
- These devices are intended for protection against occasional over-current or overtemperature fault conditions, and should not be used when repeated fault conditions are anticipated.