

5 mm (T1 3/4) LED, Diffused Super-Bright, Hyper-Red GaAIAs-LED

LH 5464

Besondere Merkmale

- eingefärbtes, diffuses Gehäuse
- Doppel-Heterostruktur in GaAIAs Technologie
- besonders hohe Lichtstärke
- Lötspieße ohne Aufsetzebene
- gegurtet lieferbar
- Störimpulsfest nach DIN 40839

Features

- colored, diffused package
- double heterojunction in GaAIAs technology
- especially high luminous intensity
- solder leads without stand-off
- available taped on reel
- load dump resistant acc. to DIN 40839

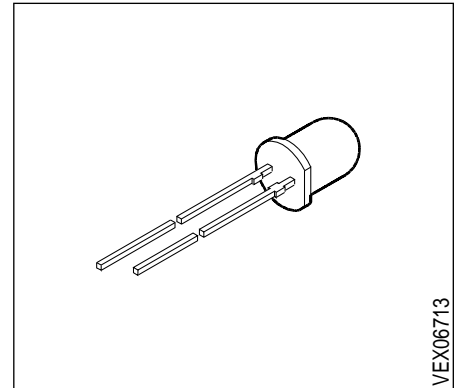

Typ Type	Emissionsfarbe Color of Emission	Gehäusefarbe Color of Package	Lichtstärke Luminous Intensity $I_F = 10 \text{ mA}$ $I_V \text{ (mcd)}$	Bestellnummer Ordering Code
LH 5464-MQ	hyper-red	red diffused	10 ... 125	Q62703-Q3829
LH 5464-N			25 ... 50	Q62703-Q3830
LH 5464-P			40 ... 80	Q62703-Q2753
LH 5464-Q			63 ... 125	Q62703-Q3831
LH 5464-NR			25 ... 200	Q62703-Q3832

Streuung der Lichtstärke in einer Verpackungseinheit $I_{V \max} / I_{V \min} \leq 2.0$.
Luminous intensity ratio in one packaging unit $I_{V \max} / I_{V \min} \leq 2.0$.

Grenzwerte
Maximum Ratings

Bezeichnung Parameter	Symbol Symbol	Werte Values	Einheit Unit
Betriebstemperatur Operating temperature range	T_{op}	- 55 ... + 100	°C
Lagertemperatur Storage temperature range	T_{stg}	- 55 ... + 100	°C
Sperrschichttemperatur Junction temperature	T_j	+ 100	°C
Durchlaßstrom Forward current	I_F	40	mA
Stoßstrom Surge current $t \leq 10 \mu\text{s}$, $D = 0.005$	I_{FM}	0.5	A
Sperrspannung Reverse voltage	V_R	3	V
Verlustleistung Power dissipation $T_A \leq 25 \text{ °C}$	P_{tot}	120	mW
Wärmewiderstand Thermal resistance Sperrschicht / Luft Junction / air	$R_{th JA}$	400	K/W

Kennwerte ($T_A = 25\text{ °C}$)

Characteristics

Bezeichnung Parameter		Symbol Symbol	Werte Values	Einheit Unit
Wellenlänge des emittierten Lichtes Wavelength at peak emission $I_F = 20\text{ mA}$	(typ.) (typ.)	λ_{peak}	660	nm
Dominantwellenlänge Dominant wavelength $I_F = 20\text{ mA}$	(typ.) (typ.)	λ_{dom}	645	nm
Spektrale Bandbreite bei 50 % $I_{\text{rel max}}$ Spectral bandwidth at 50 % $I_{\text{rel max}}$ $I_F = 20\text{ mA}$	(typ.) (typ.)	$\Delta\lambda$	22	nm
Abstrahlwinkel bei 50 % I_V (Vollwinkel) Viewing angle at 50 % I_V		2ϕ	35	Grad deg.
Durchlaßspannung Forward voltage $I_F = 10\text{ mA}$	(typ.) (max.)	V_F V_F	1.75 2.6	V V
Sperrstrom Reverse current $V_R = 3\text{ V}$	(typ.) (max.)	I_R I_R	0.01 10	μA μA
Kapazität Capacitance $V_R = 0\text{ V}, f = 1\text{ MHz}$	(typ.)	C_0	25	pF
Schaltzeiten: Switching times: I_V from 10 % to 90 % I_V from 90 % to 10 % $I_F = 100\text{ mA}, t_p = 10\text{ }\mu\text{s}, R_L = 50\text{ }\Omega$	(typ.) (typ.)	t_r t_f	140 110	ns ns

Relative spektrale Emission $I_{rel} = f(\lambda)$, $T_A = 25\text{ °C}$, $I_F = 20\text{ mA}$

Relative spectral emission

$V(\lambda)$ = spektrale Augenempfindlichkeit

Standard eye response curve

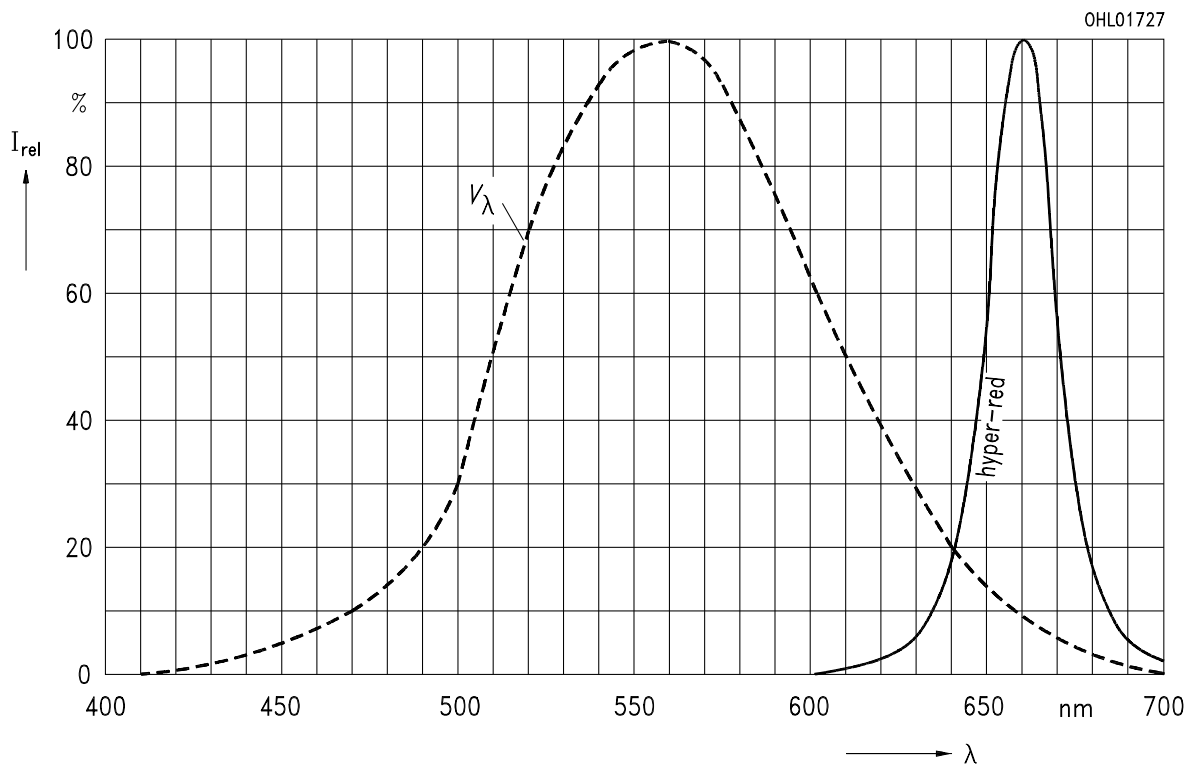

Abstrahlcharakteristik $I_{rel} = f(\varphi)$

Radiation characteristic

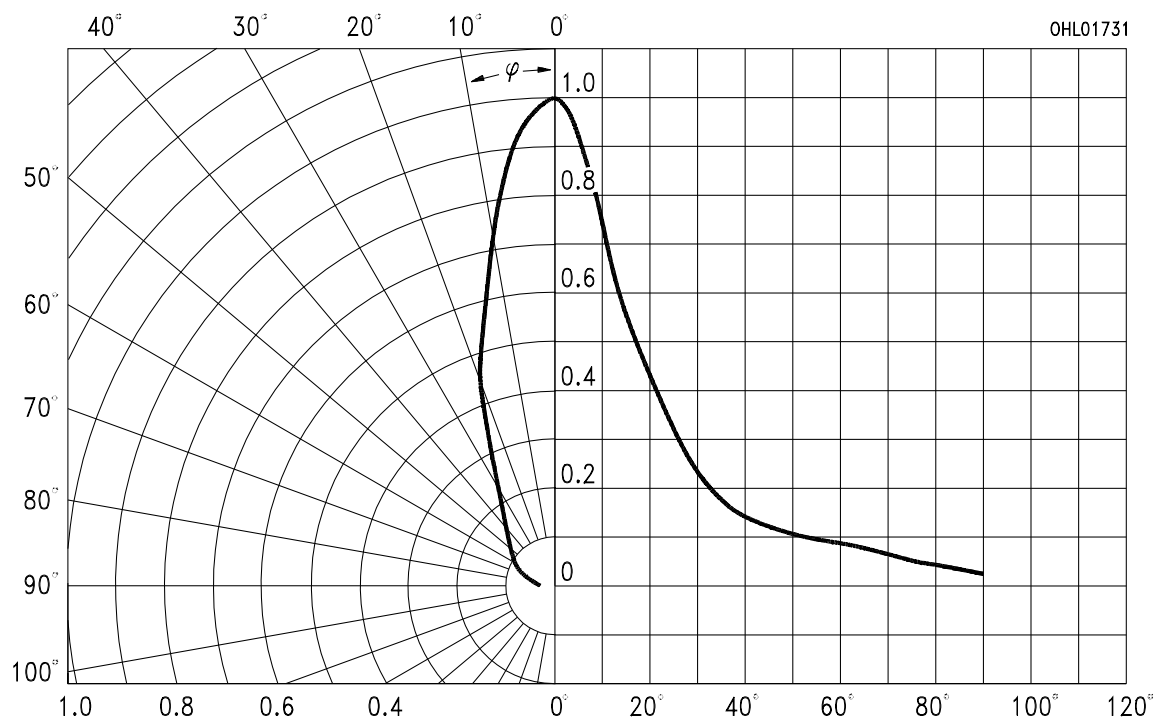

Durchlaßstrom $I_F = f(V_F)$

Forward current

$T_A = 25\text{ °C}$

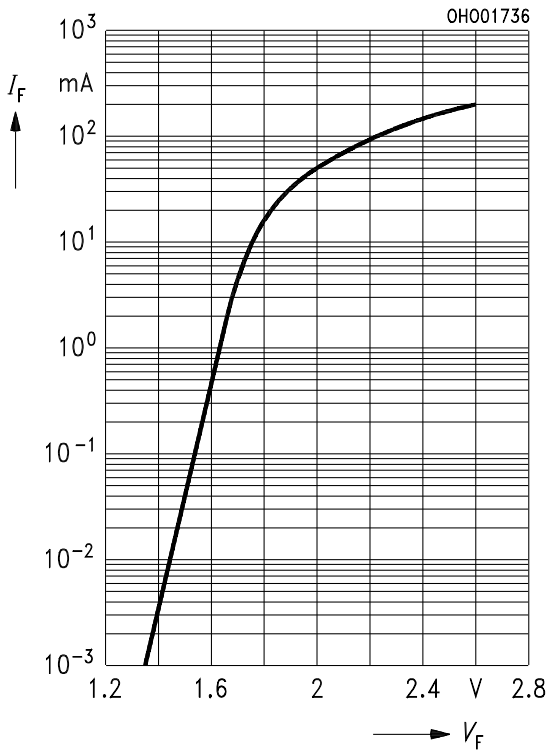

Relative Lichtstärke $I_V/I_{V(10\text{ mA})} = f(I_F)$

Relative luminous intensity

$T_A = 25\text{ °C}$

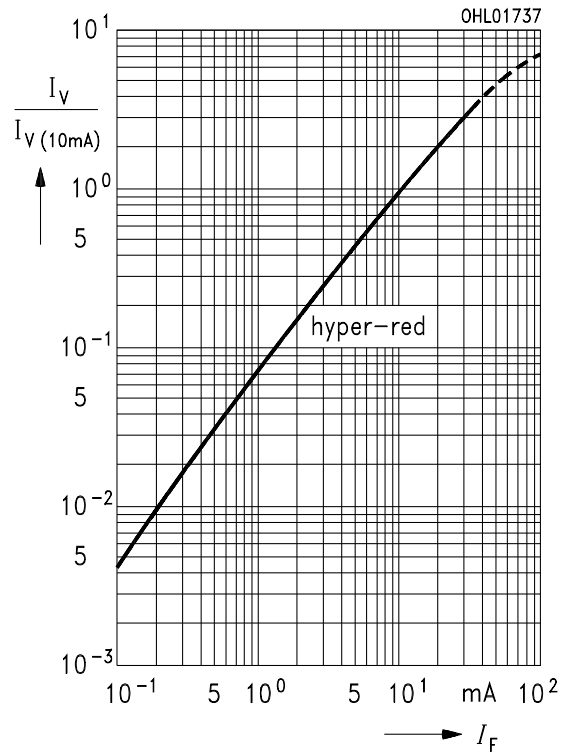

Zulässige Impulsbelastbarkeit $I_F = f(t_p)$

Permissible pulse handling capability

Duty cycle $D =$ parameter, $T_A = 25\text{ °C}$

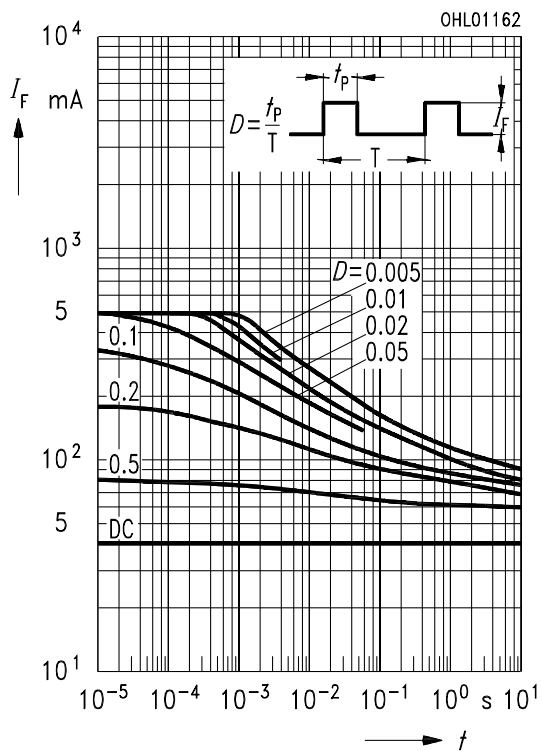

Maximal zulässiger Durchlaßstrom

Max. permissible forward current

$I_F = f(T_A)$

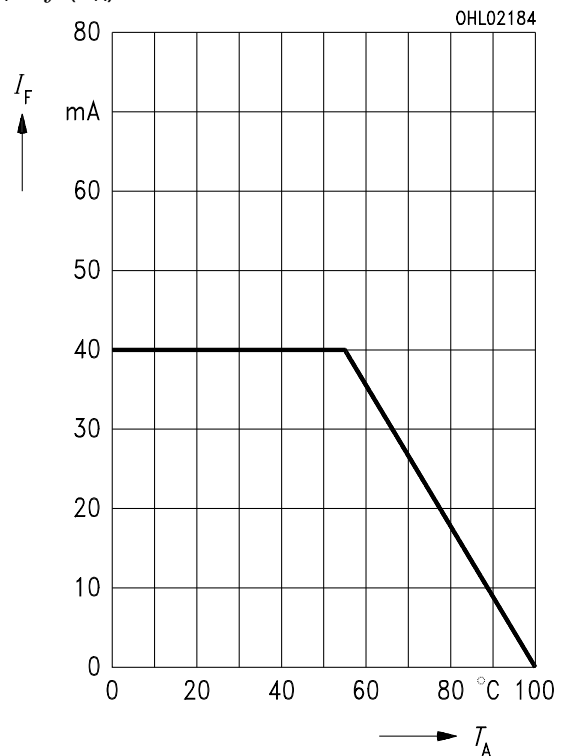

Wellenlänge der Strahlung $\lambda_{\text{peak}} = f(T_A)$
Wavelength at peak emission

$I_F = 20 \text{ mA}$

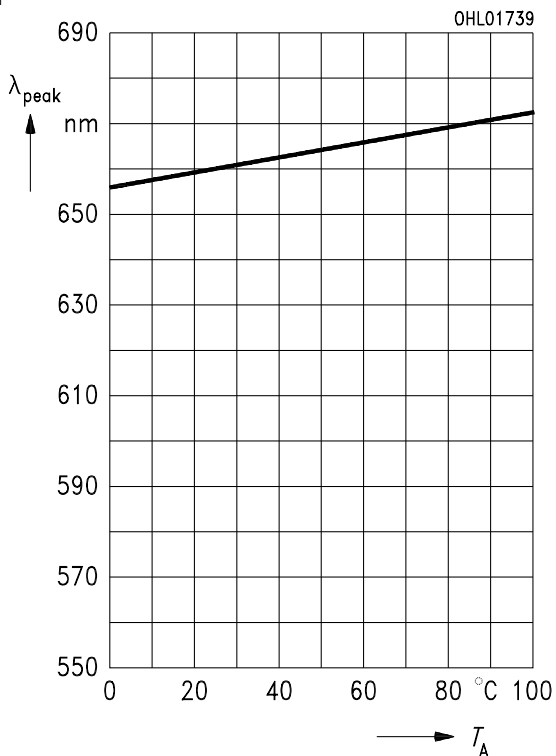

Dominantwellenlänge $\lambda_{\text{dom}} = f(T_A)$
Dominant wavelength

$I_F = 20 \text{ mA}$

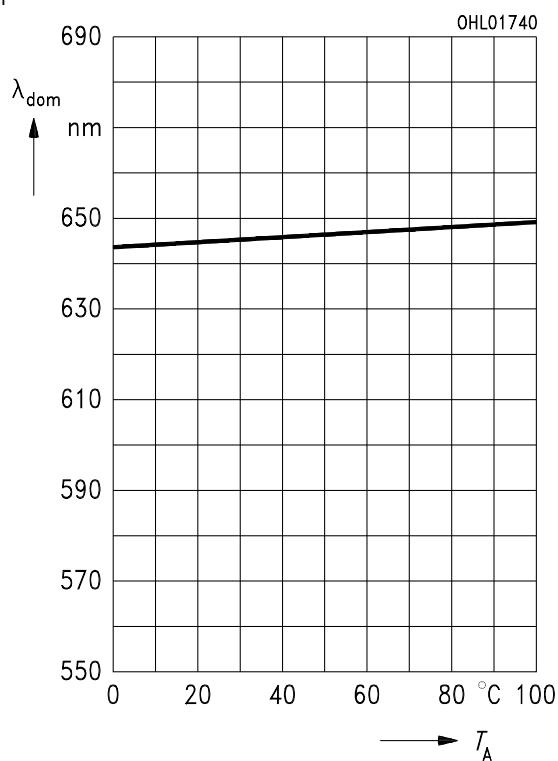

Durchlaßspannung $V_F = f(T_A)$
Forward voltage

$I_F = 10 \text{ mA}$

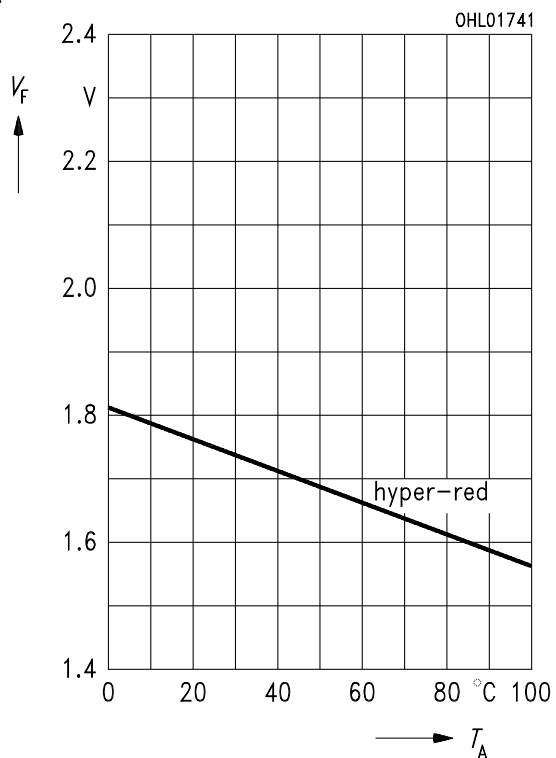

Relative Lichtstärke $I_V/I_{V(25^{\circ}\text{C})} = f(T_A)$
Relative luminous intensity

$I_F = 10 \text{ mA}$

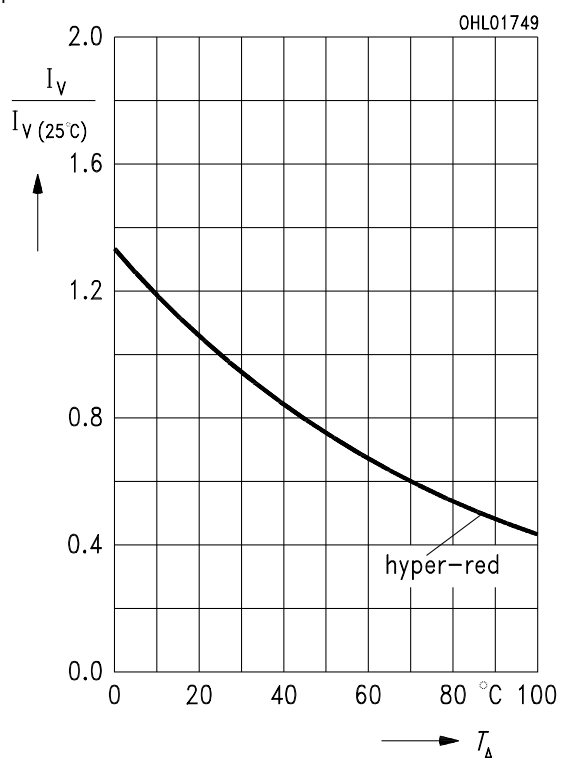

Maßzeichnung (Maße in mm, wenn nicht anders angegeben)
Package Outlines (Dimensions in mm, unless otherwise specified)

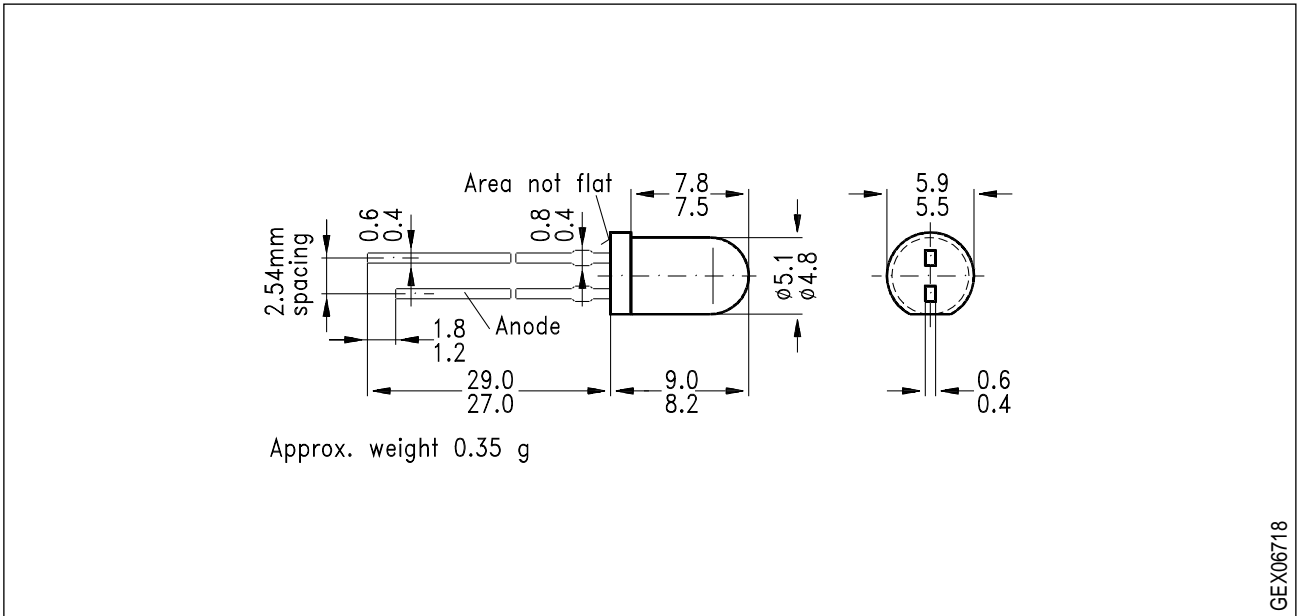

Anodenkennzeichnung: Kürzerer Lötspieß
Anode mark: Short solder lead