

## Dual 125MHz Video Current Feedback Amplifier

January 1995

### Features

- This Circuit is Processed in Accordance to MIL-STD-883 and is Fully Conformant Under the Provisions of Paragraph 1.2.1.
- Wide Unity Gain Bandwidth ..... 125MHz
- Slew Rate ..... 475V/μs
- Differential Gain ..... 0.03%
- Differential Phase ..... 0.03 Deg.
- Supply Current (per Amplifier) ..... 7.5mA
- Crosstalk Rejection at 10MHz. .... -60dB
- ESD Protection ..... 2000V
- Guaranteed Specifications at ±5V Supplies

### Applications

- Video Gain Block
- Video Distribution Amplifier/RGB Amplifier
- Flash A/D Driver
- Current to Voltage Converter
- Radar and Imaging Systems
- Medical Imaging

### Description

The HA5023/883 is a dual version of the popular Intersil HA-5020/883 except that it does not have an enable function. It features wide bandwidth and high slew rate, and is optimized for video applications and gains between 1 and 10. It is a current feedback amplifier and thus yields less bandwidth degradation at high closed loop gains than voltage feedback amplifiers.

The low differential gain and phase, 0.1dB gain flatness, and ability to drive two back terminated 75Ω cables, make this amplifier ideal for demanding video applications.

The current feedback design allows the user to take advantage of the amplifier's bandwidth dependency on the feedback resistor. By reducing  $R_F$ , the bandwidth can be increased to compensate for decreases at higher closed loop gains or heavy output loads.

### Ordering Information

PART NUMBER	TEMPERATURE RANGE	PACKAGE
HA5023MJ/883	-55°C to +125°C	8 Lead CerDIP

### Pinout

HA5023/883  
(CERDIP)  
TOP VIEW

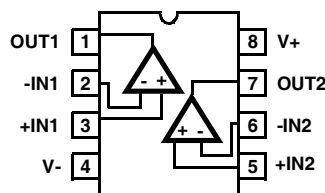

# Specifications HA5023/883

## Absolute Maximum Ratings

Voltage Between V+ and V- . . . . .	36V
Differential Input Voltage . . . . .	10V
Voltage at Either Input Terminal . . . . .	V+ to V-
Output Current . . . . .	Fully Short Circuit Protected
Junction Temperature . . . . .	+175°C
ESD Rating . . . . .	< 2000V
Storage Temperature Range . . . . .	-65°C ≤ T <sub>A</sub> ≤ +150°C
Lead Temperature (Soldering 10s) . . . . .	+300°C

## Thermal Information

Thermal Resistance	$\theta_{JA}$	$\theta_{JC}$
CerDIP Package . . . . .	115°C/W	28°C/W
Maximum Package Power Dissipation at +75°C		
CerDIP Package . . . . .	0.87W	
Package Power Dissipation Derating Factor above +75°C		
CerDIP Package . . . . .	8.7mW/°C	

*CAUTION: Stresses above those listed in "Absolute Maximum Ratings" may cause permanent damage to the device. This is a stress only rating and operation of the device at these or any other conditions above those indicated in the operational sections of this specification is not implied.*

## Operating Conditions

Operating Supply Voltage (±V <sub>S</sub> ) . . . . .	±5V to ±15V	V <sub>INCM</sub> ≤ 1/2(V+ - V-)	
Operating Temperature Range . . . . .	-55°C ≤ T <sub>A</sub> ≤ +125°C	R <sub>L</sub> ≥ 50Ω	R <sub>F</sub> = 1kΩ

**TABLE 1. DC ELECTRICAL PERFORMANCE CHARACTERISTICS**

Device Tested at: V<sub>SUPPLY</sub> = ±5V, A<sub>V</sub> = +1, R<sub>F</sub> = 1kΩ, R<sub>SOURCE</sub> = 0Ω, R<sub>L</sub> = 400Ω, V<sub>OUT</sub> = 0V, Unless Otherwise Specified.

PARAMETERS	SYMBOL	CONDITIONS	GROUP A SUBGROUPS	TEMPERATURE	LIMITS		UNITS
					MIN	MAX	
Input Offset Voltage	V <sub>IO</sub>	V <sub>CM</sub> = 0V	1	+25°C	-3	3	mV
			2, 3	+125°C, -55°C	-5	5	mV
Common Mode Rejection Ratio	CMRR	ΔV <sub>CM</sub> = ±2.5V V+ = 2.5V, V- = -7.5V V+ = 7.5V, V- = -2.5V	1	+25°C	53	-	dB
			2	+125°C	38	-	dB
		3	-55°C	38	-	dB	
Power Supply Rejection Ratio	PSRR	ΔV <sub>SUP</sub> = ±1.5V V+ = 6.5V, V- = -5V V+ = 3.5V, V- = -5V	1	+25°C	60	-	dB
			2, 3	+125°C, -55°C	55	-	dB
Delta Input Offset Voltage Between Channels	ΔV <sub>IO</sub>	V <sub>CM</sub> = 0	1	+25°C	-	3.5	mV
			2,3	+125°C, -55°C	-	3.5	mV
Non-Inverting Input (+IN) Current	I <sub>BSP</sub>	V <sub>CM</sub> = 0V	1	+25°C	-8	8	μA
			2, 3	+125°C, -55°C	-20	20	μA
+IN Current Common Mode Sensitivity	CMS <sub>IBP</sub>	ΔV <sub>CM</sub> = ±2.5V V+ = 2.5V, V- = -7.5V V+ = 7.5V, V- = -2.5V	1	+25°C	-	0.15	μA/V
			2	+125°C	-	2.0	μA/V
		3	-55°C	-	2.0	μA/V	
ΔInverting Input (-IN) Current Between Channels	ΔI <sub>BSN</sub>	V <sub>CM</sub> = 0	1	+25°C	-15	15	μA
			2, 3	+125°C, -55°C	-30	30	μA
Inverting Input (-IN) Current	I <sub>BSN</sub>	V <sub>CM</sub> = 0V	1	+25°C	-12	12	μA
			2, 3	+125°C, -55°C	-30	30	μA
-IN Current Common Mode Sensitivity	CMS <sub>IBN</sub>	ΔV <sub>CM</sub> = ±2.5V V+ = 2.5V, V- = -7.5V V+ = 7.5V, V- = -2.5V	1	+25°C	-	0.4	μA/V
			2	+125°C	-	5	μA/V
		3	-55°C	-	5	μA/V	

## Specifications HA5023/883

**TABLE 1. DC ELECTRICAL PERFORMANCE CHARACTERISTICS (Continued)**

Device Tested at:  $V_{SUPPLY} = \pm 5V$ ,  $A_V = +1$ ,  $R_F = 1k\Omega$ ,  $R_{SOURCE} = 0\Omega$ ,  $R_L = 400\Omega$ ,  $V_{OUT} = 0V$ , Unless Otherwise Specified.

PARAMETERS	SYMBOL	CONDITIONS	GROUP A SUBGROUPS	TEMPERATURE	LIMITS		UNITS
					MIN	MAX	
-IN Current Power Supply Sensitivity	PSS <sub>IBN</sub>	$\Delta V_{SUP} = \pm 1.5V$ $V_+ = 6.5V, V_- = -5V$ $V_+ = 3.5V, V_- = -5V$	1	+25°C	-	0.2	$\mu A/V$
			2, 3	+125°C, -55°C	-	0.5	$\mu A/V$
+IN Current Power Supply Sensitivity	PSS <sub>IBP</sub>	$\Delta V_{SUP} = \pm 1.5V$ $V_+ = 6.5V, V_- = -5V$ $V_+ = 3.5V, V_- = -5V$	1	+25°C	-	0.1	$\mu A/V$
			2, 3	+125°C, -55°C	-	0.3	$\mu A/V$
Output Voltage Swing	V <sub>OP</sub>	$A_V = +1$ $R_L = 150\Omega$ $V_{IN} = -3V$	1	+25°C	2.5	-	V
			2, 3	+125°C, -55°C	2.5	-	V
	V <sub>ON</sub>	$A_V = +1$ $R_L = 150\Omega$ $V_{IN} = +3V$	1	+25°C	-	-2.5	V
			2, 3	+125°C, -55°C	-	-2.5	V
Short Circuit Output Current	+I <sub>SC</sub>	$V_{IN} = \pm 2.5V$ $V_{OUT} = 0V$	1	+25°C	50	-	mA
			2, 3	+125°C, -55°C	50	-	mA
	-I <sub>SC</sub>	$V_{IN} = \pm 2.5V$ $V_{OUT} = 0V$	1	+25°C	-	-40	mA
			2, 3	+125°C, -55°C	-	-40	mA
Output Current	+I <sub>OUT</sub>	Note 1	1	+25°C	20	-	mA
			2, 3	+125°C, -55°C	16.6	-	mA
	-I <sub>OUT</sub>	Note 1	1	+25°C	-	-20	mA
			2, 3	+125°C, -55°C	-	-16.6	mA
Quiescent Power Supply Current	I <sub>CC</sub>	$R_L = 400\Omega$	1	+25°C	-	10	mA/Op Amp
			2, 3	+125°C, -55°C	-	10	mA/Op Amp
	I <sub>EE</sub>	$R_L = 400\Omega$	1	+25°C	-10	-	mA/Op Amp
			2, 3	+125°C, -55°C	-10	-	mA/Op Amp
Transimpedance	+A <sub>ZOL1</sub>	$R_L = 400\Omega$ $V_{OUT} = \pm 2.5V$	1	+25°C	1	-	M $\Omega$
			2, 3	+125°C	0.5	-	M $\Omega$
		3	-55°C	0.5	-	M $\Omega$	
	-A <sub>ZOL1</sub>	$R_L = 400\Omega$ $V_{OUT} = \pm 2.5V$	1	+25°C	1	-	M $\Omega$
			2, 3	+125°C	0.5	-	M $\Omega$
		3	-55°C	0.5	-	M $\Omega$	

NOTE:

1. Guaranteed from V<sub>OUT</sub> Test with R<sub>L</sub> = 150 $\Omega$ , by: I<sub>OUT</sub> = V<sub>OUT</sub>/150 $\Omega$ .

**TABLE 2. AC ELECTRICAL PERFORMANCE CHARACTERISTICS**

Table 2 Intentionally Left Blank.

## Specifications HA5023/883

**TABLE 3. ELECTRICAL PERFORMANCE CHARACTERISTICS**

Device Characterized at:  $V_{SUPPLY} = \pm 5V$ ,  $A_V = +2$ ,  $R_F = 681\Omega$ ,  $R_L = 400\Omega$ , Unless Otherwise Specified.

PARAMETERS	SYMBOL	CONDITIONS	NOTES	TEMPERATURE	LIMITS		UNITS
					MIN	MAX	
-3dB Bandwidth	BW(+1)	$A_V = +1$ , $R_F = 1K$ $V_{OUT} = 100mV_{RMS}$	1	+125°C, -55°C	62	-	MHz
	BW(+2)	$A_V = +2$ , $V_{OUT} = 100mV_{RMS}$	1	+125°C, -55°C	62	-	MHz
Gain Flatness	GF5	$A_V = +2$ , $f \leq 5MHz$ $V_{OUT} = 100mV_{RMS}$	1	+125°C, -55°C	-	$\pm 0.045$	dB
	GF10	$A_V = +2$ , $f \leq 10MHz$ $V_{OUT} = 100mV_{RMS}$	1	+125°C, -55°C	-	$\pm 0.085$	dB
	GF20	$A_V = +2$ , $f \leq 20MHz$ $V_{OUT} = 100mV_{RMS}$	1	+125°C, -55°C	-	$\pm 0.65$	dB
Slew Rate	+SR(+1)	$A_V = +1$ , $R_F = 1K$ $V_{OUT} = -2V$ to $+2V$	1, 4	+125°C, -55°C	250	-	V/ $\mu s$
	-SR(+1)	$A_V = +1$ , $R_F = 1K$ $V_{OUT} = +2V$ to $-2V$	1, 4	+125°C, -55°C	240	-	V/ $\mu s$
	+SR(+2)	$A_V = +2$ , $V_{OUT} = -2V$ to $+2V$	1, 4	+125°C, -55°C	400	-	V/ $\mu s$
	-SR(+2)	$A_V = +2$ , $V_{OUT} = +2V$ to $-2V$	1, 4	+125°C, -55°C	360	-	V/ $\mu s$
Rise and Fall Time	$T_R$	$A_V = +2$ , $V_{OUT} = -0.5V$ to $+0.5V$	1, 2	+125°C, -55°C	-	6.5	ns
	$T_F$	$A_V = +2$ , $V_{OUT} = +0.5V$ to $-0.5V$	1, 2	+125°C, -55°C	-	6.5	ns
Overshoot	+OS	$A_V = +2$ , $V_{OUT} = -0.5V$ to $+0.5V$	1, 3	+125°C, -55°C	-	35	%
	-OS	$A_V = +2$ , $V_{OUT} = +0.5V$ to $-0.5V$	1, 3	+125°C, -55°C	-	27	%
Propagation Delay	+ $T_P$	$A_V = +2$ , $R_F = 681\Omega$ $V_{OUT} = 0V$ to $1V$	1, 2	+125°C, -55°C	-	9.5	ns
	- $T_P$	$A_V = +2$ , $R_F = 681\Omega$ $V_{OUT} = 1V$ to $0V$	1, 2	+125°C, -55°C	-	9.0	ns

**NOTES:**

- Parameters listed in Table 3 are controlled via design or process parameters and are not directly tested at final production. These parameters are lab characterized upon initial design release, or upon design changes. These parameters are guaranteed by characterization based upon data from multiple production runs which reflect lot-to-lot and within lot variation.
- Measured between 10% and 90% points.
- For 200ps input transition times. Overshoot decreases as input transition times increase, especially for  $A_V = +1$ . Please refer to Performance Curves.
- Measured between 25% and 75% points.

**TABLE 4. ELECTRICAL TEST REQUIREMENTS**

MIL-STD-883 TEST REQUIREMENTS	SUBGROUPS (SEE TABLE 1)
Interim Electrical Parameters (Pre Burn-In)	1
Final Electrical Test Parameters	1 (Note 1), 2, 3, 4
Group A Test Requirements	1, 2, 3, 4
Groups C and D Endpoints	1

**NOTE:**

- PDA applies to Subgroup 1 only.

Test Circuits and Waveforms

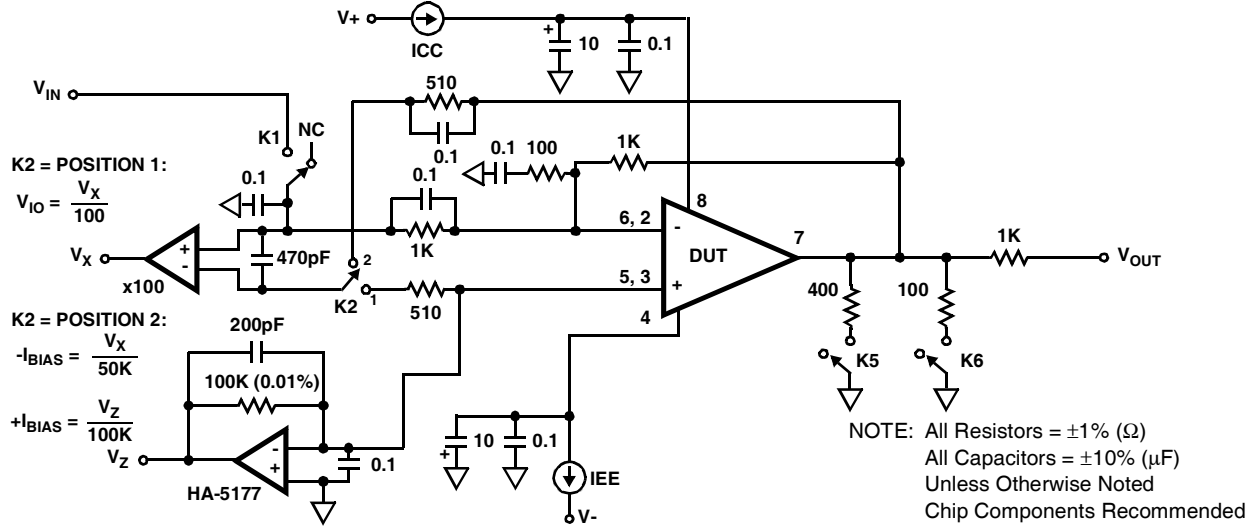

FIGURE 1. TEST CIRCUIT (Applies to Table 1)

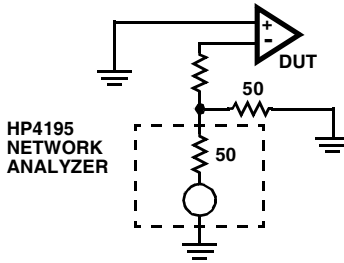

FIGURE 2. TEST CIRCUIT FOR TRANSIMPEDANCE MEASUREMENTS

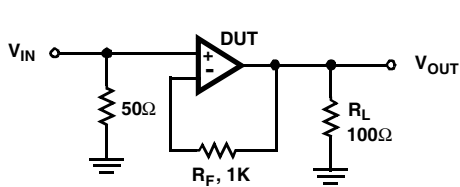

FIGURE 3. SMALL SIGNAL PULSE RESPONSE CIRCUIT

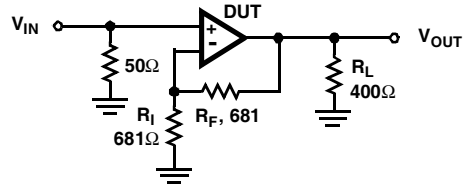

FIGURE 4. LARGE SIGNAL PULSE RESPONSE CIRCUIT

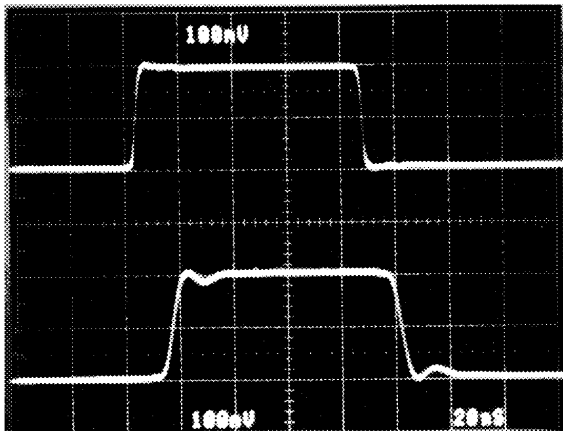

FIGURE 5. SMALL SIGNAL RESPONSE  
Vertical Scale:  $V_{IN} = 100\text{mV}/\text{Div.}$ ,  $V_{OUT} = 100\text{mV}/\text{Div.}$   
Horizontal Scale:  $20\text{ns}/\text{Div.}$

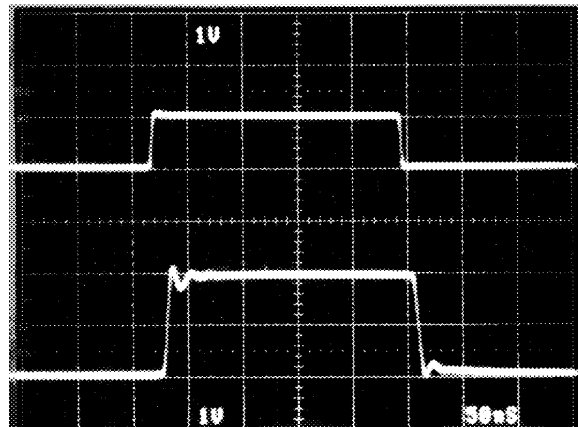
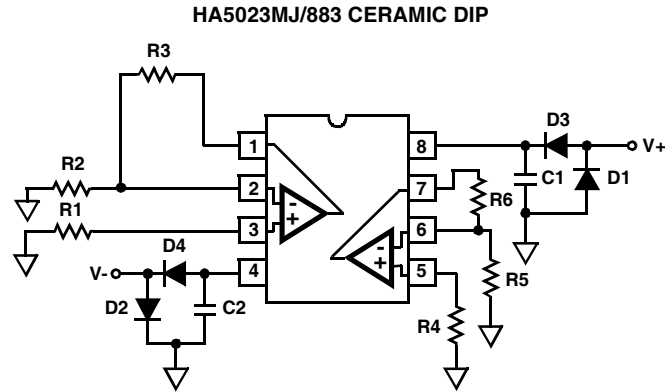

FIGURE 6. LARGE SIGNAL RESPONSE  
Vertical Scale:  $V_{IN} = 1\text{V}/\text{Div.}$ ,  $V_{OUT} = 1\text{V}/\text{Div.}$   
Horizontal Scale:  $50\text{ns}/\text{Div.}$

**Burn-In Circuit**



NOTES:

- R1 = R2 = R4 = R5 = 1k $\Omega$ ,  $\pm$ 5% (Per Socket)
- R3 = R6 = 10k $\Omega$ ,  $\pm$ 5% (Per Socket)
- C1 = C2 = 0.01 $\mu$ F (Per Socket) or 0.1 $\mu$ F (Per Row) Minimum
- D1 = D2 = 1N4002 or Equivalent (Per Board)
- D3 = D4 = 1N4002 or Equivalent (Per Socket)
- V+ = +5.5V  $\pm$  0.5V
- V- = -5.5V  $\pm$  0.5V

**Die Characteristics**

**DIE DIMENSIONS:**

65 x 100 x 19 mils ± 1 mils  
 1650 x 2540 x 483µm ± 25.4µm

**METALLIZATION:**

Type: Metal 1: AlCu (1%), Metal 2: AlCu (1%)  
 Thickness: Metal 1: 8kÅ ± 0.4kÅ, Metal 2: 16kÅ ± 0.8kÅ

**WORST CASE CURRENT DENSITY:**

1.9 x 10<sup>5</sup> A/cm<sup>2</sup> at 15mA

**SUBSTRATE POTENTIAL (Powered Up): V-**

**GLASSIVATION:**

Type: Nitride  
 Thickness: 4kÅ ± 0.4kÅ

**TRANSISTOR COUNT: 124**

**PROCESS: Bipolar Dielectric Isolation**

**Metallization Mask Layout**

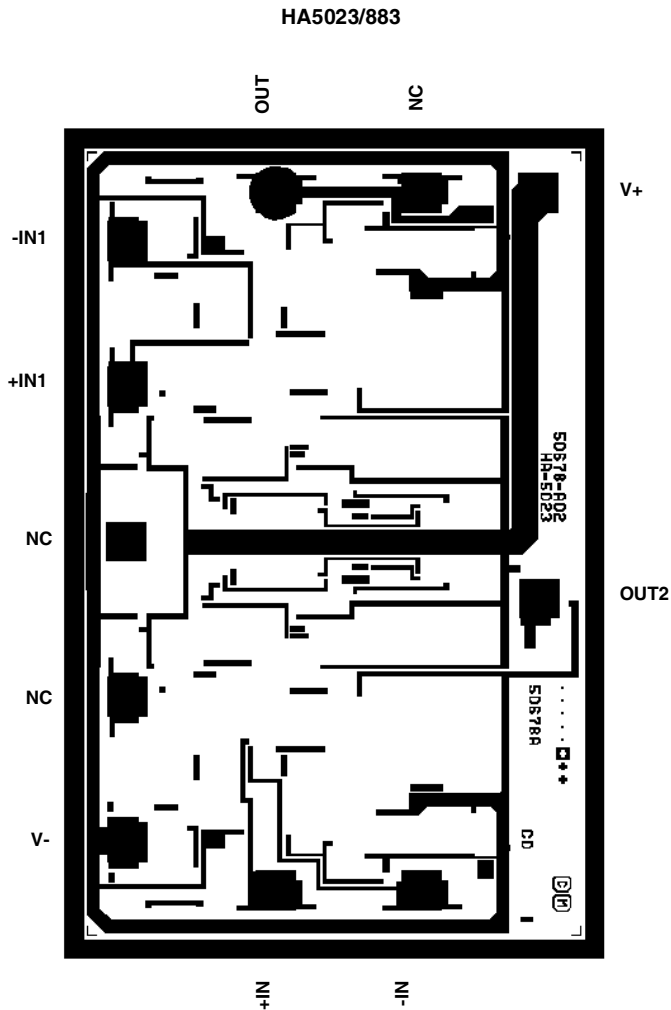

**Ceramic Dual-In-Line Frit Seal Packages (CerDIP)**

**F8.3A MIL-STD-1835 GDIP1-T8 (D-4, CONFIGURATION A)  
8 LEAD CERAMIC DUAL-IN-LINE FRIT SEAL PACKAGE**

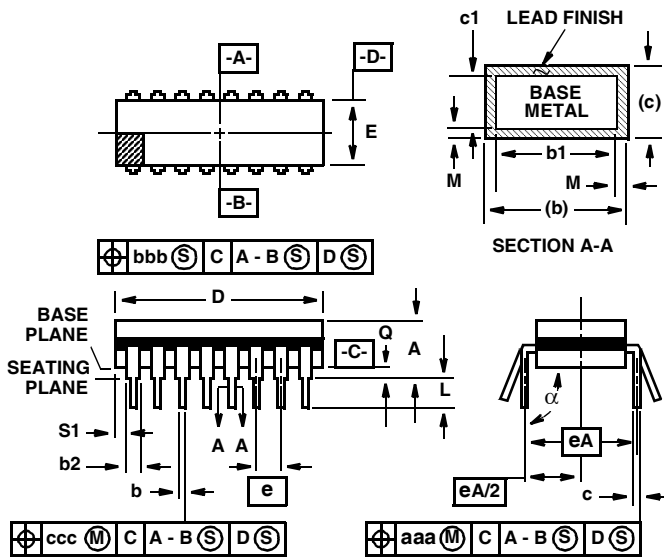

SYMBOL	INCHES		MILLIMETERS		NOTES
	MIN	MAX	MIN	MAX	
A	-	0.200	-	5.08	-
b	0.014	0.026	0.36	0.66	2
b1	0.014	0.023	0.36	0.58	3
b2	0.045	0.065	1.14	1.65	-
b3	0.023	0.045	0.58	1.14	4
c	0.008	0.018	0.20	0.46	2
c1	0.008	0.015	0.20	0.38	3
D	-	0.405	-	10.29	5
E	0.220	0.310	5.59	7.87	5
e	0.100 BSC		2.54 BSC		-
eA	0.300 BSC		7.62 BSC		-
eA/2	0.150 BSC		3.81 BSC		-
L	0.125	0.200	3.18	5.08	-
Q	0.015	0.060	0.38	1.52	6
S1	0.005	-	0.13	-	7
alpha	90°	105°	90°	105°	-
aaa	-	0.015	-	0.38	-
bbb	-	0.030	-	0.76	-
ccc	-	0.010	-	0.25	-
M	-	0.0015	-	0.038	2, 3
N	8		8		8

**NOTES:**

1. Index area: A notch or a pin one identification mark shall be located adjacent to pin one and shall be located within the shaded area shown. The manufacturer's identification shall not be used as a pin one identification mark.
2. The maximum limits of lead dimensions b and c or M shall be measured at the centroid of the finished lead surfaces, when solder dip or tin plate lead finish is applied.
3. Dimensions b1 and c1 apply to lead base metal only. Dimension M applies to lead plating and finish thickness.
4. Corner leads (1, N, N/2, and N/2+1) may be configured with a partial lead paddle. For this configuration dimension b3 replaces dimension b2.
5. This dimension allows for off-center lid, meniscus, and glass overrun.
6. Dimension Q shall be measured from the seating plane to the base plane.
7. Measure dimension S1 at all four corners.
8. N is the maximum number of terminal positions.
9. Dimensioning and tolerancing per ANSI Y14.5M - 1982.
10. Controlling dimension: INCH.

Rev. 0 4/94



## DESIGN INFORMATION

## Dual 125MHz Video Current Feedback Amplifier

January 1995

The information contained in this section has been developed through characterization by Intersil Corporation and is for use as application and design information only. No guarantee is implied.

**Typical Performance Curves**  $V_{SUPPLY} = \pm 5V$ ,  $A_V = +1$ ,  $R_F = 1k\Omega$ ,  $R_L = 400\Omega$ ,  $T_A = 25^\circ C$ , Unless Otherwise Specified.

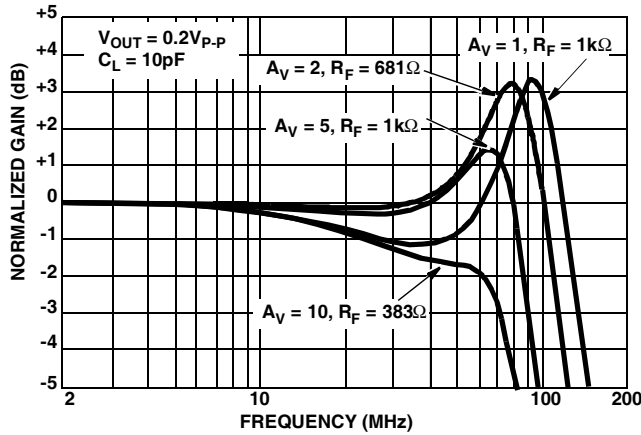

FIGURE 1. NON-INVERTING FREQUENCY RESPONSE

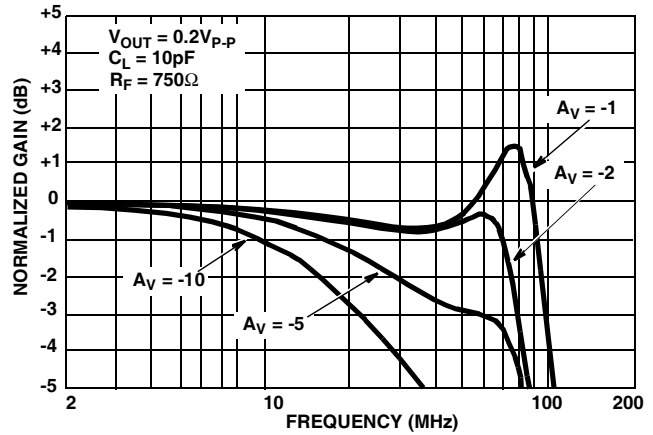

FIGURE 2. INVERTING FREQUENCY RESPONSE

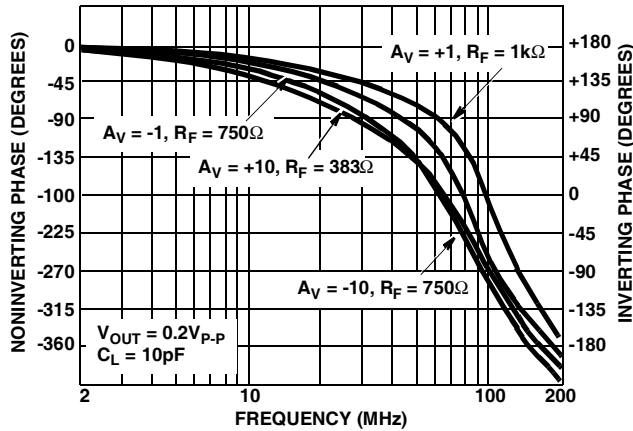

FIGURE 3. PHASE RESPONSE AS A FUNCTION OF FREQUENCY

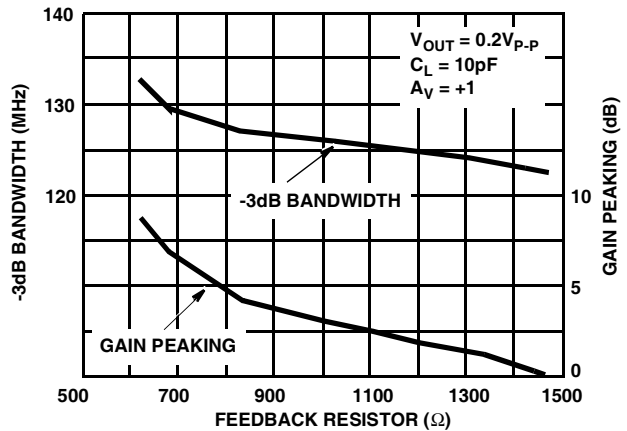

FIGURE 4. BANDWIDTH AND GAIN PEAKING vs FEEDBACK RESISTANCE

## DESIGN INFORMATION (Continued)

The information contained in this section has been developed through characterization by Intersil Corporation and is for use as application and design information only. No guarantee is implied.

**Typical Performance Curves**  $V_{SUPPLY} = \pm 5V$ ,  $A_V = +1$ ,  $R_F = 1k\Omega$ ,  $R_L = 400\Omega$ ,  $T_A = 25^\circ C$ , Unless Otherwise Specified.  
(Continued)

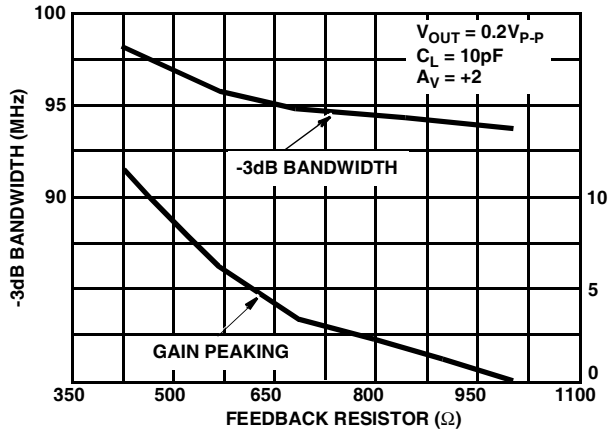

FIGURE 5. BANDWIDTH AND GAIN PEAKING vs FEEDBACK RESISTANCE

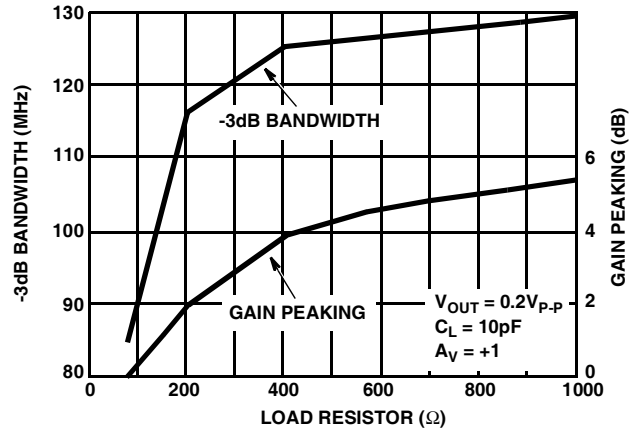

FIGURE 6. BANDWIDTH AND GAIN PEAKING vs LOAD RESISTANCE

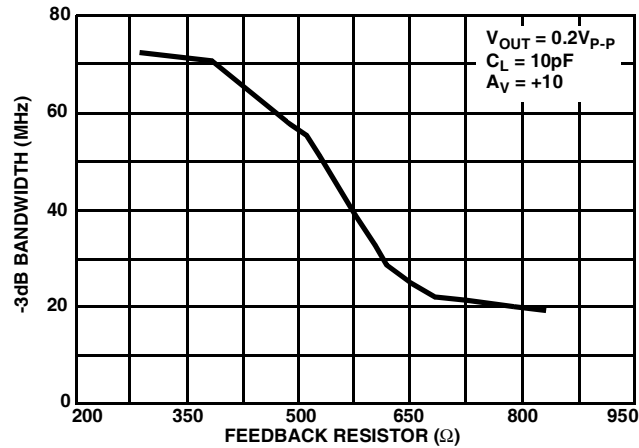

FIGURE 7. BANDWIDTH vs FEEDBACK RESISTANCE

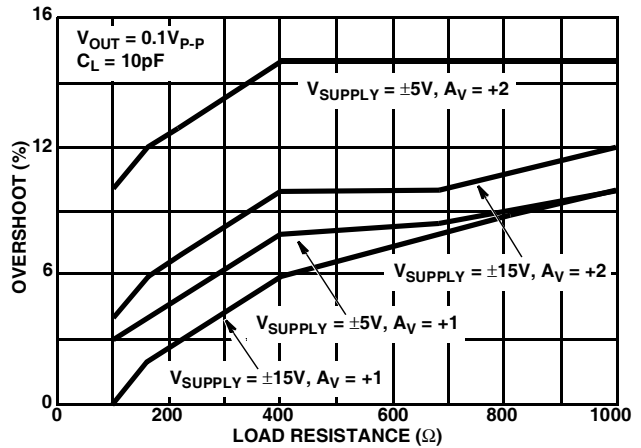

FIGURE 8. SMALL SIGNAL OVERSHOOT vs LOAD RESISTANCE

## DESIGN INFORMATION (Continued)

The information contained in this section has been developed through characterization by Intersil Corporation and is for use as application and design information only. No guarantee is implied.

**Typical Performance Curves**  $V_{SUPPLY} = \pm 5V$ ,  $A_V = +1$ ,  $R_F = 1k\Omega$ ,  $R_L = 400\Omega$ ,  $T_A = 25^\circ C$ , Unless Otherwise Specified.  
(Continued)

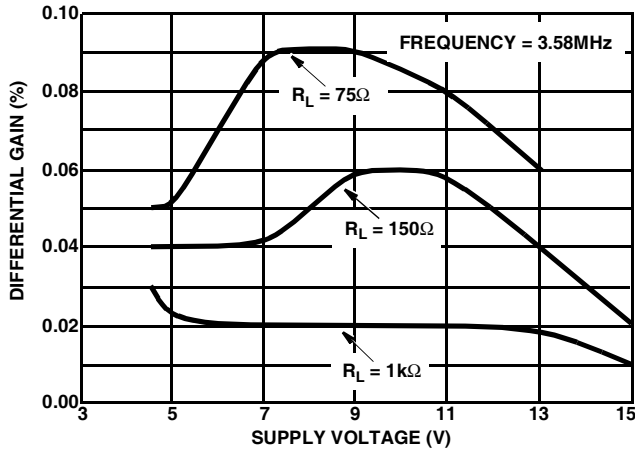

FIGURE 9. DIFFERENTIAL GAIN vs SUPPLY VOLTAGE

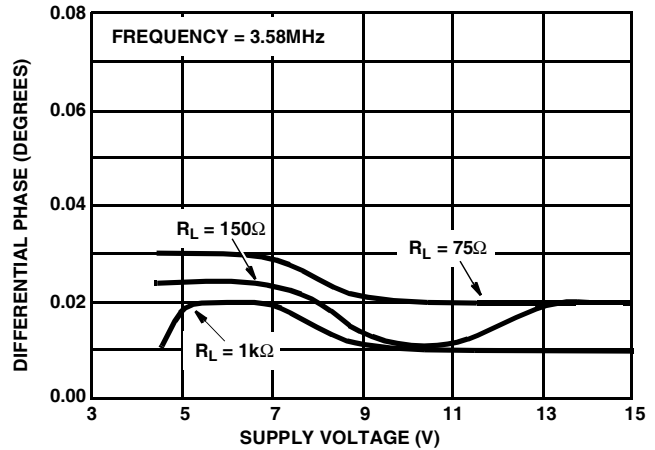

FIGURE 10. DIFFERENTIAL PHASE vs SUPPLY VOLTAGE

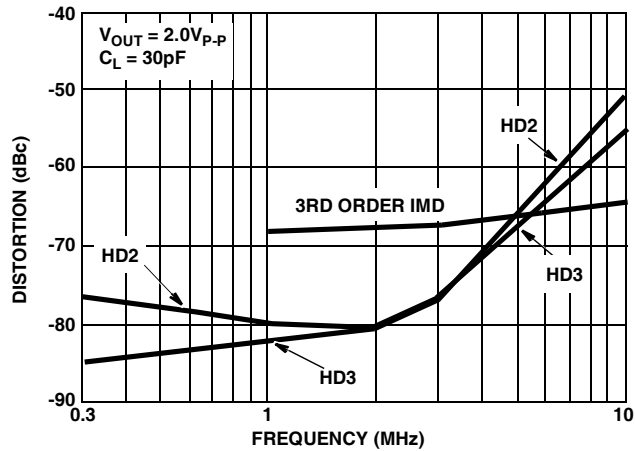

FIGURE 11. DISTORTION vs FREQUENCY

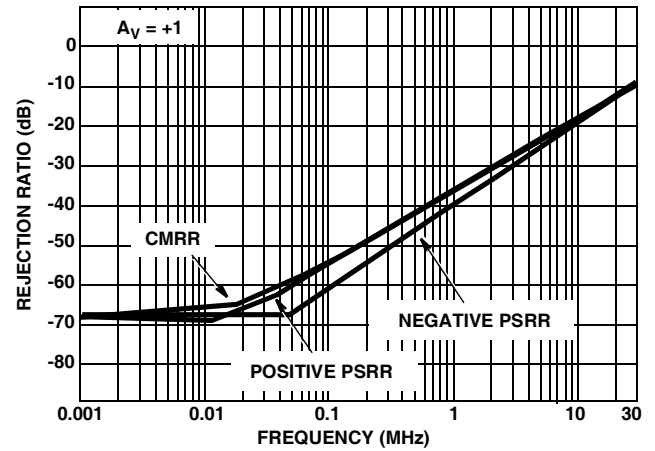

FIGURE 12. REJECTION RATIOS vs FREQUENCY

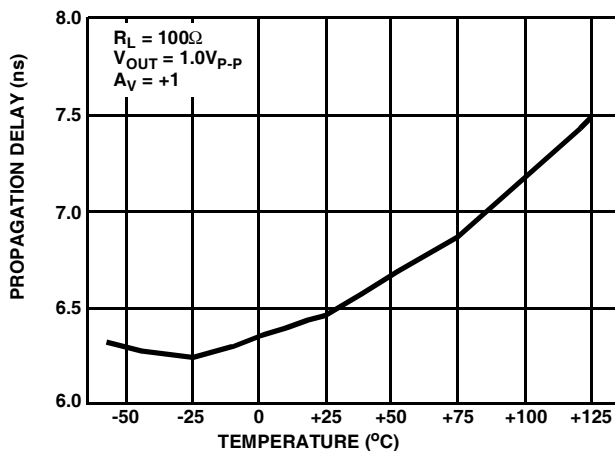

FIGURE 13. PROPAGATION DELAY vs TEMPERATURE

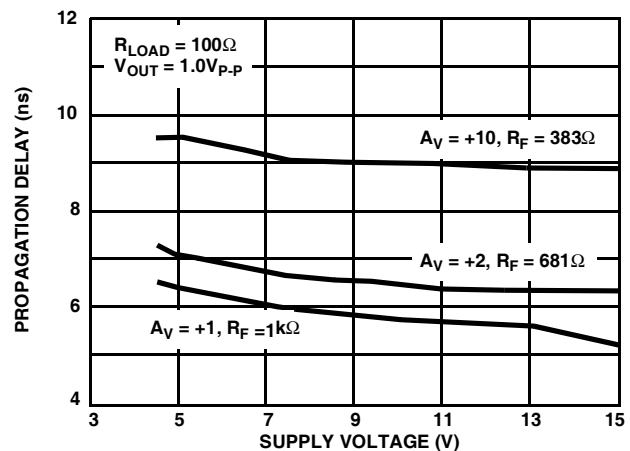

FIGURE 14. PROPAGATION DELAY vs SUPPLY VOLTAGE

## DESIGN INFORMATION (Continued)

The information contained in this section has been developed through characterization by Intersil Corporation and is for use as application and design information only. No guarantee is implied.

**Typical Performance Curves**  $V_{SUPPLY} = \pm 5V$ ,  $A_V = +1$ ,  $R_F = 1k\Omega$ ,  $R_L = 400\Omega$ ,  $T_A = 25^\circ C$ , Unless Otherwise Specified.  
(Continued)

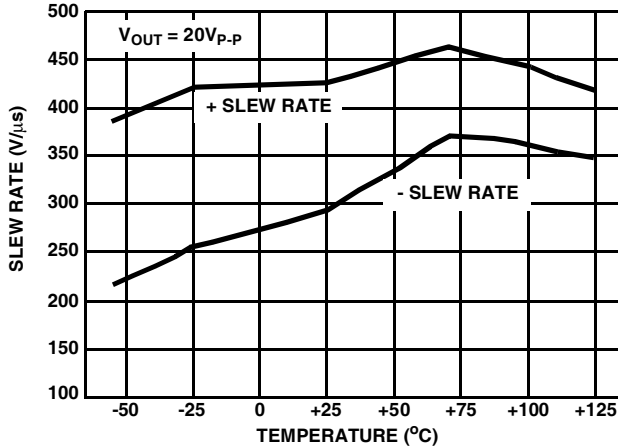

FIGURE 15. SLEW RATE vs TEMPERATURE

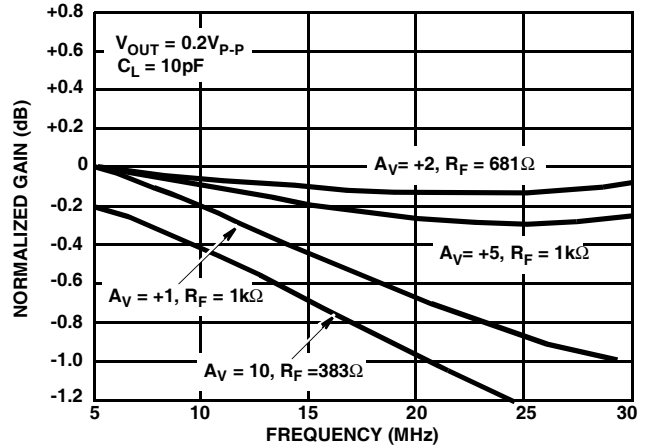

FIGURE 16. NON-INVERTING GAIN FLATNESS vs FREQUENCY

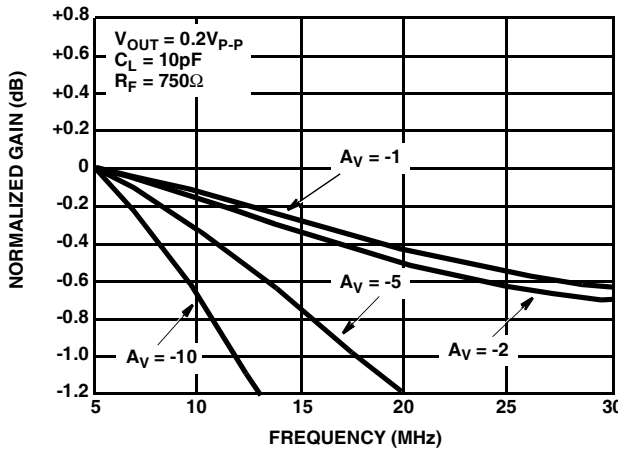

FIGURE 17. INVERTING GAIN FLATNESS vs FREQUENCY

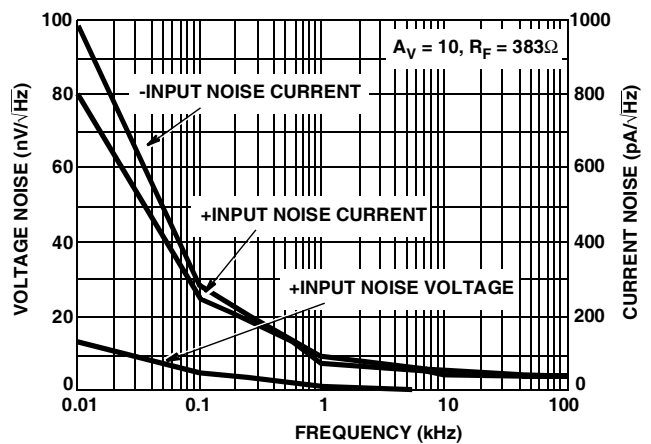

FIGURE 18. INPUT NOISE CHARACTERISTICS

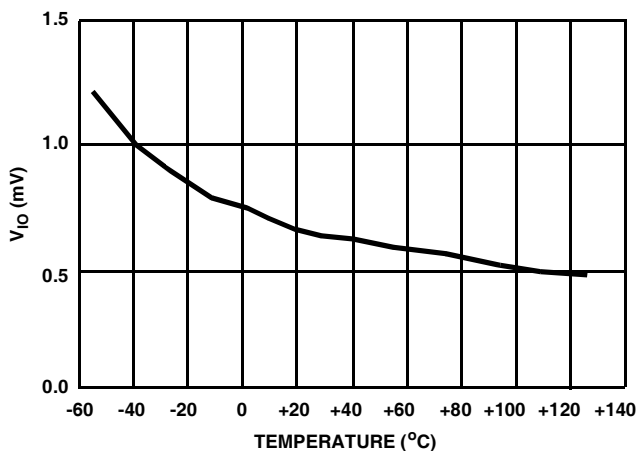

FIGURE 19. INPUT OFFSET VOLTAGE vs TEMPERATURE

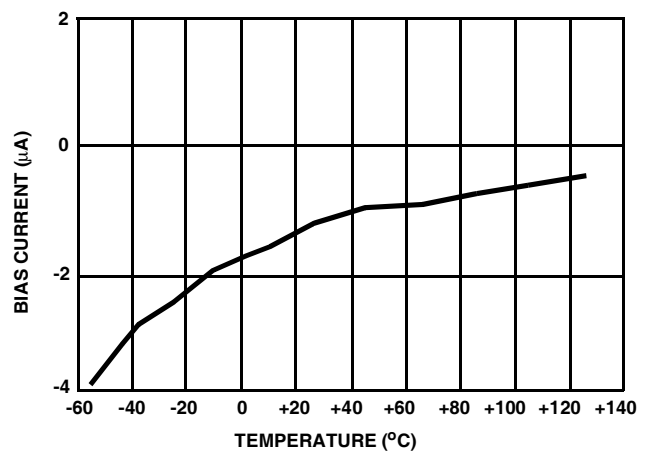

FIGURE 20. +INPUT BIAS CURRENT vs TEMPERATURE

## DESIGN INFORMATION (Continued)

The information contained in this section has been developed through characterization by Intersil Corporation and is for use as application and design information only. No guarantee is implied.

**Typical Performance Curves**  $V_{SUPPLY} = \pm 5V$ ,  $A_V = +1$ ,  $R_F = 1k\Omega$ ,  $R_L = 400\Omega$ ,  $T_A = 25^\circ C$ , Unless Otherwise Specified.  
(Continued)

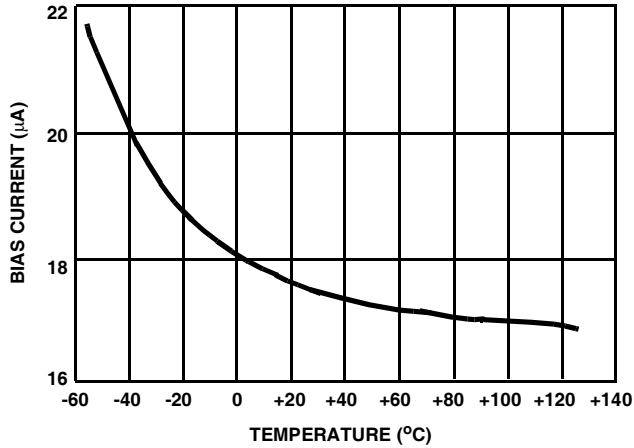

FIGURE 21. -INPUT BIAS CURRENT vs TEMPERATURE

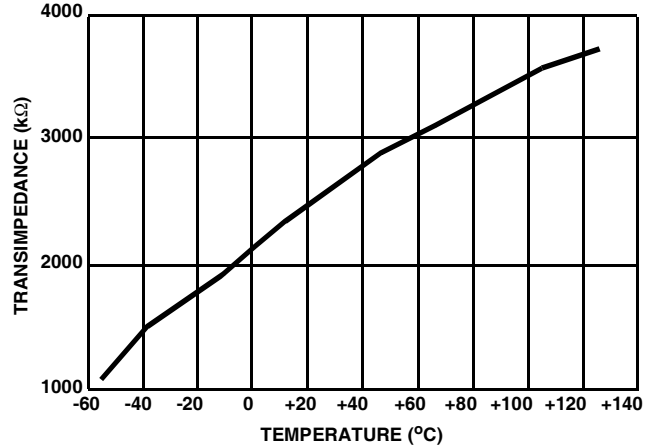

FIGURE 22. TRANSIMPEDANCE vs TEMPERATURE

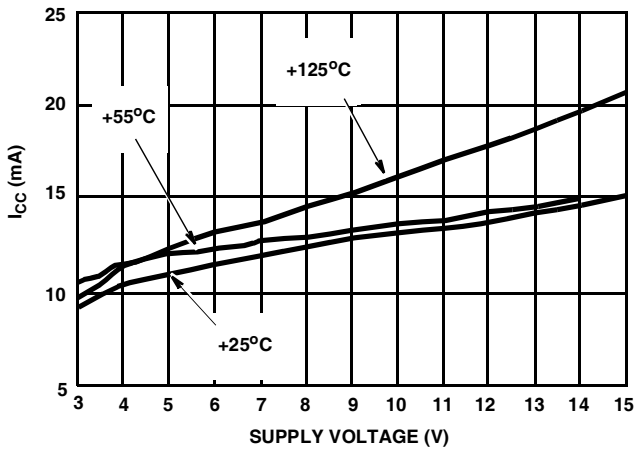

FIGURE 23. SUPPLY CURRENT vs SUPPLY VOLTAGE

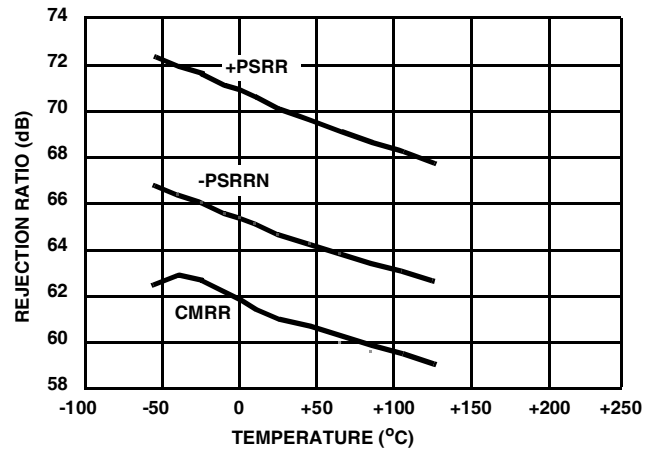

FIGURE 24. REJECTION RATIO vs TEMPERATURE

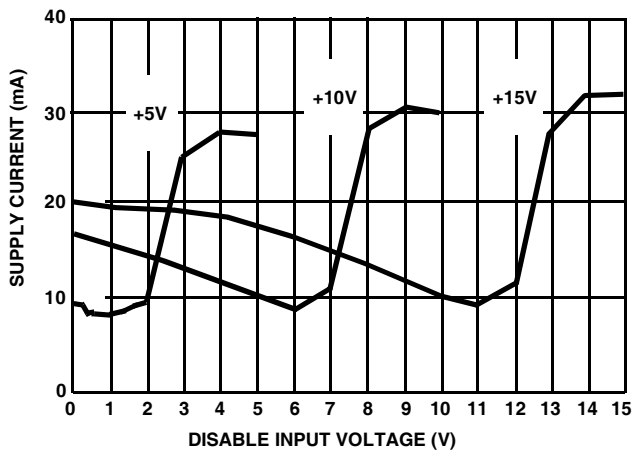

FIGURE 25. SUPPLY CURRENT vs DISABLE INPUT VOLTAGE

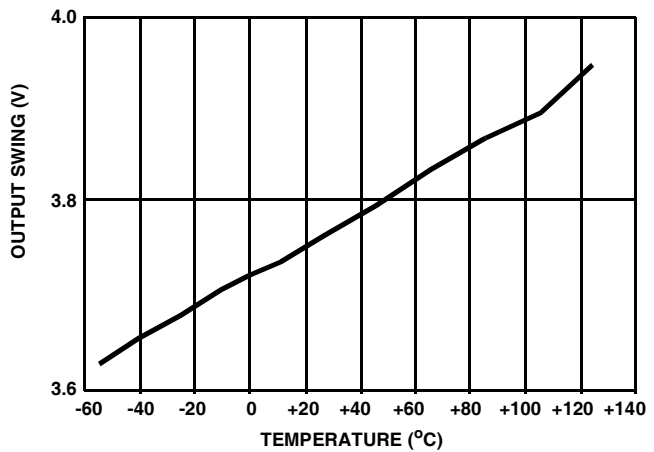

FIGURE 26. OUTPUT SWING vs TEMPERATURE

**Typical Performance Curves**  $V_{SUPPLY} = \pm 5V$ ,  $A_V = +1$ ,  $R_F = 1k\Omega$ ,  $R_L = 400\Omega$ ,  $T_A = 25^\circ C$ , Unless Otherwise Specified.  
 (Continued)

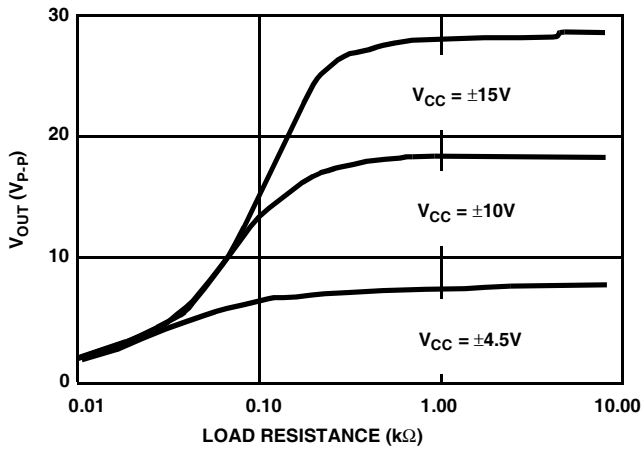

FIGURE 27. OUTPUT SWING vs LOAD RESISTANCE

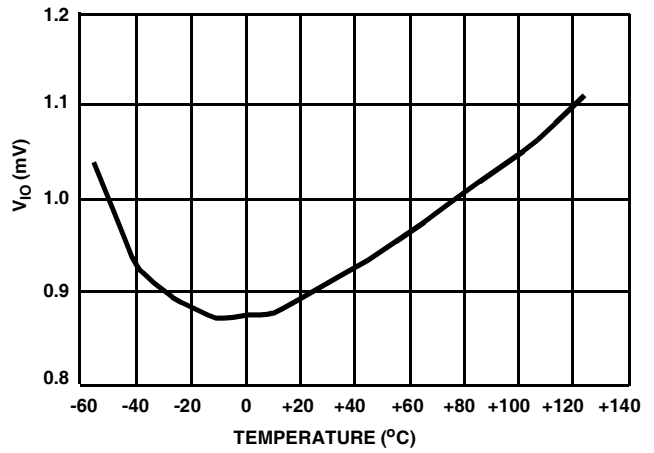

FIGURE 28. INPUT OFFSET VOLTAGE CHANGE BETWEEN CHANNELS vs TEMPERATURE

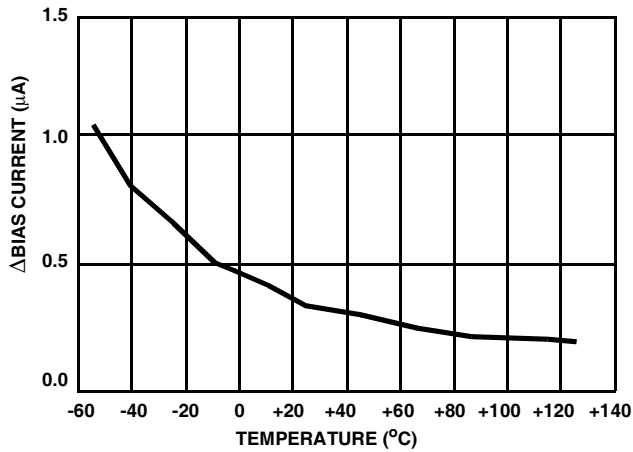

FIGURE 29. INPUT BIAS CURRENT CHANGE BETWEEN CHANNELS vs TEMPERATURE

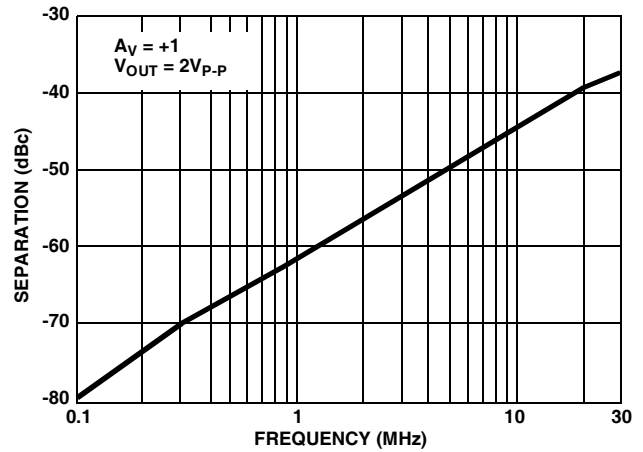

FIGURE 30. CHANNEL SEPARATION vs FREQUENCY

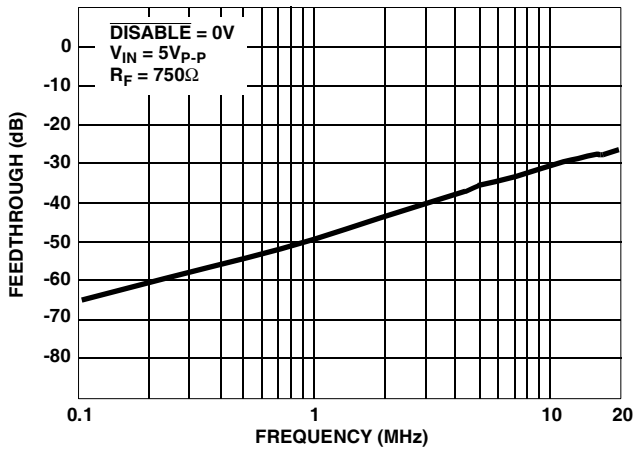

FIGURE 31. DISABLE FEEDTHROUGH vs FREQUENCY

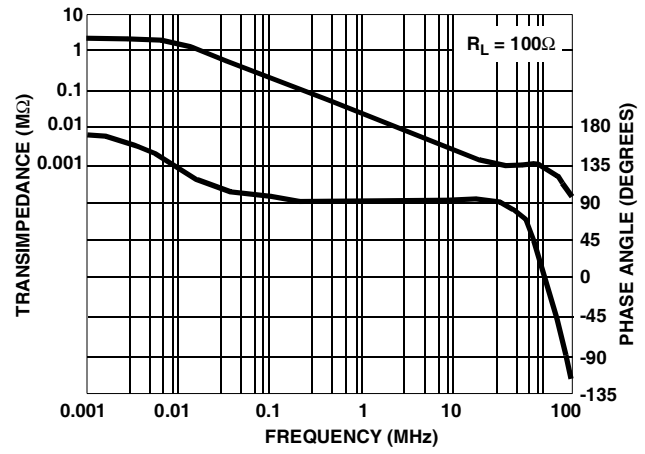

FIGURE 32. TRANSIMPEDANCE vs FREQUENCY

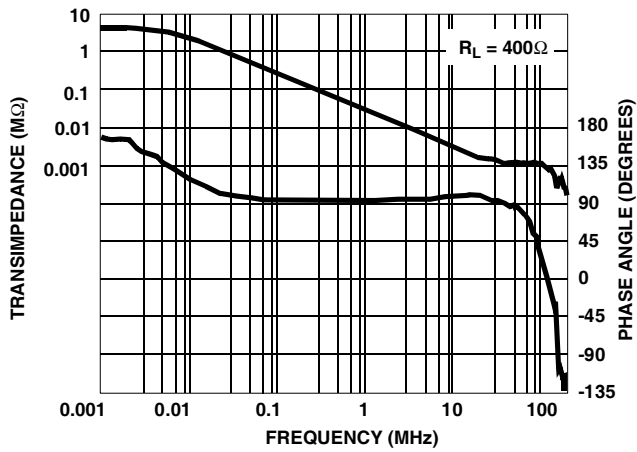

FIGURE 33. TRANSIMPEDANCE vs FREQUENCY

## DESIGN INFORMATION (Continued)

The information contained in this section has been developed through characterization by Intersil Corporation and is for use as application and design information only. No guarantee is implied.

### Application Information

#### Optimum Feedback Resistor

The plots of inverting and non-inverting frequency response, see Figure 1 and Figure 2 in the typical performance section, illustrate the performance of the HA5023 in various closed loop gain configurations. Although the bandwidth dependency on closed loop gain isn't as severe as that of a voltage feedback amplifier, there can be an appreciable decrease in bandwidth at higher gains. This decrease may be minimized by taking advantage of the current feedback amplifier's unique relationship between bandwidth and  $R_F$ . All current feedback amplifiers require a feedback resistor, even for unity gain applications, and  $R_F$ , in conjunction with the internal compensation capacitor, sets the dominant pole of the frequency response. Thus, the amplifier's bandwidth is inversely proportional to  $R_F$ . The HA5023 design is optimized for a  $1000\Omega$   $R_F$  at a gain of +1. Decreasing  $R_F$  in a unity gain application decreases stability, resulting in excessive peaking and overshoot. At higher gains the amplifier is more stable, so  $R_F$  can be decreased in a trade-off of stability for bandwidth.

The table below lists recommended  $R_F$  values for various gains, and the expected bandwidth.

GAIN ( $A_{CL}$ )	$R_F$ ( $\Omega$ )	BANDWIDTH (MHz)
-1	750	100
+1	1000	125
+2	681	95
+5	1000	52
+10	383	65
-10	750	22

#### PC Board Layout

The frequency response of this amplifier depends greatly on the amount of care taken in designing the PC board. The use of low inductance components such as chip resistors and chip capacitors is strongly recommended. If leaded components are used the leads must be kept short especially for the power supply decoupling components and those components connected to the inverting input.

Attention must be given to decoupling the power supplies. A large value ( $10\mu\text{F}$ ) tantalum or electrolytic capacitor in parallel with a small value ( $0.1\mu\text{F}$ ) chip capacitor works well in most cases.

A ground plane is strongly recommended to control noise. Care must also be taken to minimize the capacitance to ground seen by the amplifier's inverting input (-IN). The larger this capacitance, the worse the gain peaking, resulting in pulse overshoot and possible instability. It is recom-

mended that the ground plane be removed under traces connected to -IN, and that connections to -IN be kept as short as possible to minimize the capacitance from this node to ground.

#### Driving Capacitive Loads

Capacitive loads will degrade the amplifier's phase margin resulting in frequency response peaking and possible oscillations. In most cases the oscillation can be avoided by placing an isolation resistor (R) in series with the output as shown in Figure 34.

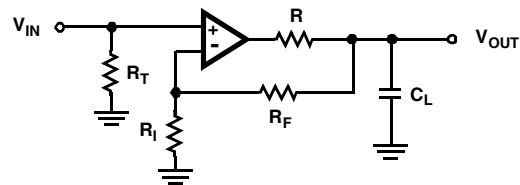

FIGURE 34. PLACEMENT OF THE OUTPUT ISOLATION RESISTOR, R

The selection criteria for the isolation resistor is highly dependent on the load, but  $27\Omega$  has been determined to be a good starting value.

#### Power Dissipation Considerations

Due to the high supply current inherent in dual amplifiers, care must be taken to insure that the maximum junction temperature ( $T_J$ , see Absolute Maximum Ratings) is not exceeded. Figure 35 shows the maximum ambient temperature versus supply voltage for the available package styles. It is recommended that thermal calculations, which take into account output power, be performed by the designer.

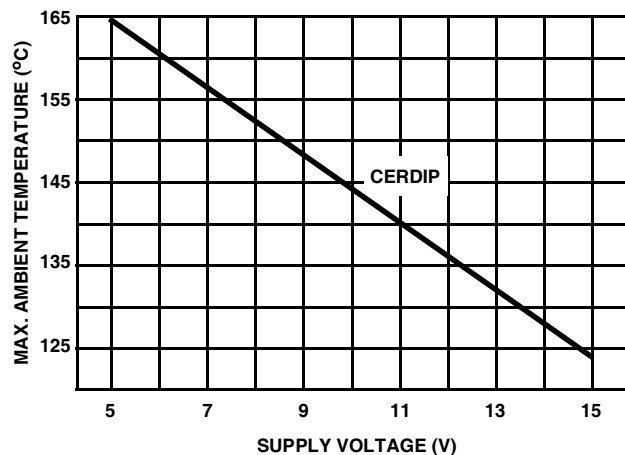

FIGURE 35. MAXIMUM OPERATING AMBIENT TEMPERATURE vs SUPPLY VOLTAGE



## Specifications HA5023

### DESIGN INFORMATION (Continued)

The information contained in this section has been developed through characterization by Intersil Corporation and is for use as application and design information only. No guarantee is implied.

#### Electrical Specifications $V_+ = +5V$ , $V_- = -5V$ , $R_F = 1k\Omega$ , $A_V = +1$ , $R_L = 400\Omega$ , $C_L \leq 10pF$ , Unless Otherwise Specified

PARAMETER	(NOTE 16) TEST LEVEL	TEMPERATURE	HA5023I			UNITS
			MIN	TYP	MAX	
<b>INPUT CHARACTERISTICS</b>						
Input Offset Voltage ( $V_{IO}$ )	A	+25°C	-	0.8	3	mV
	A	Full	-	-	5	mV
Delta $V_{IO}$ Between Channels	A	Full	-	1.2	3.5	mV
Average Input Offset Voltage Drift	B	Full	-	5	-	$\mu V/^\circ C$
$V_{IO}$ Common Mode Rejection Ratio (Note 3)	A	+25°C	53	-	-	dB
	A	Full	50	-	-	dB
$V_{IO}$ Power Supply Rejection Ratio (Note 4)	A	+25°C	60	-	-	dB
	A	Full	55	-	-	dB
Input Common Mode Range (Note 3)	A	Full	$\pm 2.5$	-	-	V
Non-Inverting Input (+IN) Current	A	+25°C	-	3	8	$\mu A$
	A	Full	-	-	20	$\mu A$
+IN Common Mode Rejection (Note 3) ( $+I_{BCMR} = \frac{1}{+R_{IN}}$ )	A	+25°C	-	-	0.15	$\mu A/V$
	A	Full	-	-	0.5	$\mu A/V$
+IN Power Supply Rejection (Note 4)	A	+25°C	-	-	0.1	$\mu A/V$
	A	Full	-	-	0.3	$\mu A/V$
Inverting Input (-IN) Current	A	+25°C, +85°C	-	4	12	$\mu A$
	A	-40°C	-	10	30	$\mu A$
Delta - IN BIAS Current Between Channels	A	+25°C, +85°C	-	6	15	$\mu A$
	A	-40°C	-	10	30	$\mu A$
-IN Common Mode Rejection (Note 3)	A	+25°C	-	-	0.4	$\mu A/V$
	A	Full	-	-	1.0	$\mu A/V$
-IN Power Supply Rejection (Note 4)	A	+25°C	-	-	0.2	$\mu A/V$
	A	Full	-	-	0.5	$\mu A/V$
Input Noise Voltage (f = 1kHz)	B	+25°C	-	4.5	-	$nV/\sqrt{Hz}$
+Input Noise Current (f = 1kHz)	B	+25°C	-	2.5	-	$pA/\sqrt{Hz}$
-Input Noise Current (f = 1kHz)	B	+25°C	-	25.0	-	$pA/\sqrt{Hz}$
<b>TRANSFER CHARACTERISTICS</b>						
Transimpedance (Note 14)	A	+25°C	1.0	-	-	$M\Omega$
	A	Full	0.85	-	-	$M\Omega$
Open Loop DC Voltage Gain, $R_L = 400\Omega$ , $V_{OUT} = \pm 2.5V$	A	+25°C	70	-	-	dB
	A	Full	65	-	-	dB
Open Loop DC Voltage Gain, $R_L = 100\Omega$ , $V_{OUT} = \pm 2.5V$	A	+25°C	50	-	-	dB
	A	Full	45	-	-	dB
<b>OUTPUT CHARACTERISTICS</b>						

## Specifications HA5023

### DESIGN INFORMATION (Continued)

The information contained in this section has been developed through characterization by Intersil Corporation and is for use as application and design information only. No guarantee is implied.

#### Electrical Specifications $V_+ = +5V$ , $V_- = -5V$ , $R_F = 1k\Omega$ , $A_V = +1$ , $R_L = 400\Omega$ , $C_L \leq 10pF$ , Unless Otherwise Specified (Continued)

PARAMETER	(NOTE 16) TEST LEVEL	TEMPERATURE	HA5023I			UNITS	
			MIN	TYP	MAX		
Output Voltage Swing (Note 13)	A	+25°C	±2.5	±3.0	-	V	
	A	Full	±2.5	±3.0	-	V	
Output Current (Note 13)	B	Full	±16.6	±20.0	-	mA	
Output Current (Short Circuit, Note 10)	A	Full	±40	±60	-	mA	
POWER SUPPLY CHARACTERISTICS							
Supply Voltage Range	A	+25°C	5	-	15	V	
Quiescent Supply Current	A	Full	-	7.5	10	mA/Op Amp	
AC CHARACTERISTICS ( $A_V = +1$ )							
Slew Rate (Note 5)	B	+25°C	275	350	-	V/μs	
Full Power Bandwidth (Note 6)	B	+25°C	22	28	-	MHz	
Rise Time (Note 7)	B	+25°C	-	6	-	ns	
Fall Time (Note 7)	B	+25°C	-	6	-	ns	
Propagation Delay (Note 7)	B	+25°C	-	6	-	ns	
Overshoot	B	+25°C	-	4.5	-	%	
-3dB Bandwidth (Note 8)	B	+25°C	-	125	-	MHz	
Settling Time to 1%, 2V Output Step	B	+25°C	-	50	-	ns	
Settling Time to 0.25%, 2V Output Step	B	+25°C	-	75	-	ns	
AC CHARACTERISTICS ( $A_V = +2$ , $R_F = 681\Omega$ )							
Slew Rate (Note 5)	B	+25°C	-	475	-	V/μs	
Full Power Bandwidth (Note 6)	B	+25°C	-	26	-	MHz	
Rise Time (Note 7)	B	+25°C	-	6	-	ns	
Fall Time (Note 7)	B	+25°C	-	6	-	ns	
Propagation Delay (Note 7)	B	+25°C	-	6	-	ns	
Overshoot	B	+25°C	-	12	-	%	
-3dB Bandwidth (Note 8)	B	+25°C	-	95	-	MHz	
Settling Time to 1%, 2V Output Step	B	+25°C	-	50	-	ns	
Settling Time to 0.25%, 2V Output Step	B	+25°C	-	100	-	ns	
Gain Flatness	5MHz	B	+25°C	-	0.02	-	dB
	20MHz	B	+25°C	-	0.07	-	dB
AC CHARACTERISTICS ( $A_V = +10$ , $R_F = 383\Omega$ )							
Slew Rate (Note 5)	B	+25°C	350	475	-	V/μs	
Full Power Bandwidth (Note 6)	B	+25°C	28	38	-	MHz	
Rise Time (Note 7)	B	+25°C	-	8	-	ns	
Fall Time (Note 7)	B	+25°C	-	9	-	ns	
Propagation Delay (Note 7)	B	+25°C	-	9	-	ns	

## Specifications HA5023

### Electrical Specifications $V_+ = +5V$ , $V_- = -5V$ , $R_F = 1k\Omega$ , $A_V = +1$ , $R_L = 400\Omega$ , $C_L \leq 10pF$ , Unless Otherwise Specified (Contin-

PARAMETER	(NOTE 16) TEST LEVEL	TEMPERATURE	HA5023I			UNITS
			MIN	TYP	MAX	
Overshoot	B	+25°C	-	1.8	-	%
-3dB Bandwidth (Note 8)	B	+25°C	-	65	-	MHz
Settling Time to 1%, 2V Output Step	B	+25°C	-	75	-	ns
Settling Time to 0.1%, 2V Output Step	B	+25°C	-	130	-	ns
VIDEO CHARACTERISTICS						
Differential Gain (Notes 11, 13)	B	+25°C	-	0.03	-	%
Differential Phase (Notes 11, 13)	B	+25°C	-	0.03	-	Degrees

#### NOTES:

1. Absolute maximum ratings are limiting values, applied individually, beyond which the serviceability of the circuit may be impaired. Functional operation under any of these conditions is not necessarily implied.
2. Output is protected for short circuits to ground. Brief short circuits to ground will not degrade reliability, however, continuous (100% duty cycle) output current should not exceed 15mA for maximum reliability.
3.  $V_{CM} = \pm 2.5V$ . At -40°C Product is tested at  $V_{CM} = \pm 2.25V$  because Short Test Duration does not allow self heating.
4.  $\pm 3.5V \leq V_S \leq \pm 6.5V$
5.  $V_{OUT}$  switches from -2V to +2V, or from +2V to -2V. Specification is from the 25% to 75% points.
6.  $FPBW = \frac{\text{Slew Rate}}{2\pi V_{PEAK}}$ ;  $V_{PEAK} = 2V$
7.  $R_L = 100\Omega$ ,  $V_{OUT} = 1V$ . Measured from 10% to 90% points for rise/fall times; from 50% points of input and output for propagation delay.
8.  $R_L = 400\Omega$ ,  $V_{OUT} = 100mV$ .
9. A. Production Tested; B. Guaranteed Limit or Typical based on characterization; C. Design Typical for information only.
10.  $V_{IN} = \pm 2.5V$ ,  $V_{OUT} = 0V$ .
11. Measured with a VM700A video tester using an NTC-7 composite VITS.
12. Maximum power dissipation, including output load, must be designed to maintain junction temperature below +175°C for die, and below +150°C for plastic packages. See Applications Information section for safe operating area information.
13.  $R_L = 150\Omega$ .
14.  $V_{OUT} = \pm 2.5V$ . At -40°C Product is tested at  $V_{OUT} = \pm 2.25V$  because Short Test Duration does not allow self heating.
15. ESD protection is for human body model tested per MIL-STD - 883, Method 3015.7.
16. A. Production Tested; B. Guaranteed limit or Typical based on characterization; C. Design Typical for information only.

All Intersil U.S. products are manufactured, assembled and tested utilizing ISO9000 quality systems.  
Intersil Corporation's quality certifications can be viewed at [www.intersil.com/design/quality](http://www.intersil.com/design/quality)

*Intersil products are sold by description only. Intersil Corporation reserves the right to make changes in circuit design, software and/or specifications at any time without notice. Accordingly, the reader is cautioned to verify that data sheets are current before placing orders. Information furnished by Intersil is believed to be accurate and reliable. However, no responsibility is assumed by Intersil or its subsidiaries for its use; nor for any infringements of patents or other rights of third parties which may result from its use. No license is granted by implication or otherwise under any patent or patent rights of Intersil or its subsidiaries.*

For information regarding Intersil Corporation and its products, see [www.intersil.com](http://www.intersil.com)