

# NAIS

## POWER PhotoMOS RELAYS 1-channel (Form B) Type

# PhotoMOS RELAYS

### FEATURES

#### 1. High capacity

A maximum 0.5A load can be controlled with a 5 mA input current. The ON resistance is low at 2.8Ω (typ.)

#### 2. 1 Form B

This has been realized thanks to the built-in MOSFET processed by our proprietary method, DSD (Double-diffused and Selective Doping) method.

#### 3. Compact slim-type 4-pin SIL

(W)3.5×(D)21.0×(H)12.5 mm  
(W).138×(D).827×(H).492 inch×  
The compact size of the 4-pin SIL package allows high density mounting.

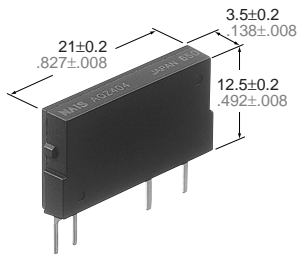

mm inch

Cross section of the normally-closed type of power MOS

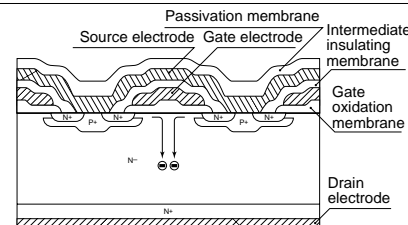

### TYPICAL APPLICATIONS

- Railroad, traffic signals
- Measurement instruments
- Testing equipment

### TYPES

AC/DC type

Output rating*		Part No.	Packing quantity	
Load voltage	Load current		Inner carton	Outer carton
400 V	0.5 A	AQZ404	25 pcs	500 pcs

### RATING

1) Absolute maximum ratings (Ambient temperature: 25°C 77°F)

Item		Symbol	AQZ104	Remarks
Input	LED forward current	$I_F$	50 mA	
	LED reverse voltage	$V_R$	3 V	
	Peak forward current	$I_{FP}$	1 A	f = 100 Hz, Duty factor = 0.1%
	Power dissipation	$P_{in}$	75 mW	
Output	Load voltage (Peak AC)	$V_L$	400 V	
	Continuous load current (Peak AC)	$I_L$	0.5 A	
	Peak load current	$I_{peak}$	1.5 A	100 ms (1 shot), $V_L = DC$
	Power dissipation	$P_{out}$	1.6 W	
Total power dissipation		$P_T$	1.6 W	
I/O isolation voltage		$V_{iso}$	2,500 V AC	
Temperature limits	Operating	$T_{opr}$	-40°C to +85°C -40°F to +185°F	Non-condensing at low temperatures
	Storage	$T_{stg}$	-40°C to +100°C -40°F to +212°F	

# AQZ404

## 2) Electrical characteristics (Ambient temperature: 25°C 77°F)

Item		Symbol	AQZ404	Condition		
Input	LED operate (OFF) current	Typical	1.0 mA	$I_L = 100 \text{ mA}$		
		Maximum	3.0 mA	$V_L = 10 \text{ V}$		
	LED reverse (ON) current	Minimum	0.4 mA	$I_L = 100 \text{ mA}$		
		Typical	0.9 mA	$V_L = 10 \text{ V}$		
LED dropout voltage	Typical	$V_F$	1.25 V (1.16 V at $I_F = 10 \text{ mA}$ )	$I_F = 50 \text{ mA}$		
	Maximum		1.5 V			
Output	On resistance	Typical	2.8 $\Omega$	$I_F = 0$		
		Maximum	4.0 $\Omega$	$I_L = \text{Max.}$ Within 1 s on time		
	Off state leakage current	Maximum	$I_{Leak}$	10 $\mu\text{A}$	$I_F = 10 \text{ mA}$ $V_L = \text{Max.}$	
Transfer characteristics	Switching speed	Operating (OFF) time*	Typical	$T_{off}$	3.9 ms	$I_F = 0 \rightarrow 10 \text{ mA}$
			Maximum		7.5 ms	$I_L = 100 \text{ mA}$ $V_L = 10 \text{ V}$
		Reverse (ON) time*	Typical	$T_{on}$	9.4 ms	$I_F = 0 \rightarrow 5 \text{ mA}$
			Maximum		15 ms	$I_L = 100 \text{ mA}$ $V_L = 10 \text{ V}$
	I/O capacitance	Typical	$C_{iso}$	0.8 pF	$f = 1 \text{ MHz}$	
		Maximum		1.5 pF	$V_B = 0$	
	Initial I/O isolation resistance	Minimum	$R_{iso}$	1,000 M $\Omega$	500 V DC	
	Maximum operating frequency	Maximum	—	0.5 cps	$I_F = 10 \text{ mA}$ Duty factor = 50% $I_L = \text{Max.}, V_L = \text{Max.}$	

Note: Recommendable LED forward current  $I_F = 5$  to 10 mA.

\*Operate/Reverse time

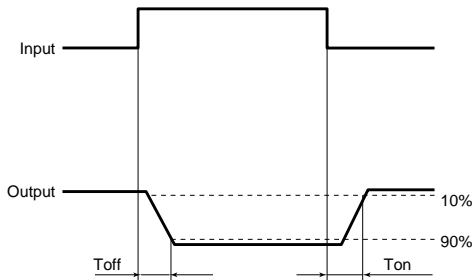

- For Dimensions, see Page 442.
- For Schematic and Wiring Diagrams, see Page 448.
- For Cautions for Use, see Page 453.

## REFERENCE DATA

### 1. Load current vs. ambient temperature characteristics

Allowable ambient temperature:  $-40^\circ\text{C}$  to  $+85^\circ\text{C}$   
 $-40^\circ\text{F}$  to  $+185^\circ\text{F}$

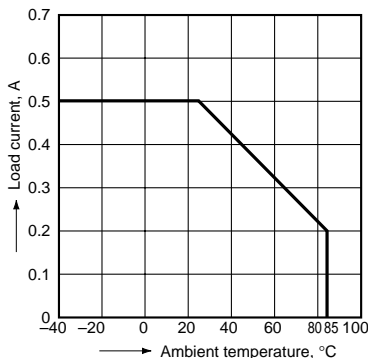

### 2. Load current vs. ambient temperature characteristics in adjacent mounting

$I_L$ : Load current;  
 $I_L(\text{max.})$ : Maximum continuous load current

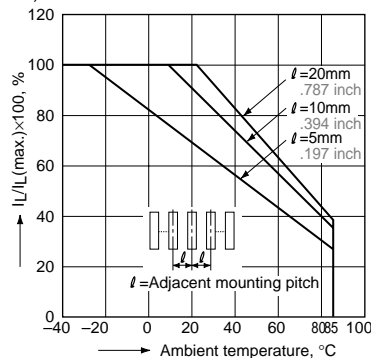

### 3. On resistance vs. ambient temperature characteristics

LED current: 0 mA; Load voltage: Max. (DC)  
Continuous load current: Max. (DC)

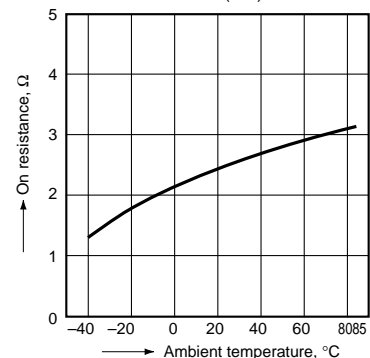

4. Operate (OFF) time vs. ambient temperature characteristics

LED current: 10 mA; Load voltage: 10 V (DC); Continuous load current: 100 mA (DC)

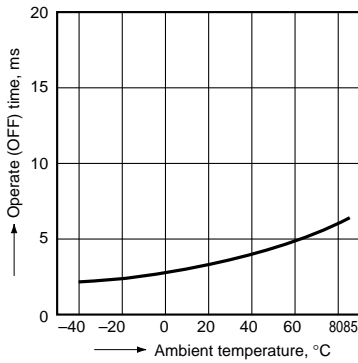

5. Reverse (ON) time vs. ambient temperature characteristics

LED current: 10 mA; Load voltage: 10 V (DC); Continuous load current: 100 mA (DC)

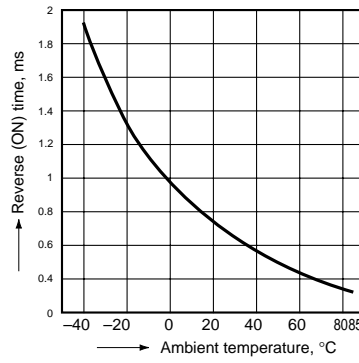

6. LED operate (OFF) current vs. ambient temperature characteristics

Load voltage: 10 V (DC); Continuous load current: 100 mA (DC)

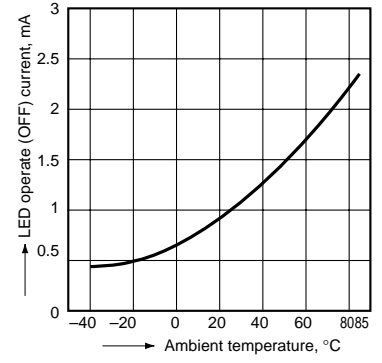

7. LED reverse (ON) current vs. ambient temperature characteristics

Load voltage: 10 V (DC); Continuous load current: 100 mA (DC)

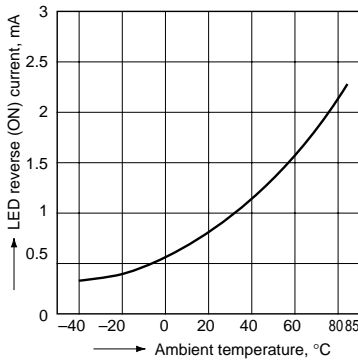

8. LED dropout voltage vs. ambient temperature characteristics

Sample: all types; LED current: 5 to 50 mA

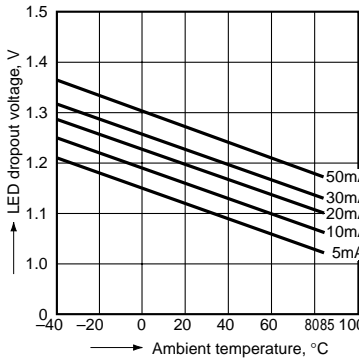

9. Voltage vs. current characteristics of output at MOS portion

Ambient temperature: 25°C 77°F

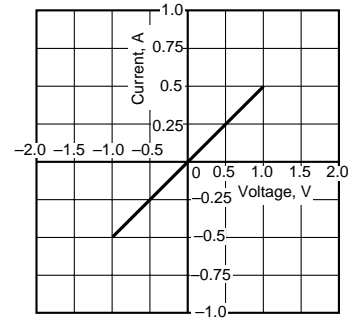

10. Off state leakage current

Ambient temperature: 25°C 77°F

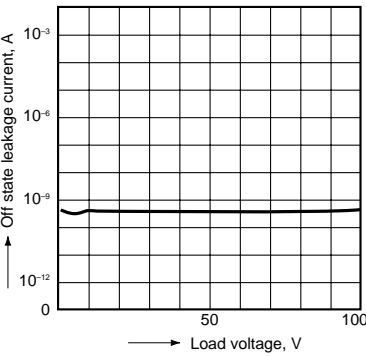

11. LED forward current vs. operate (OFF) time characteristics

Load voltage: 10 V (DC); Continuous load current: 100 mA (DC); Ambient temperature: 25°C 77°F

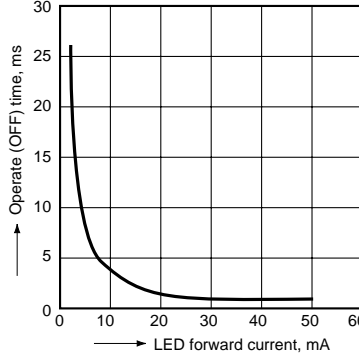

12. LED forward current vs. reverse (ON) time characteristics

Load voltage: 10 V (DC); Continuous load current: 100 mA (DC); Ambient temperature: 25°C 77°F

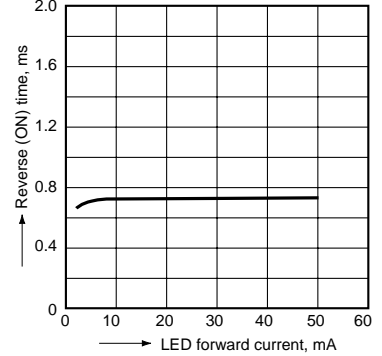

13. Maximum operating frequency vs. load voltage/current characteristics

LED current: 10 mA; Ambient temperature: 25°C 77°F

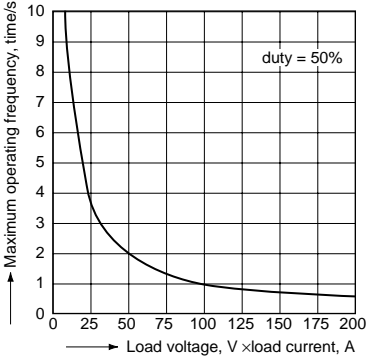

14. Applied voltage vs. output capacitance characteristics

Frequency: 1 MHz; Ambient temperature: 25°C 77°F

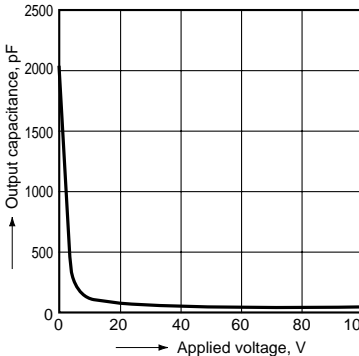

# AQZ404

## ACCESSORY

mm inch

### Socket



#### Standard type

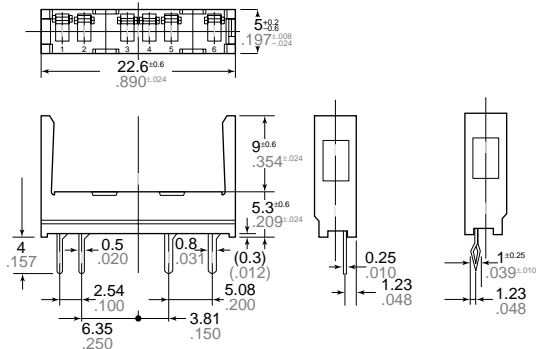

PA1a-PS

General Tolerance:  $\pm 0.3 \pm 0.012$

#### Self clinching type

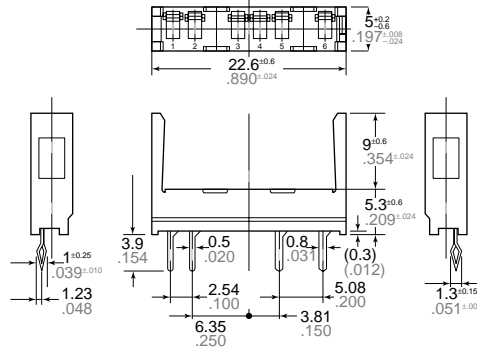

PA1a-PS-H

General Tolerance:  $\pm 0.3 \pm 0.012$

#### PC board pattern (BOTTOM VIEW) Standard type

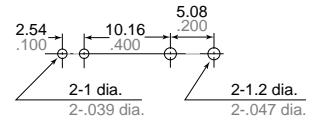

#### Self clinching type

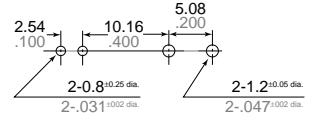

Tolerance:  $\pm 0.1 \pm 0.004$