

TOSHIBA Bipolar Linear Integrated Circuit Silicon Monolithic

# TA1276AFG

## PAL/NTSC Video Chroma And Deflection IC For CTV (normal scan/double scan mode)

TA1276AFG provides Video, Chroma and Deflection (sync, when double scan mode) circuit for a PAL/NTSC Color TV, and suitable for a high picture quality, large screen size, wide and/or double scanning TV. These functions are integrated in a 80 pin QFP plastic package.

TA1276AFG provides a high-performance video processor in which a YUV double scanning signal can be applied in Video, PAL/NTSC auto-detection circuit in Chroma and 50/60 Hz auto-detection circuit in Sync. PAL demodulation circuit includes Baseband signal processing system. And this demodulation circuit does not required any adjustment.

TA1276AFG includes I<sup>2</sup>C bus interface, so you can adjust various functions and controls via the bus.

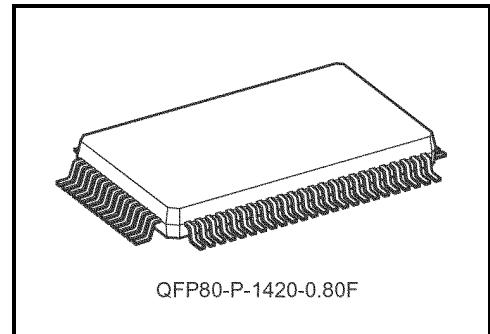

Weight: 1.6 g (typ.)

### Features

- Video/chroma section
  - Y delay line
  - Chroma trap
  - IQ demodulation for NTSC, UV demodulation for PAL
- BEP (back end processor) section
  - Enable to process a YUV signal independently
  - Double scanning signal processing capability
- (Y processing section)
  - Black stretcher (controlled by I<sup>2</sup>C bus)
  - DC restoration circuit (controlled by I<sup>2</sup>C bus)
  - Highbright-color circuit
  - D.L. aperture sharpness circuit + super real transcend circuit (LTI)
  - $\gamma$  correction (enable to control binary line, gain/start point)
  - Y noise reduction circuit
  - Velocity scan modulation output (the first order differential output and phase/amplitude adjustment)
- (color difference section)
  - Color detail enhancer
  - Selectable relative phase and amplitude
  - Flesh-color restoration
  - Color  $\gamma$  circuit
  - Baseband tint color
- (text section)
  - RGB primary color output
  - On screen display interface
  - Linear RGB interface
  - Fast blanking
  - Drive control
  - AKB (only black level) or cut-off bus control
  - Deflection section
- High performance sync. separation circuit
- Adjustment free H and V oscillation circuit by countdown system
- Horizontal and vertical position adjustment
- Sync separation, HD output
- Horizontal and vertical pulse output in normal mode.

Pin Assignment

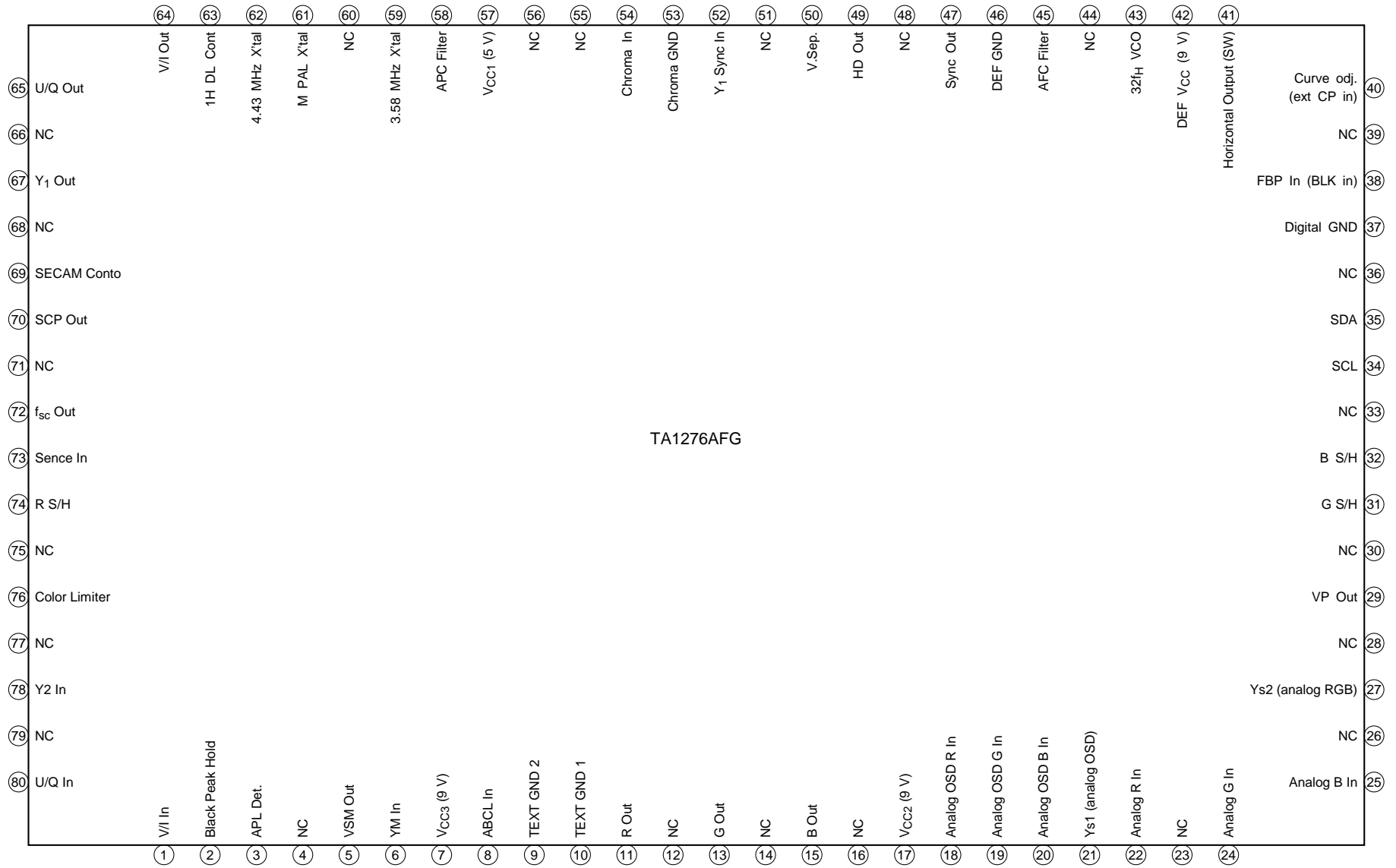

TA1276AFG

Block Diagram

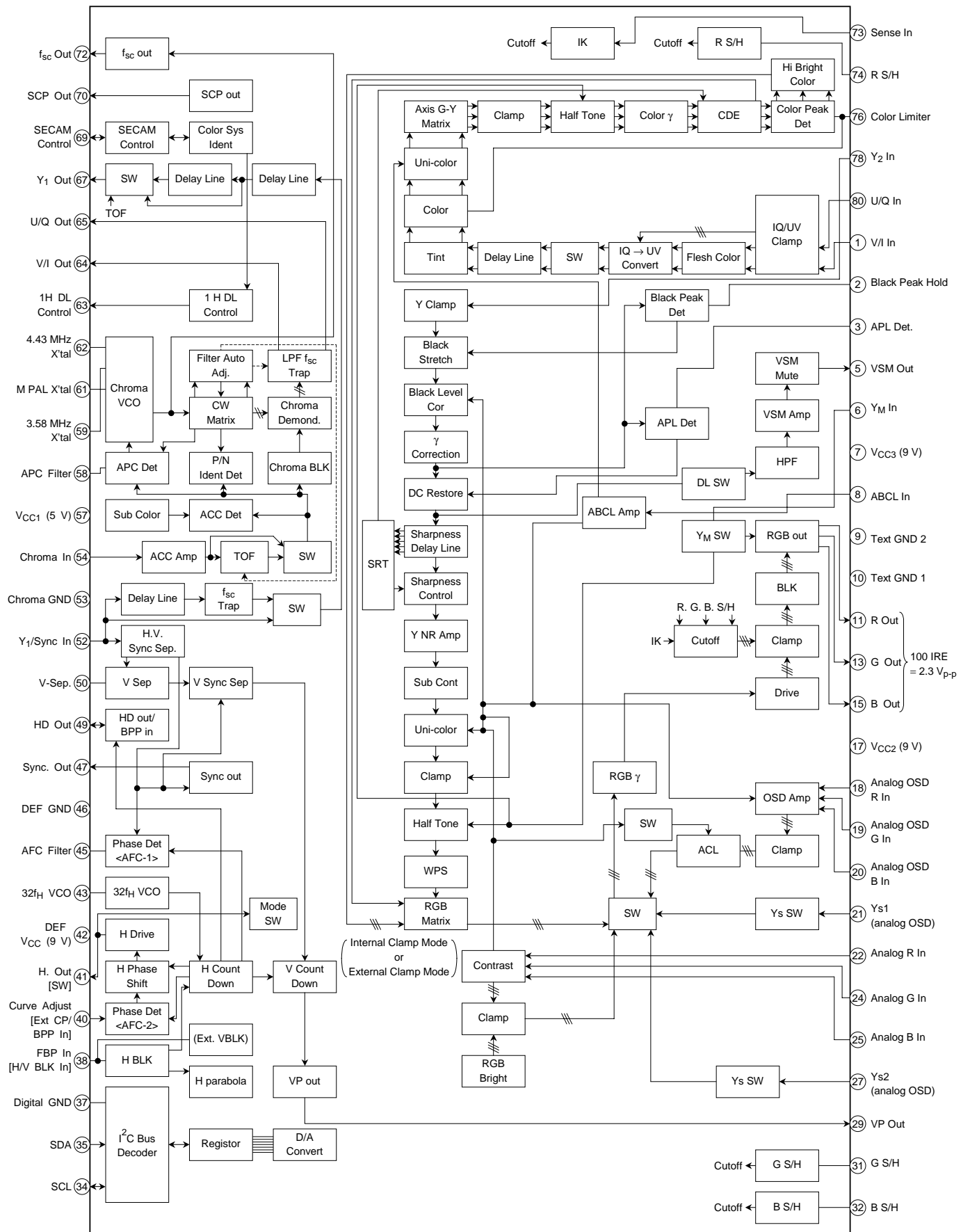

• Pin 41 connect to  $V_{CC}$ : Double Scan mode

Note 1: [ ]: for Double Scan mode only (external clamping pulse input mode)

## Terminal Functions

Pin No.	Pin Name	Function	Interface Circuit	Input/Output Signal
1 80	V/I input U/Q input	The pin through which R-Y (V)/I and B-Y (U)/Q signals are input. Input via clamp capacitor.		When Burst: Chroma = 1:1 360 mV <sub>p-p</sub> DC: 5.0 V
2	Black peak hold	Connect the filter controlling the black stretching gain of the black stretching circuit. The black stretching gain varies depending on the voltage at this pin.		DC
3	APL detection	Connect the filter correcting DC restoration ratio. Opening this pin can monitor the Y-signal that was subjected to black stretching.		DC
4	NC	None connect PIN. These pins connect to GND.	—	—
5	VSM output	Outputs the Y-signal that routed HPF after it had been subjected to DC restoration. The output is muted with the switches of pins 32 and 36.		DC 3.5 V

Pin No.	Pin Name	Function	Interface Circuit	Input/Output Signal
6	YM input	The half-tone switch for internal RGB signal. When the voltage at this pin is set to 7.0 V or more, the RGB output voltage.		<p>Soft AKB — 7.0 V</p> <p>Half Tone — 0.75 V</p> <p>TV — GND</p>
7	V <sub>CC3</sub> (9 V)	The V <sub>CC</sub> pin of picture quality and color difference blocks. Connect 9 V (typ.).	—	—
8	ABCL input	Used to control the external uni-color, brightness, and dynamic ABL. Use this pin when using ABL or ACL. The sensitivity and starting point of the ABL and dynamic ABL can be set by using bus.		<p>ABCL OFF: 6 V or more</p>
9	TEXT GND 2	The GND pin of TEXT block.	—	—
10	TEXT GND 1	The GND pin of TEXT block.	—	—
11 13 15	R output G output B output	Outputs RGB.		<p>100 IRE: 2.3 V<sub>p-p</sub></p> <p>2.5 V</p> <p>GND</p> <p>At Cont max BRT Cent.</p>
12	NC	None connect PIN. These pins connect to GND.	—	—
14	NC	None connect PIN. These pins connect to GND.	—	—
16	NC	None connect PIN. These pins connect to GND.	—	—
17	V <sub>CC2</sub> (9 V)	The V <sub>CC</sub> pin of the text block. Connect 9 V (typ.).	—	—

Pin No.	Pin Name	Function	Interface Circuit	Input/Output Signal
18 19 20	Analog OSD R input Analog OSD G input Analog OSD B input	<p>The pin through which the OSD signal or analog RGB is input.</p> <p>(1) When inputting an OSD signal, input the ODS signal with a voltage of 0 to 5 V (4.1 V or more).</p> <p>(2) When inputting an analog RGB, input the RGB signal via clamp capacitor. ACL works on this input signal only when the entire screen is YS1-HI (the entire screen: OSD).</p>		<p>(1) </p> <p>(2) </p>
21	YS1	Switches between the internal RGB signal and OSD/analog RGB (pin 18, 19, 20). When this switch is on, the VSM output is muted.		<p>OSD 2.25 V</p> <p>VSM Mute 0.75 V</p> <p>TV GND</p>
22 24 25	Analog R input Analog G input Analog B input	The pin through which the analog RGB is input. Input the RGB signal via clamp capacitor.		<p>100 IRE: 0.5 V<sub>p-p</sub></p> <p></p>
23	NC	None connect PIN. These pins connect to GND.	—	—
26	NC	None connect PIN. These pins connect to GND.	—	—
27	YS2	Switches between the internal RGB signal and analog RGB (pin 33, 34, 35) signal. When this switch is on, the VSM output is muted.		<p>A. BGB 0.75 V</p> <p>TV GND</p>
28	NC	None connect PIN. These pins connect to GND.	—	—

Pin No.	Pin Name	Function	Interface Circuit	Input/Output Signal
29	VP output	Outputs the vertical pulse. This pin also serves as the external blanking input. When current stronger than 350 $\mu$ A flows, blanking takes place due to the internal blanking and OR logic circuit.		
30	NC	None connect PIN. These pins connect to GND.	—	—
31 32	G S/H B S/H	These pins are to be connected with a capacitor for sampling and holding a bias voltage in the AKB operation, or for clamping to set DC voltage of RGB outputs in the no-AKB mode.		DC
33	NC	None connect PIN. These pins connect to GND.	—	—
34	SCL	The SCL pin of I <sup>2</sup> C bus.		—
35	SDA	The SDA pin of I <sup>2</sup> C bus.		—
36	NC	None connect PIN. These pins connect to GND.	—	—

Pin No.	Pin Name	Function	Interface Circuit	Input/Output Signal
37	Digital GND	The GND pin of I <sup>2</sup> L block.	—	—
38	FBP input	The pin through which FBP is input to generate pulses for horizontal AFC2, Y smoothing, and horizontal blanking. When double SCAM mode, input H blanking pulse (5 V or over).		
39	NC	None connect PIN. These pins connect to GND.	—	—
40	Curve correction (ext. CP/BPP input)	<p>(1) Used to correct distortion of picture in the case of high-tension fluctuation. Input the AC component of high-tension fluctuation. To deactivate the distortion correction feature, connect a capacitor of 0.01 μF between this pin and GND.</p> <p>(2) Double scan mode This pin is to input external CP (clamping pulse) and BPP (black peak detection stopping pulse).</p>		<p>(1) DC 4.5 V (2)</p>
41	Horizontal output (mode SW)	Produces the horizontal output. Connecting the DEF V <sub>CC</sub> to this pin can switch Double Scan mode. In this case, the horizontal output is not produced.		<p>HIGH: 3.2 V LOW: 0.2 V</p>
42	DEF V <sub>CC</sub> (9 V)	The V <sub>CC</sub> of DEF block. Connect 9 V (typ.) to this pin.	—	—



Pin No.	Pin Name	Function	Interface Circuit	Input/Output Signal
43	32f <sub>H</sub> VCO	Connect the ceramic oscillator for horizontal oscillation. The oscillator to be used is CSBLA503KECZF30, made by Murata electronics.		
44	NC	None connect PIN. These pins connect to GND.	—	—
45	AFC filter	Connect the filter for horizontal AFC. The frequency of the horizontal output varies depending on the voltage at this pin.		DC
46	DEF GND	The GND pin of DEF block.	—	—
47	SYNC. output	Output the synchronizing signal that was separated in the synchronous separation circuit. This pin is of the open collector system. Connect the pull-up resistor.		
48	NC	None connect PIN. These pins connect to GND.	—	—
49	HD output	(1) When BUS HD-OUT = 0 Output the HD pulse (pulse duration: 1 μs) together with AFC. This pin also serves as the external input pin that accepts BPP (black peak detection stopping pulse) signal.  (2) When BUS HD-OUT = 1 When AKB mode is ON, the pulse which covers AKB reference period is output.		

Pin No.	Pin Name	Function	Interface Circuit	Input/Output Signal
50	V-Sep.	Connect the filter separating the vertical synchronization.		DC6.4 V
51	NC	None connect PIN. These pins connect to GND.	—	—
52	Y <sub>1</sub> /SYNC input	The pin through which the composite video signal or Y signal is input. Input via clamp capacitor.		
53	Chroma GND	The GND pin of the chroma processing block.	—	—
54	Chroma input	The pin through which the chroma is input. Input the chroma signal that was subjected to Y/C separation.		
55	NC	None connect PIN. These pins connect to GND.	—	—
56	NC	None connect PIN. These pins connect to GND.	—	—
57	V <sub>CC1</sub> (5 V)	The V <sub>CC</sub> of the chroma and I <sup>2</sup> C Bus blocks. Connect 5 V (typ.)	—	—

Pin No.	Pin Name	Function	Interface Circuit	Input/Output Signal
58	APC filter	Connect APC filter demodulating the chroma. The oscillation frequency of VCXO varies depending on the voltage at this pin.		DC
60	NC	None connect PIN. These pins connect to GND.	—	—
62 61 59	4.43 MHz X'tal M PAL X'tal 3.58 MHz X'tal	Connect X'tal. In the case of series capacity, the oscillation frequency ( $f_0$ ) can be changed. In the case of parallel capacity, the changeable range of frequency can be changed.	<p>R Pin 62 1.5 kΩ Pin 61 2.5 kΩ Pin 59 2.5 kΩ</p>	DC 4.0 V 90 mV <sub>p-p</sub>
63	1H DL control	Outputs the result of whether the signal is PAL, SECAM or NTSC. Connect the output to the 1H DL IC. In the case of discrimination between white or black, the voltage just before that is retained. The voltage immediately after turning-on is not fixed.		8.4 V: PAL 4.3 V: SECAM 0 V: NTSC
64	V/I output	Outputs R-Y (V) or Q signal. It includes LPF that can remove carrier. The chroma signal that routed ACC and TOF circuits (before demo input) can be monitored by pulling up this pin at 10 kΩ.		DC 2.5 V Rainbow color bar : 360 mV <sub>p-p</sub>

Pin No.	Pin Name	Function	Interface Circuit	Input/Output Signal
65	U/Q output	Outputs B-Y (U) or I signal. It includes LPF that can remove carrier.		DC 2.5 V  Rainbow color bar : 360 mV <sub>p-p</sub>
66	NC	None connect PIN. These pins connect to GND.	—	—
67	Y <sub>1</sub> output	Outputs the Y signal that routed the f <sub>sc</sub> TRAP (TRAP can be turned on or off with bus.) and the Y delay line circuit.		
68	NC	None connect PIN. These pins connect to GND.	—	—
69	SECAM control	The input/output pin that is used to control the SECAM demodulation IC. When current stronger than 250 μA flows from this pin, that is recognized as SECAM.		When PAL/NTSC 4.0 V  When SECAM 0.75 V
70	SCP output	Outputs SCP (sand castle pulse). The output signal consists of clamp pulse, horizontal blanking pulse, and vertical blanking. The minimum load resistance is 3 kΩ.		
71	NC	None connect PIN. These pins connect to GND.	—	—

Pin No.	Pin Name	Function	Interface Circuit	Input/Output Signal
72	f <sub>sc</sub> output	Outputs oscillation waveform of VCXO. When 3.58 NTSC killer-off this pin voltage sets 3.2 V. When B/W or other systems killer-off, this pin voltage sets 1.4 V.		DC 3.58 NTSC : 3.2 V B/W or Others system : 1.4 V  AC 0.6 V <sub>p-p</sub>
73	SENSE input	This pin is to sense IK voltage feed-back from a CRT Drive circuit.		
74	R S/H	The same as pin 31 and 32.	The same as pin 31 and 32.	DC
75	NC	None connect PIN. These pins connect to GND.	—	—
76	Color limiter	Color the filter detecting the color limit.		DC
77	NC	None connect PIN. These pins connect to GND.	—	—
78	Y <sub>2</sub> input	The pin through which B-Y (V)/I and R-Y (U)/Q signals are input. Input via clamp capacitor.		1 V <sub>p-p</sub> (both signals) 6.3 V GND
79	NC	None connect PIN. These pins connect to GND.	—	—

## Bus Control Map

### Write Mode

Slave Address: 88H (10001000)

Sub Address	D7 MSB	D6	D5	D4	D3	D2	D1	D0 LSB	Preset	
									MSB	LSB
00	P-MUTE	UNI-COLOR							1000	0000
01	BRIGHTNESS								1000	0000
02	COLOR							Y-MUTE	1000	0000
03	TINT							YM-SW	1000	0000
04	SHARPNESS							YNR	1000	0000
05	RGB BRIGHTNESS							WPS L	1000	0000
06	HI BRT	RGB CONTRAST							1000	0000
07	SUB COLOR					COLOR $\gamma$		CLT	1000	0000
08	SUB CONTRAST					Y- $\gamma$ CURVE		FLESH	1000	0000
09	G (R) DRIVE							DR-SW	1000	0000
0A	B DRIVE							CDE	1000	0000
0B	HORIZONTAL POSITION					HV-SepL	V-OFF	H-BLK	1000	0000
0C	R CUT OFF								1000	0000
0D	G CUT OFF								1000	0000
0E	B CUT OFF								1000	0000
0F	R-Y PHASE		R/B GAIN		G/B GAIN		G-Y PHASE		0000	0000
10	COLOR SYSTEM			P/N-ID	BB SW	OSD-SL	OS-ACL	TX-ACL	0000	0000
11	VSM PHASE		VSM GAIN		APACON PEAK $f_0$			VSM-PB	0000	0000
12	DC RESTORATION POINT			DC RESTORATION RATE			DC REST. LIMIT		0000	0000
13	BLACK STRETCH POINT			APL VS BSP		Y- $\gamma$ PNT	VSM-H.PB FREQ		0000	0000
14	SHR-TRACKING		TEST	RGB- $\gamma$	B.L.C.	B.S.G.	B.D.L.	BS-ARE	0000	0000
15	DYNAMIC ABL POINT			DYNAMIC ABL GAIN			AKB MODE		0000	0000
16	ABL POINT			ABL GAIN			RGB OUT MODE		0000	0000
17	HD-OUT	V-BLK	VERTICAL FREQUENCY			VERTICAL POSITION			0000	0000
18	Y-DL	C-TRAP	TOF $f_0$			TOF-Q			0000	0000

## Read Mode

Slave Address: 89H (10001001)

	D7	D6	D5	D4	D3	D2	D1	D0
0	PORSET	COLOR SYSTEM		X'tal		V-FREQ	V-STD	H-LOCK
1	N-DET	RGBOUT	Y <sub>1</sub> -IN	IQ-IN	Y <sub>2</sub> -IN	H-OUT	VP-OUT	IK-IN

## Bus Control Feature Write Mode

Item	Explain	Preset
P-MUTE	Picture mute SW; (0): OFF, (1): ON	ON
UNI-COLOR	Uni-color adjustment; -18dB to 0dB	Center
BRIGHTNESS	Brightness adjustment (including sub adjustment); -40 IRE to +40 IRE	Center
COLOR	Color adjustment; -20dB (color mute) to +4dB	0dB
Y-MUTE	Y mute SW; (0): ON, (1): OFF	ON
TINT	Hue adjustment; -32° to +32°	0°
TM-SW	Half-tone SW (YUV input); (0): OFF, (1): ON	OFF
SHARPNESS	Sharpness adjustment; -20dB to +14dB	+8dB
YNR	Y Noise Reduction SW; (0): OFF, (1): ON	OFF
RGB BRIGHTNESS	RGB Brightness Adjustment; -20 IRE to +20 IRE	0 IRE
WPS L	White Peak Suppression Level; (0): 130 IRE, (1): 110 IRE	130 IRE
HI BRT	High-bright color; (0): OFF, (1): ON	OFF
RGB CONTRAST	RGB Contrast; -18dB to 0dB	-18dB
SUB COLOR	Sub-color; -4dB to 0dB to +3dB	0dB
COLOR $\gamma$	Color $\gamma$ correction point; (00): OFF, (01): 0.2 V <sub>p-p</sub> , (10): 0.4 V <sub>p-p</sub> , (11): 0.6 V <sub>p-p</sub>	OFF
CLT	Color Limiter Level; (0): 1.8 V <sub>p-p</sub> , (11): 2.2 V <sub>p-p</sub>	1.8 V <sub>p-p</sub>
SUB CONTRAST	Sub-contrast adjustment; -3dB to +3dB	0dB
Y- $\gamma$ CURVE	Y- $\gamma$ curve switching; (00): OFF, (01): -2.5dB, (10): -5.6dB, (11): -7dB	OFF
FLESH	Flesh color; (0): OFF, (1): ON	OFF
G (R)/B DRIVE	R (G)/B drive gain adjustment; -5dB to 0dB to +3dB	0dB (40h)
DG-SW	Drive gain base axis switching; (0): G, (1): R	G
CDE	Color Detail Enhancer; (0): ON (foced OFF when sharpness go through), (1): OFF	ON
HORIZONTAL POSITION	Horizontal position adjustment; -3 $\mu$ s to +3 $\mu$ s	0 $\mu$ s
HV-SepL	Sync separation level; (from SYNC TIP) (0): 35%, (1): 40%	35%
V-OFF	Vertical output SW; (0): ON, (1): OFF	ON
H-BLK	Horizontal blanking SW; (0): ON, (1): OFF	ON
R/G/B CUTOFF	R/G/B cut-off adjustment; • When AKB-OFF: RGB output 2 V to 2.5 V to 3 V • When AKB-ON: SENS input 1 V <sub>p-p</sub> to 1.5 V <sub>p-p</sub> to 2 V <sub>p-p</sub> ( $\pm$ 5 IRE)	Center (80h)
R-Y PHASE	R-Y relative phase switching; (00): 90°, (01): 92°, (10): 94°, (11): 112°	90°
R/B GAIN	R/B relative amplitude switching; (00): 0.56, (01): 0.68, (10): 0.79, (11): 0.86	0.56
G/B GAIN	G/B relative amplitude switching; (00): 0.3, (01): 0.34, (10): 0.4, (11): 0.45	0.3
G-Y PHASE	G-Y relative phase switching; (00): 236°, (01): 240°, (10): 244°, (11): 253°	236°

Item	Explain	Preset																																													
COLOR SYSTEM	Color system; <table border="1"> <thead> <tr> <th>System</th> <th>X'tal</th> <th>Color difference mute</th> <th>Color difference input</th> <th>TINI control</th> </tr> </thead> <tbody> <tr> <td>(000): NTSC</td> <td>3.58</td> <td>Forced OFF</td> <td>I/Q</td> <td>Enable</td> </tr> <tr> <td>(001): NTSC</td> <td>3.58</td> <td>Forced OFF</td> <td>U/V</td> <td>Enable</td> </tr> <tr> <td>(010): NTSC</td> <td>4.43</td> <td>Forced OFF</td> <td>U/V</td> <td>Enable</td> </tr> <tr> <td>(011): PAL</td> <td>4.43 (N)</td> <td>Forced OFF</td> <td>U/V</td> <td>Enable</td> </tr> <tr> <td>(100): PAL</td> <td>M</td> <td>Forced OFF</td> <td>U/V</td> <td>Enable</td> </tr> <tr> <td>(101): SECAM</td> <td>4.43</td> <td>Forced OFF</td> <td>U/V</td> <td>Enable</td> </tr> <tr> <td>(110): MULTI</td> <td>3.58/4.43</td> <td>Forced OFF</td> <td>U/V</td> <td>Enable</td> </tr> <tr> <td>(111): Trinorma</td> <td>3.58/M/N</td> <td>Forced OFF</td> <td>U/V</td> <td>Enable</td> </tr> </tbody> </table>	System	X'tal	Color difference mute	Color difference input	TINI control	(000): NTSC	3.58	Forced OFF	I/Q	Enable	(001): NTSC	3.58	Forced OFF	U/V	Enable	(010): NTSC	4.43	Forced OFF	U/V	Enable	(011): PAL	4.43 (N)	Forced OFF	U/V	Enable	(100): PAL	M	Forced OFF	U/V	Enable	(101): SECAM	4.43	Forced OFF	U/V	Enable	(110): MULTI	3.58/4.43	Forced OFF	U/V	Enable	(111): Trinorma	3.58/M/N	Forced OFF	U/V	Enable	NTSC (000)
System	X'tal	Color difference mute	Color difference input	TINI control																																											
(000): NTSC	3.58	Forced OFF	I/Q	Enable																																											
(001): NTSC	3.58	Forced OFF	U/V	Enable																																											
(010): NTSC	4.43	Forced OFF	U/V	Enable																																											
(011): PAL	4.43 (N)	Forced OFF	U/V	Enable																																											
(100): PAL	M	Forced OFF	U/V	Enable																																											
(101): SECAM	4.43	Forced OFF	U/V	Enable																																											
(110): MULTI	3.58/4.43	Forced OFF	U/V	Enable																																											
(111): Trinorma	3.58/M/N	Forced OFF	U/V	Enable																																											
P/N ID	PAL/NTSC ident sensitivity switching; (0): LOW (when digital comb filter used), (1): Normal	LOW																																													
BB SW	Blue Back SW; (0): OFF, (1): ON	OFF																																													
OSD-SL	OSD peak suppressing level switching; (0): 96 IRE, (1): 76 IRE	96 IRE																																													
OS-ACL	OSD ACL SW; (0): ON, (1): OFF	ON																																													
TX-ACL	RGB ACL SW; (0): Gain 1/2, (1): Normal	Gain1/2																																													
VSM PHASE	VSM output phase switching; (00): -40 ns, (01): -20 ns, (10): 0 ns, (11) +20 ns	-40 ns																																													
VSM GAIN	VSM output gain switching; (00): 0dB, (01): -6dB, (10): -9dB, (11): OFF	0dB																																													
APACON PEAK $f_0$	Apacon peak frequency switching; (000): Through (apacon off), (001): 4.0 MHz, (010): 3.3 MHz, (011): 2.5 MHz, (100): Through (apacon off), (101): 13 MHz, (110): 10 MHz, (111): 8 MHz	(000) Through																																													
VSM PB	VSM output horizontal parabolic modulation SW; (0): Parabolic modulation OFF, (1): ON (nearby sharpness -3dB)	Parabolic modulation OFF																																													
DC RESTORATION POINT	DC restoration start point; (000): 0% to (111): 42%	0%																																													
DC RESTORATION RATE	DC restoration rate; (000): 100% to (111): 130%	100%																																													
DC REST. LIMIT	DC restoration limit point; (APL) (00): 100%, (01): 87%, (10): 73%, (11): 60%	100%																																													
BLACK STRETCH POINT (BSP)	Black stretcher start point; When APL 0% (000): 22 IRE to (111): 56 IRE	22 IRE																																													
APL VS BSP (AVS)	APL level vs. black stretcher start point; (00): 0dB to (11): 1.5dB, BSP + APL $\times$ BSP $\times$ AVS	0dB																																													
Y- $\gamma$ PNT	Y- $\gamma$ point switching; (0): 100 IRE, (1): 95 IRE	100 IRE																																													
VSM-H. PB FREQ	VSM output horizontal parabolic frequency; (00): 15.7 kHz, (01): 24.8 kHz, (10): 31.5 kHz, (11): 33.75 kHz	—																																													
SHR-TRACKING	Sharpness tracking; (00): HIGH, (11): LOW	HIGH																																													
TEST	Test mode; (0): NORMAL (1): Test mode (for factory test) Switched by sub-address 17H <during gate-pulse> D <sub>2</sub> (0): during V-BLK, (1): NORMAL Y/RGB smoothing OFF, Monitor of DAC at HD output	NORMAL																																													
RGB- $\gamma$	RGB- $\gamma$ SW; (0): OFF, (1): ON	OFF																																													
B.L.C.	Block level automatic correction (priority over black stretcher); max 7.5 IRE (0): OFF, (1): ON	OFF																																													
B.S.G.	Black stretcher gain SW; (0) ON, (1): OFF	ON																																													
B.D.L.	Black detection SW; (0): 3 IRE, (1): 0 IRE	3 IRE																																													
BS-ARE	Black area reinforcement SW; For wide TV (when using time axis compression IC) (0): ON, (1): OFF	ON																																													
DYNAMIC ABL POINT	Dynamic ABL detection voltage; (000): min to (111): max	min																																													



Item	Explain	Preset
DYNAMIC ABL GAIN	Dynamic ABL sensitivity; (000): min to (111): max	min
AKB MODE	AKB MODE; Only black level (00): AKB OFF + S/H LOW, (01): AKB OFF + Cutoff BUS (10): AKB ON + I-DET NORMAL, (11): AKB ON + I-DET × 3	(00) AKB OFF + S/H LOW
ABL POINT	ABL detect voltage; (000): min to (111): max	min
ABL GAIN	ABL GAIN; (000): min to (111): max	min
RGB OUT MODE	RGB output mode SW; (00): NORMAL, (01): Only R, (10): Only G, (11): Only B	NORMAL
HD-OUT	HD output SW; (0): HD output, (1): AKB period pulse	HD output
V-BLK	Vertical Blanking SW; (0): ON, (1): OFF	ON
VERTICAL FREQUENCY	Vertical Frequency; (000): AUTO (50, 60 Hz), (001): AUTO (50, 60 Hz/V MASK OFF), (010): 60 Hz, (011): 60 Hz (V MASK OFF), (100): Forced 262.5H, (101): Forced 263H, (110): Forced 312.5H, (111): Forced 313H, When (100), (101), (110), (111): AFC Free-run	(000) AUTO
VERTICAL POSITION	Vertical position; (000): 0H to (111): 7H (1H STEP)	0H
Y-DL	Y-DL SW; (0) OFF, (1): ON (+80 ns)	OFF
C-TRAP	Chroma Trap SW; (0): OFF, (1): ON	OFF
TOF-f <sub>0</sub>	Selectable TOF Peak Frequency; (000): 0.8f <sub>sc</sub> + TOF OFF to (111): 1.5f <sub>sc</sub>	TOF OFF
TOF-Q	Selectable TOF Q; (000): 0.6 to (111): 1.2	0.6

## Delay Time From Y<sub>1</sub> Input (PIN 52) to Y<sub>1</sub> Output (PIN 67)

Color	Trap	Y-DL	Delay Time
B/W	—	OFF ON	295 ns 375 ns
PAL/NTSC	OFF	OFF	295 ns (4.43)
		ON	375 ns (4.43)
	ON	OFF	295 ns (3.58/M/N)
		ON	375 ns (3.58/M/N)
SECAM	—	OFF	295 ns (4.43)
		ON	310 ns (3.58/M/N)
		ON	375 ns (4.43)
		ON	390 ns (3.58/M/N)
SECAM	—	OFF	495 ns
		ON	575 ns

## Read Mode

Characteristic	Explain
PORSET	Power On Reset; (0): RESISTER PRESET, (1): NORMAL
COLOR SYSTEM	Color system; Receiving system (judgement of ID ON/OFF) (00): B/W, (01): SECAM, (10): PAL, (11): NTSC
X'tal	X'tal Mode; (00): —, (01): 4.43 (N), (10): M, (11): 3.58
V-FREQ	Vertical frequency; (0): 50 Hz, (1): 60 Hz
V-STD	Vertical Standard ident; (0) NON-STANDARD, (1): STANDARD
H-LOCK	Horizontal Lock ident; (0): LOCK, (1): UN-LOCK
N-DET	Noise ident result; (0): FEW, (1): MANY
RGBOUT, Y <sub>1</sub> -IN, IQ-IN, Y <sub>2</sub> -IN, H-OUT, VP-OUT	Self-ident result; (0): NG, (1): OK
IK IN	IK input ident result; (0): NG, (1): OK

## I<sup>2</sup>C Bus Transmission/Receiving

Slave Address: 88H

A <sub>6</sub>	A <sub>5</sub>	A <sub>4</sub>	A <sub>3</sub>	A <sub>2</sub>	A <sub>1</sub>	A <sub>0</sub>	W/R
1	0	0	0	1	0	0	0/1

### Start/Stop Condition

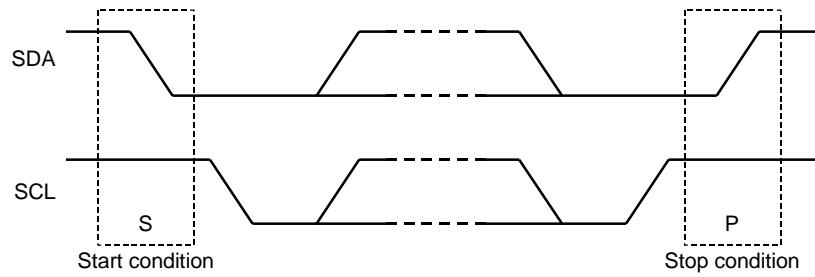

### Bit Transmission

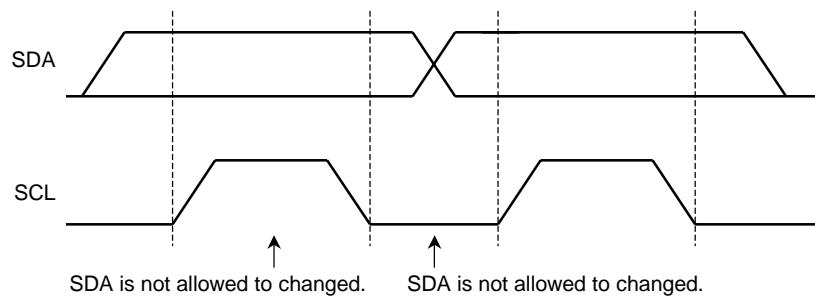

### Confirmation Response

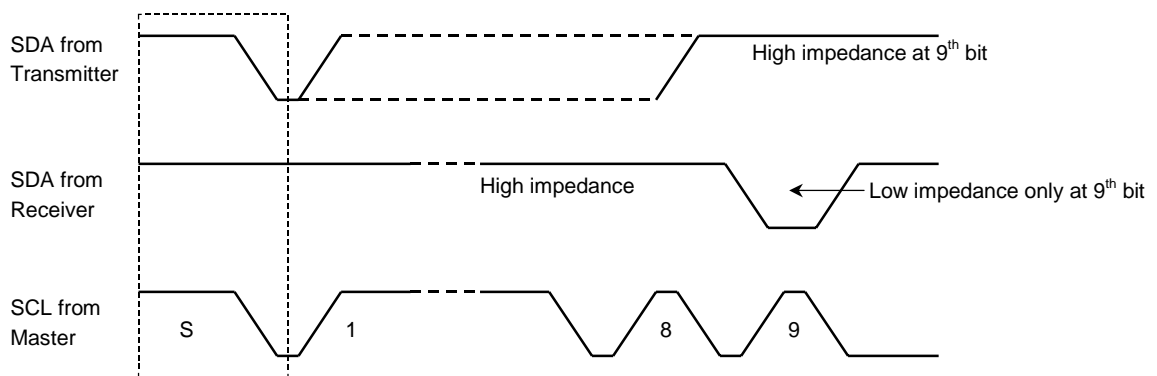

## Data Transmit Format 1

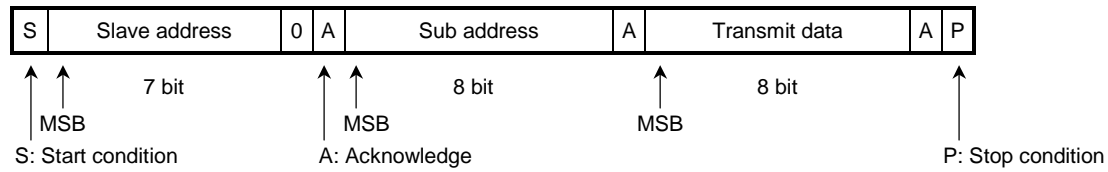

## Data Transmit Format 2

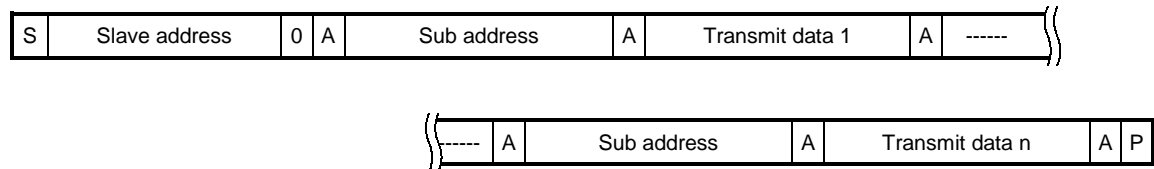

## Data Receive Format

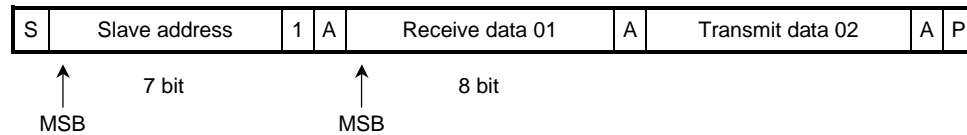

At the moment of the first acknowledge, the master transmitter becomes a master receiver and the slave receiver becomes a slave transmitter. This acknowledge is still generated by the slave.  
 The STOP condition is generated by the master.

## Optional Data Transmit Format: Automatic Increment Mode

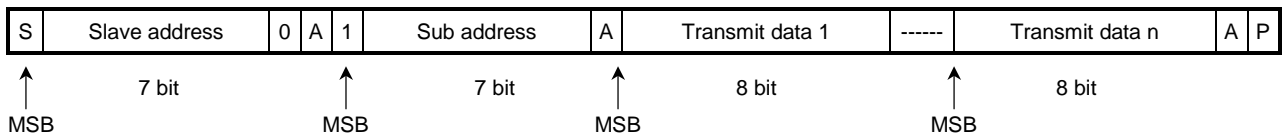

In this transmission method, data is set on automatically incremented sub-address from the specified sub-address.

Purchase of TOSHIBA I<sup>2</sup>C components conveys a license under the Phillips I<sup>2</sup>C Patent Rights to use these components in an I<sup>2</sup>C system, provided that the system conforms to the I<sup>2</sup>C standard Specification as defined by Phillips.

## Pin 41 H-out (mode SW)

You can select the Double Scan Mode (external CP (clamping pulse) input mode), by connecting Pin 41 to DEF VCC. (the threshold of pin 23:  $8.7\text{ V} = \text{DEF VCC} - 0.3\text{ V}$ )

When Double Scan Mode, function of Pin 38 and 40 are changed.

- Normal Scan (internal CP) Mode: Pin 41 — H-out  
The function of Pin 40 is curve correction input, that of Pin 38 is FBP (flay back pulse) input. The input signals of Y<sub>2</sub>, U/I and V/I inputs (pin 1, 2 and 3), Analog OSD inputs (pin 18, 19 and 20), Analog RGB inputs (pin 22, 24 and 25) are clamped of the internal CP based on the Y<sub>1</sub>/Sync input (pin 52).
- Double Scan (external CP input) Mode: Pin 41 — H-out  
The function of Pin 40 is EXT/BPP (Note 2) input, that of Pin 38 is H/V BLK (blanking) input. The input signals of Y<sub>2</sub>, U/I and V/I inputs (pin 1, 78 and 80), Analog OSD inputs (pin 18, 19 and 20), Analog RGB inputs (pin 22, 24 and 25) are clamped of the external CP based on Pin 40. In case of Double Scan Mode, bus “V-BLK” should be set (1); OFF.

## Terminal Functions

Pin No. \ Mode	Normal Scan Mode (internal CP)	Double Scan Mode (external CP input)
Pin 41	H-out	DEF V <sub>CC</sub> (9 V)
Pin 40	Curve correction signal input	EXT CP/BPP input
Pin 38	FBP input (for AFC-2 detection, H BKL)	H/V BLK input (for RGB H/V BLK, AKB)
Pin 1, 78, 80	Clamping by internal CP (based on pin 52)	Clamping by external CP (based on pin 40)
Pin 18, 19, 20		
Pin 22, 24, 25		
Pin 52	Normal scan; Y/Sync signal input	
Pin 49	Normal scan; HD pulse output (based on pin 52)	
Pin 29	Normal scan; VP output (based on pin 52)	

Note 2: BPP: Black Peak detection stopping Pulse

**Maximum Ratings (Ta = 25°C)**

Characteristics	Symbol	Rating	Unit
Supply voltage	V <sub>CCmax</sub>	12	V
Input terminal voltage	e <sub>inmax</sub>	9	V <sub>p-p</sub>
Power dissipation	P <sub>D</sub> (Note 3)	2500	mW
Power dissipation reduction rate	1/θ <sub>ja</sub>	20.0	mW/°C
Operating temperature	T <sub>opr</sub>	-20 to 70	°C
Storage temperature	T <sub>stg</sub>	-55 to 150	°C

Note 3: Refer to the figure below. (with device mounted on a PCB whose dimensions are 114.3 mm 76.2 mm × 1.6 mm and whose surface is 20% copper. mount the device on a PCB of at least these dimensions and whose surface is at least 20% copper.)

Note 4: Short pins 9 and 10 together on the PCB.

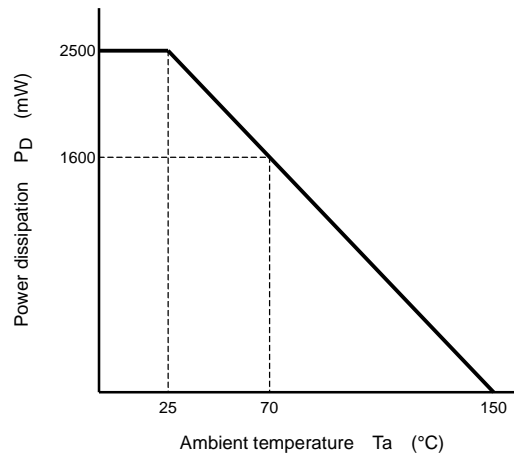

**Figure 1 Power Dissipation Reduction Against Higher Temperature**

## Recommended Condition In Use

Characteristic	Description	Min	Typ.	Max	Unit
Supply Voltage	Pin 65	4.3	5.0	5.3	V
	Pin 42, Pin 17, Pin 7	8.7	9.0	9.3	
Y <sub>1</sub> /Sync, Y <sub>2</sub> Input Signal Level	White: 100%, including, synchronization (synchronization: minus)	0.9	1.0	1.1	V <sub>p-p</sub>
Chroma Input Signal Level	When TOF OFF (burst level)	200	300	400	mV <sub>p-p</sub>
	When TOF ON (burst level)	100	200	300	
I/Q, U/V Input Level	B:C = 1:1	—	300	—	mV <sub>p-p</sub>
OSD/Analog RGB Input Level	When OSD input (DC coupling)	4.2	—	5.0	V
	When analog RGB input (AC coupling)	0.4	0.5	0.6	
Analog RGB Input Level	—	0.4	0.5	0.6	V <sub>p-p</sub>
FBP Width	—	11	12	13	μs
FBP Input Current	—	—	—	1.5	mA
RGB Output Current	—	—	1.0	2.0	
H. OUT Output Current	—	—	3.0	10.0	
Pin 47 Input Current	—	—	0.5	1.0	

## Electrical Characteristics

(V<sub>CC1</sub> = 5 V, V<sub>CC2</sub>/V<sub>CC3</sub>/DEF V<sub>CC</sub> = 9 V, Ta = 25°C, unless otherwise specified)

### Supply Current

Pin Name	Symbol	Test Circuit	Min	Typ.	Max	Unit
V <sub>CC1</sub>	I <sub>CC1</sub>	—	34.0	40.5	50.0	mA
V <sub>CC2</sub>	I <sub>CC2</sub>	—	33.0	40.0	49.0	
V <sub>CC3</sub>	I <sub>CC3</sub>	—	32.0	39.5	48.0	
DEF V <sub>CC</sub>	I <sub>CC4</sub>	—	9.5	12.8	18.0	

## Terminal Voltage

Pin No.	Pin Name	Symbol	Test Circuit	Min	Typ.	Max	Unit
1	V/I INPUT	V <sub>1</sub>	—	4.8	5.0	5.2	V
2	BLACK PEAK HOLD	V <sub>2</sub>	—	4.2	4.4	4.6	
3	APL DET	V <sub>3</sub>	—	4.8	5.0	5.2	
5	VM OUTPUT	V <sub>5</sub>	—	3.2	3.5	3.8	
8	ABCL INPUT	V <sub>8</sub>	—	5.85	6.10	6.35	
18	OSD/ANALOG R INPUT	V <sub>18</sub>	—	3.3	3.6	3.9	
19	OSD/ANALOG G INPUT	V <sub>19</sub>	—	3.3	3.6	3.9	
20	OSD/ANALOG B INPUT	V <sub>20</sub>	—	3.3	3.6	3.9	
21	Ys1	V <sub>21</sub>	—	0	0.1	0.3	
22	ANALOG R INPUT	V <sub>22</sub>	—	3.5	3.8	4.1	
24	ANALOG G INPUT	V <sub>24</sub>	—	3.5	3.8	4.1	
25	ANALOG B INPUT	V <sub>25</sub>	—	3.5	3.8	4.1	
27	Ys2	V <sub>27</sub>	—	0	0.1	0.3	
40	CURVE CORRECTION	V <sub>40</sub>	—	4.3	4.5	4.7	
43	32f <sub>H</sub> VCO	V <sub>43</sub>	—	5.4	5.7	6.0	
49	SYNC. IN	V <sub>49</sub>	—	2.60	2.85	3.10	
50	V SEP.	V <sub>50</sub>	—	5.7	6.1	6.5	
52	Y <sub>1</sub> INPUT	V <sub>52</sub>	—	2.7	3.0	3.3	
54	CHROMA INPUT	V <sub>54</sub>	—	2.2	2.5	2.8	
59	3.58 MHz X'tal	V <sub>59</sub>	—	3.7	4.0	4.3	
61	M PAL X'tal	V <sub>61</sub>	—	3.7	4.0	4.3	
62	4.43 MHz X'tal	V <sub>62</sub>	—	3.7	4.0	4.3	
64	V/I OUTPUT	V <sub>64</sub>	—	2.2	2.5	2.8	
65	U/Q OUTPUT	V <sub>65</sub>	—	2.2	2.5	2.8	
67	Y <sub>1</sub> OUTPUT	V <sub>67</sub>	—	1.7	2.0	2.3	
69	SECAM CONT.	V <sub>69</sub>	—	3.7	4.0	4.3	
76	COLOR LIMITER	V <sub>76</sub>	—	6.6	6.9	7.2	
78	Y <sub>2</sub> INPUT	V <sub>78</sub>	—	6.1	6.3	6.5	
80	U/Q INPUT	V <sub>80</sub>	—	4.8	5.0	5.2	



## AC Characteristic Video Section

Characteristics	Symbol	Test Circuit	Test Condition	Min	Typ.	Max	Unit
Y <sub>2</sub> input dynamic range	DR <sub>53</sub>	—	—	0.7	1.0	1.5	V <sub>p-p</sub>
Black level shift	V <sub>B</sub>	—	(Note V <sub>1</sub> )	-5	0	5	mV
	V <sub>B3</sub>	—		35	42	49	
Black stretching amplifier maximum gain	G <sub>BS</sub>	—	(Note V <sub>2</sub> )	1.30	1.40	1.50	times
Black stretching start point (1)	P <sub>BST1</sub>	—	(Note V <sub>3</sub> )	17	22	27	IRE
	P <sub>BST2</sub>	—		51	56	61	
Black stretching start point (2)	P <sub>BS1</sub>	—	(Note V <sub>4</sub> )	—	0	4	IRE
	P <sub>BS2</sub>	—		14	20	26	
D.ABL detection voltage	ΔV <sub>001</sub>	—	(Note V <sub>5</sub> )	30	50	70	mV
	ΔV <sub>010</sub>	—		90	110	130	
	ΔV <sub>100</sub>	—		220	240	260	
D.ABL sensitivity	S <sub>DAMIN</sub>	—	(Note V <sub>6</sub> )	—	0	0.04	V/V
	S <sub>DAMAX</sub>	—		0.280	0.295	0.310	
Black level correction	BLC	—	(Note V <sub>7</sub> )	6.5	7.0	7.5	IRE
Y γ correction point	P <sub>γ0</sub>	—	—	95	100	105	IRE
	P <sub>γ100</sub>	—		2	5	8	
Y γ correction gain	G <sub>γ01</sub>	—	—	-3.5	-2.5	-1.5	dB
	G <sub>γ10</sub>	—		-5.8	-4.8	-3.8	
	G <sub>γ11</sub>	—		-7.5	-6.5	-5.5	
Black peak detection level	ΔV <sub>BP</sub>	—	(Note V <sub>8</sub> )	-15	0	15	mV
DC restoration gain	ADT100	—	(Note V <sub>9</sub> )	0.9	1.0	1.1	times
	ADT130	—		1.25	1.35	1.45	
DC restoration start point	V <sub>DT0</sub>	—	(Note V <sub>10</sub> )	-3	0	3	%
	V <sub>DT48</sub>	—		42	47	51	
DC restoration limit point	P <sub>DTL60</sub>	—	(Note V <sub>11</sub> )	59	63	67	%
	P <sub>DTL73</sub>	—		71	75	79	
	P <sub>DTL87</sub>	—		83	87	91	
	P <sub>DTL100</sub>	—		95	99	103	
Sharpness peak frequency	F <sub>APL01</sub>	—	—	3.3	4.2	5.1	MHz
	F <sub>APL10</sub>	—		2.6	3.3	4.0	
	F <sub>APL11</sub>	—		2.0	2.5	3.0	
	F <sub>APH01</sub>	—		11.2	14.5	17.4	
	F <sub>APH10</sub>	—		9.5	11.9	14.3	
	F <sub>APH11</sub>	—		6.5	8.1	9.7	
Sharpness control range	G <sub>MAXL</sub>	—	(Note V <sub>12</sub> )	11	14	17	dB
	G <sub>MINL</sub>	—		-11	-8	-5	
	G <sub>MAXH</sub>	—		11	14	17	
	G <sub>MINH</sub>	—		-9	-6	-3	
Sharpness control center gain	G <sub>CENL</sub>	—	—	7	10	13	dB
	G <sub>CENH</sub>	—		7	10	13	

Characteristics	Symbol	Test Circuit	Test Condition	Min	Typ.	Max	Unit
YNR characteristic	G <sub>YL</sub>	—	(Note V <sub>13</sub> )	-11	-8	-5	dB
	G <sub>YH</sub>	—		-9	-6	-4	
SRT response to 2T pulse input	T <sub>SL1</sub>	—	(Note V <sub>14</sub> )	100	120	140	ns
	T <sub>SRTL</sub>	—		40	60	80	
	T <sub>SH1</sub>	—		160	180	200	
	T <sub>SRTH</sub>	—		20	30	45	
VSM peak frequency	F <sub>VL</sub>	—	When normal mode	7	9	11	MHz
	F <sub>VH</sub>	—	When double scan mode	12.5	16	19.5	
VSM gain	G <sub>VL00</sub>	—	(Note V <sub>15</sub> )	11	13	15	dB
	G <sub>VL01</sub>	—		-7.5	-6	-4.5	
	G <sub>VL10</sub>	—		-11	-9	-8	
	G <sub>VL11</sub>	—		-∞	-35	-29	
	G <sub>VH00</sub>	—		11	13	15	
	G <sub>VH01</sub>	—		-7.5	-6	-5	
	G <sub>VH10</sub>	—		-11	-9	-7	
	G <sub>VH11</sub>	—		-∞	-32	-26	
VSM parabolic modulating gain	G <sub>VRL</sub>	—	(Note V <sub>16</sub> )	-4	-3	-2	dB
	G <sub>VLL</sub>	—		-4	-3	-2	
	G <sub>VRH</sub>	—		-4	-3	-2	
	G <sub>VLH</sub>	—		-4	-3	-2	
Threshold voltage of VSM muting	V <sub>SR36</sub>	—	Pin 21, Pin 27	0.65	0.75	0.85	V
Response time for VSM high speed muting	T <sub>VML1</sub>	—	(Note V <sub>17</sub> )	0	50	100	ns
	T <sub>VML2</sub>	—		0	50	100	
	T <sub>VML3</sub>	—		0	50	100	
	T <sub>VML4</sub>	—		0	50	100	
	T <sub>VMH1</sub>	—		0	50	100	
	T <sub>VMH2</sub>	—		0	50	100	
	T <sub>VMH3</sub>	—		0	50	100	
	T <sub>VMH4</sub>	—		0	50	100	
Between Y <sub>2</sub> input and R output delay time	T <sub>Y2RD</sub>	—	When through	26	36	46	ns
	T <sub>Y2RL</sub>	—	When normal mode	200	220	240	
	T <sub>Y2RH</sub>	—	When double scan mode	85	100	115	

## Chroma Section

Characteristics		Symbol	Test Circuit	Test Condition	Min	Typ.	Max	Unit
ACC characteristic		F <sub>600</sub>	—	(Note C <sub>1</sub> )	0.300	0.355	0.410	V <sub>p-p</sub>
		F <sub>300</sub>	—		0.300	0.355	0.410	
		F <sub>30</sub>	—		0.290	0.343	0.400	
		F <sub>10</sub>	—		0.090	0.113	0.135	
		A	—		0.90	0.97	1.05	times
Sub color control characteristic		es+	—	—	2.0	3.0	4.0	dB
		es-	—		-6.0	-4.3	-2.0	
APC frequency control sensitivity		β <sub>3</sub>	—	(Note C <sub>2</sub> )	0.70	1.20	1.70	Hz/mV
		β <sub>4</sub>	—		0.70	1.20	1.70	
		β <sub>M</sub>	—		0.70	1.20	1.70	
APC pull-in/hold range		f <sub>3PH</sub>	—	(Note C <sub>3</sub> )	250	500	2000	Hz
		f <sub>3HH</sub>	—		250	500	2000	
		f <sub>3PL</sub>	—		-2000	-500	-250	
		f <sub>3HL</sub>	—		-2000	-500	-250	
		f <sub>4PH</sub>	—		250	500	2000	
		f <sub>4HH</sub>	—		250	500	2000	
		f <sub>4PL</sub>	—		-2000	-500	-250	
		f <sub>4HL</sub>	—		-2000	-500	-250	
		f <sub>MPH</sub>	—		250	500	2000	
		f <sub>MHH</sub>	—		250	500	2000	
		f <sub>MPL</sub>	—		-2000	-500	-250	
		f <sub>MHL</sub>	—		-2000	-500	-250	
3.58 MHz/4.43 MHz free run frequency		f <sub>03</sub>	—	f <sub>0</sub> = 3.579545 MHz	-200	0	200	Hz
		f <sub>04</sub>	—	f <sub>0</sub> = 4.433619 MHz	-200	0	200	
		f <sub>0M</sub>	—	f <sub>0</sub> = 3.575611 MHz	-200	0	200	
f <sub>sc</sub> output amplitude		f <sub>3c</sub>	—	When 3.58 NTSC	0.54	0.78	0.96	V <sub>p-p</sub>
		f <sub>4c</sub>	—	When 4.43 PAL	0.52	0.72	0.90	
		f <sub>Mc</sub>	—	When M-PAL	0.54	0.78	0.96	
f <sub>sc</sub> output DC level		V <sub>1a</sub>	—	When 3.58 NTSC	2.80	3.20	3.50	V
		V <sub>1b</sub>	—	Except for 3.58 NTSC	1.15	1.55	1.75	
IQ color difference signal output level	Q Axis	V <sub>BN</sub>	—	When B:C = 1:1 signal	290	355	415	mV <sub>p-p</sub>
	I Axis	V <sub>RN</sub>	—		290	355	415	
IQ signal demodulation ratio		V <sub>RN</sub> /V <sub>BN</sub>	—	R-Y/B-Y	0.94	1.00	1.15	—
IQ demodulation angle	Q Axis	θ <sub>BN</sub>	—	—	29.0	33.0	37.0	°
	I Axis	θ <sub>RN</sub>	—		118.0	123.0	126.0	
IQ demodulation angle	Relative	θ <sub>BRN</sub>	—	I-Q	87.0	90.0	93.0	°
UV color difference signal output level	B-Y	V <sub>BP</sub>	—	When B:C = 1:1 signal	290	355	415	mV <sub>p-p</sub>
	R-Y	V <sub>RP</sub>	—		290	355	415	
UV signal demodulation ratio		V <sub>RP</sub> /V <sub>BP</sub>	—	R-Y/B-Y	0.94	1.00	1.10	—
UV demodulation angle	B-Y	θ <sub>BP</sub>	—	—	-5.0	0.0	3.0	°
	R-Y	θ <sub>RP</sub>	—		85.0	90.0	93.0	
UV demodulation angle	Relative	θ <sub>BRP</sub>	—	—	87.0	90.0	93.0	°

Characteristics		Symbol	Test Circuit	Test Condition	Min	Typ.	Max	Unit
Residual carrier level		V <sub>BNe</sub>	—	f <sub>sc</sub> level	—	1.90	4.00	mV <sub>p-p</sub>
		V <sub>RNe</sub>	—		—	1.90	4.00	
		V <sub>BPe</sub>	—		—	1.90	4.00	
		V <sub>RPe</sub>	—		—	1.90	4.00	
Residual higher harmonics level		V <sub>BHNe</sub>	—	f <sub>sc</sub> × 2 level	—	1.90	4.00	mV <sub>p-p</sub>
		V <sub>RHNe</sub>	—		—	1.90	4.00	
		V <sub>BHPe</sub>	—		—	1.90	4.00	
		V <sub>RHPe</sub>	—		—	1.90	4.00	
Color difference output DC voltage	3.58 NTSC	V <sub>BN</sub>	—	B-Y output	1.80	2.15	2.50	V
		V <sub>RN</sub>	—	R-Y output	1.90	2.24	2.60	
	4.43 NTSC	V <sub>BP</sub>	—	B-Y output	1.80	2.15	2.50	
		V <sub>RP</sub>	—	R-Y output	1.90	2.25	2.60	
1HDL output DC level	PAL	V <sub>DLP</sub>	—	Output from pin	8.00	8.30	8.60	V
	NTSC	V <sub>DLS</sub>	—		4.00	4.30	4.60	
	SECAM	V <sub>DLN</sub>	—		0.01	0.50	0.20	
Sand castle pulse height	CP	SCH	—	—	7.50	7.80	8.10	V
	HD	SCM	—		3.95	4.20	4.45	
	VD	SCL	—		2.25	2.50	2.75	
SECAM output DC level		SEN	—	(Note C <sub>4</sub> )	3.70	4.00	4.30	V
		SEP	—		3.70	4.00	4.30	
		SES	—		0.40	0.70	1.00	
NTSC ident sensitivity		v <sub>NCL</sub>	—	(Note C <sub>5</sub> )	3.80	5.83	7.87	mV <sub>p-p</sub>
		v <sub>NCH</sub>	—		2.52	3.88	5.24	
		v <sub>NBL</sub>	—		3.73	5.74	7.75	
		v <sub>NBH</sub>	—		2.44	3.75	5.06	
PAL ident sensitivity		v <sub>PCL</sub>	—	(Note C <sub>6</sub> )	4.80	6.83	8.87	mV <sub>p-p</sub>
		v <sub>PCH</sub>	—		3.52	4.88	6.24	
		v <sub>PBL</sub>	—		4.73	6.74	8.75	
		v <sub>PBH</sub>	—		3.44	4.75	6.06	
TOF characteristic		GF <sub>H3</sub>	—	(Note C <sub>7</sub> )	20.7	22.7	24.7	dB
		GF <sub>C3</sub>	—		20.2	22.2	24.2	
		GF <sub>L3</sub>	—		18.2	20.2	22.2	
		GF <sub>H4</sub>	—		19.1	21.1	23.1	
		GF <sub>C4</sub>	—		19.4	21.4	23.4	
		GF <sub>L4</sub>	—		18.8	20.8	22.8	
Y <sub>1</sub> in to Y <sub>1</sub> out AC gain	Through	GY <sub>s</sub>	—	20 log (output level/input level)	-1.21	0.00	1.06	dB
	Normal	GY <sub>d</sub>	—		-1.21	0.00	1.06	
	Double	GY <sub>t</sub>	—		-1.21	0.00	1.06	
Y <sub>1</sub> in to Y <sub>1</sub> out frequency bandwidth		Gf <sub>Y1</sub>	—	—	-4.0	-1.0	0.0	dB
Trap filter gain	3.58	GT <sub>C3</sub>	—	—	—	-25	-20	dB
	4.43	GT <sub>C4</sub>	—		—	-25	-20	
Y <sub>1</sub> input dynamic range	3.58 NTSC	VD <sub>3</sub>	—	—	1.30	1.60	—	V <sub>p-p</sub>
	4.43 PAL	VD <sub>4</sub>	—		1.30	1.60	—	

## Text Section

Characteristics		Symbol	Test Circuit	Test Condition	Min	Typ.	Max	Unit
AC gain		$G_R$	—	(Note T <sub>1</sub> )	2.95	3.30	3.70	times
		$G_G$	—		2.95	3.30	3.70	
		$G_B$	—		2.95	3.30	3.70	
AC gain axial difference		$G_{G/R}$	—	—	0.94	1.00	1.06	—
		$G_{B/R}$	—		0.94	1.00	1.06	
Output bandwidth	R	$G_{fR}$	—	at -3dB point	25	30	—	MHz
	G	$G_{fG}$	—		25	30	—	
	B	$G_{fB}$	—		25	30	—	
Uni-color control characteristic		$v_uMAX$	—	(Note T <sub>2</sub> )	0.59	0.66	0.74	$V_{p-p}$
		$v_uCNT$	—		0.34	0.39	0.44	
		$v_uMIN$	—		0.09	0.11	0.13	
		$\Delta v_u$	—		14	15	16	dB
Brightness control characteristic		$V_{brMAX}$	—	(Note T <sub>3</sub> )	4.1	4.4	4.7	V
		$V_{brCNT}$	—		3.25	3.55	3.85	
		$V_{brMIN}$	—		2.4	2.7	3.0	
Brightness control sensitivity		$G_{br}$	—	(Note T <sub>4</sub> )	5.7	6.6	7.5	mV
White peak slice level		$V_{wps1}$	—	(Note T <sub>5</sub> )	2.75	2.95	3.15	$V_{p-p}$
		$V_{wps2}$	—		2.30	2.50	2.70	
Black peak slice level		$V_{BPS}$	—	(Note T <sub>6</sub> )	2.10	2.26	2.42	V
Signal-to-noise ratio of RGB output	R	$N_{41}$	—	—	—	-58	-49	dB
	G	$N_{42}$	—		—	-58	-49	
	B	$N_{43}$	—		—	-58	-49	
Half-tone gain		$G_{HT1}$	—	(Note T <sub>7</sub> )	0.45	0.50	0.55	times
		$G_{HT2}$	—		0.45	0.50	0.55	
Half-tone ON voltage		$V_{HT}$	—	Pin 6	0.65	0.85	1.05	V
V-BLK pulse output level	R	$V_{VR}$	—	—	0.3	0.8	1.3	V
	G	$V_{VG}$	—		0.3	0.8	1.3	
	B	$V_{VB}$	—		0.3	0.8	1.3	
H-BLK pulse output level	R	$V_{HR}$	—	—	0.3	0.8	1.3	V
	G	$V_{HG}$	—		0.3	0.8	1.3	
	B	$V_{HB}$	—		0.3	0.8	1.3	
Blanking pulse delay time		$t_{dON}$	—	(Note T <sub>8</sub> )	—	0.1	0.3	$\mu s$
		$t_{dOFF}$	—		—	0.15	0.3	
Sub-contrast control range		$\Delta V_{SU+}$	—	—	2.0	2.5	3.0	dB
		$\Delta V_{SU-}$	—		-3.8	-3.3	-2.8	
RGB output voltage		$V_{\#41}$	—	(Note T <sub>9</sub> )	2.25	2.50	2.75	V
		$V_{\#42}$	—		2.25	2.50	2.75	
		$V_{\#43}$	—		2.25	2.50	2.75	
RGB output voltage triaxial difference		$\Delta V_{out}$	—	—	—	0	150	mV
Cut-off voltage control range		CUT+	—	(Note T <sub>10</sub> )	0.45	0.50	0.55	V
		CUT-	—		0.45	0.50	0.55	

Characteristics	Symbol	Test Circuit	Test Condition	Min	Typ.	Max	Unit
Drive adjustment control range	DRG+	—	(Note T <sub>11</sub> )	2.35	2.85	3.35	dB
	DRG-	—		-5.75	-5.00	-4.25	
	DRB+	—		2.35	2.85	3.35	
	DRB-	—		-5.75	-5.00	-4.25	
	DRR+	—		2.35	2.85	3.35	
	DRR-	—		-5.75	-5.00	-4.25	
Output voltage of muting	MURD	—	(Note T <sub>12</sub> )	2.1	2.26	2.42	V
	MUGD	—		2.1	2.26	2.42	
Output voltage of blue back	BB <sub>R</sub>	—	(Note T <sub>13</sub> )	2.1	2.26	2.42	V
	BB <sub>G</sub>	—		2.1	2.26	2.42	
	BB <sub>B</sub>	—		1.15	1.30	1.45	V <sub>p-p</sub>
ACL characteristic	ACL1	—	(Note T <sub>14</sub> )	-5	-3	-1	dB
	ACL2	—		-14.5	-13	-11.5	
ABL point	ABL <sub>P1</sub>	—	(Note T <sub>15</sub> )	0.12	0.17	0.22	V
	ABL <sub>P2</sub>	—		0.04	0.09	0.14	
	ABL <sub>P3</sub>	—		-0.05	0.00	0.05	
	ABL <sub>P4</sub>	—		-0.15	-0.10	-0.05	
	ABL <sub>P5</sub>	—		-0.24	-0.19	-0.14	
	ABL <sub>P6</sub>	—		-0.34	-0.29	-0.24	
	ABL <sub>P7</sub>	—		-0.43	-0.38	-0.33	
	ABL <sub>P8</sub>	—		-0.50	-0.45	-0.40	
ABL gain	ABL <sub>G1</sub>	—	(Note T <sub>16</sub> )	-0.04	0.00	0.00	V
	ABL <sub>G2</sub>	—		-0.09	-0.04	0.00	
	ABL <sub>G3</sub>	—		-0.24	-0.19	-0.14	
	ABL <sub>G4</sub>	—		-0.40	-0.35	-0.30	
	ABL <sub>G5</sub>	—		-0.56	-0.51	-0.46	
	ABL <sub>G6</sub>	—		-0.73	-0.68	-0.63	
	ABL <sub>G7</sub>	—		-0.90	-0.85	-0.80	
	ABL <sub>G8</sub>	—		-0.10	-0.92	-0.87	
RGB output mode	V43 <sub>R</sub>	—	(Note T <sub>17</sub> )	2.25	2.5	2.75	V
	V42 <sub>R</sub>	—		0.3	0.8	1.3	
	V41 <sub>R</sub>	—		0.3	0.8	1.3	
	V43 <sub>G</sub>	—		0.3	0.8	1.3	
	V42 <sub>G</sub>	—		2.25	2.5	2.75	
	V41 <sub>G</sub>	—		0.3	0.8	1.3	
	V43 <sub>B</sub>	—		0.3	0.8	1.3	
	V42 <sub>B</sub>	—		0.3	0.8	1.3	
	V41 <sub>B</sub>	—		2.25	2.5	2.75	
ACB pulse phase/amplitude	θ <sub>ACBR</sub>	—	(Note T <sub>18</sub> )	—	1	—	H
	θ <sub>ACBG</sub>	—		—	2	—	
	θ <sub>ACBB</sub>	—		—	3	—	
	V <sub>ACBR</sub>	—		0.1	0.125	0.15	V <sub>p-p</sub>
	V <sub>ACBG</sub>	—		0.1	0.125	0.15	
	V <sub>ACBB</sub>	—		0.1	0.125	0.15	

Characteristics		Symbol	Test Circuit	Test Condition	Min	Typ.	Max	Unit
IK input level		IKR	—	Pin 73 input level	1.45	1.65	1.85	V
		IKG	—		1.45	1.65	1.85	
		IKB	—		1.45	1.65	1.85	
RGB $\gamma$ correction characteristic		$\gamma_{1R}$	—	(Note T <sub>19</sub> )	40	50	60	IRE
		$\gamma_{2R}$	—		60	70	80	
		$\Delta_{1R}$	—		0.75	1.50	2.25	dB
		$\Delta_{2R}$	—		-0.75	0.00	0.75	
		$\Delta_{3R}$	—		-4.05	-3.30	-2.55	
		$\gamma_{1G}$	—		40	50	60	IRE
		$\gamma_{2G}$	—		60	70	80	
		$\Delta_{1G}$	—		0.75	1.50	2.25	dB
		$\Delta_{2G}$	—		-0.75	0.00	0.75	
		$\Delta_{3G}$	—		-4.05	-3.30	-2.55	
		$\gamma_{1B}$	—		40	50	60	IRE
		$\gamma_{2B}$	—		60	70	80	
		$\Delta_{1B}$	—		0.75	1.50	2.25	dB
		$\Delta_{2B}$	—		-0.75	0.00	0.75	
		$\Delta_{3B}$	—		-4.05	-3.30	-2.55	
Analog RGB gain		G <sub>TXR</sub>	—	(Note T <sub>20</sub> )	4.0	4.5	5.0	times
		G <sub>TXG</sub>	—		4.0	4.5	5.0	
		G <sub>TXB</sub>	—		4.0	4.5	5.0	
Analog RGB gain triaxial difference		G <sub>TXG/R</sub>	—	—	0.94	1.00	1.06	—
		G <sub>TXB/R</sub>	—		0.94	1.00	1.06	
Analog RGB bandwidth	R	G <sub>fTXR</sub>	—	at -3dB point	25	30	—	dB
	G	G <sub>fTXG</sub>	—		25	30	—	
	B	G <sub>fTXB</sub>	—		25	30	—	
Analog RGB input dynamic range	R	DR35	—	—	0.6	1.0	1.5	V <sub>p-p</sub>
	G	DR34	—		0.6	1.0	1.5	
	B	DR33	—		0.6	1.0	1.5	
Analog RGB white peak slice level		V <sub>TXWPSR</sub>	—	(Note T <sub>21</sub> )	2.30	2.55	2.80	V <sub>p-p</sub>
		V <sub>TXWPSG</sub>	—		2.30	2.55	2.80	
		V <sub>TXWPSB</sub>	—		2.30	2.55	2.80	
Analog RGB black peak limiter level		V <sub>BPSR</sub>	—	(Note T <sub>22</sub> )	2.10	2.26	2.42	V
		V <sub>BPSG</sub>	—		2.10	2.26	2.42	
		V <sub>BPSB</sub>	—		2.10	2.26	2.42	

Characteristics	Symbol	Test Circuit	Test Condition	Min	Typ.	Max	Unit
RGB contrast control characteristic	$vuTXR_{MAX}$	—	(Note T <sub>23</sub> )	0.8	0.9	1.0	$V_{p-p}$
	$vuTXG_{MAX}$	—		0.8	0.9	1.0	
	$vuTXB_{MAX}$	—		0.8	0.9	1.0	
	$vuTXR_{CNT}$	—		0.45	0.52	0.59	
	$vuTXG_{CNT}$	—		0.45	0.52	0.59	
	$vuTXB_{CNT}$	—		0.45	0.52	0.59	
	$vuTXR_{MIN}$	—		0.10	0.12	0.14	
	$vuTXG_{MIN}$	—		0.10	0.12	0.14	
	$vuTXB_{MIN}$	—		0.10	0.12	0.14	
	$\Delta vuTXR$	—		15.5	17.0	18.5	dB
	$\Delta vuTXG$	—		15.5	17.0	18.5	
	$\Delta vuTXB$	—		15.5	17.0	18.5	
Analog RGB brightness control characteristic	$VbrTXMAX$	—	(Note T <sub>24</sub> )	3.3	3.5	3.7	V
	$VbrTXCNT$	—		2.85	3.05	3.25	
	$VbrTXMIN$	—		2.45	2.65	2.85	
Analog RGB brightness control sensitivity	$GbrTX$	—	(Note T <sub>25</sub> )	6.0	6.8	7.6	mV
Analog RGB mode ON voltage	$V_{TXON}$	—	Pin 27	0.65	0.85	1.05	V
Text ACL characteristic	$TXACL1$	—	(Note T <sub>26</sub> )	-2	-1	-0.05	dB
	$TXACL2$	—		-6.5	-4.5	-2.5	
	$TXACL3$	—		-6.5	-4.5	-2.5	
	$TXACL4$	—		-16.5	-15.0	-13.5	
Analog OSD gain	$GOSD_R$	—	(Note T <sub>27</sub> )	4.1	4.8	5.4	times
	$GOSD_G$	—		4.1	4.8	5.4	
	$GOSD_B$	—		4.1	4.8	5.4	
Analog OSD gain triaxial difference	$GOSD_{G/R}$	—	G/R	0.94	1.00	1.06	—
	$GOSD_{B/R}$	—	B/R	0.94	1.00	1.06	—
Analog OSD band width	$GfOSD_R$	—	at -3dB point	25	30	—	dB
	$GfOSD_G$	—		25	30	—	
	$GfOSD_B$	—		25	30	—	
Analog OSD white peak slice level	$V_{OSD1R}$	—	(Note T <sub>28</sub> )	1.80	2.00	2.20	$V_{p-p}$
	$V_{OSD1G}$	—		1.80	2.00	2.20	
	$V_{OSD1B}$	—		1.80	2.00	2.20	
	$V_{OSD2R}$	—		1.45	1.65	1.85	
	$V_{OSD2G}$	—		1.45	1.65	1.85	
	$V_{OSD2B}$	—		1.45	1.65	1.85	
Analog OSD black peak limiter level	$V_{OSD3R}$	—	(Note T <sub>29</sub> )	2.10	2.26	2.42	V
	$V_{OSD3G}$	—		2.10	2.26	2.42	
	$V_{OSD3B}$	—		2.10	2.26	2.42	
Analog OSD output DC voltage	$V_{OSDDCR}$	—	(Note T <sub>30</sub> )	2.3	2.5	2.7	V
	$V_{OSDDCG}$	—		2.3	2.5	2.7	
	$V_{OSDDCB}$	—		2.3	2.5	2.7	
Analog OSD mode ON voltage	$V_{OSDON}$	—	Pin 21	2.05	2.30	2.55	V



Characteristics	Symbol	Test Circuit	Test Condition	Min	Typ.	Max	Unit
OSD ACL characteristic	OSDA CL1	—	(Note T <sub>31</sub> )	—	0	—	dB
	OSDA CL2	—		—	0	—	
	OSDA CL3	—		-6.5	-4.5	-2.5	
	OSDA CL4	—		-16.5	-15	-13.5	
Crosstalk of RGB inputs	GCT	—	—	-50	-45	dB	

## Color Difference Section

Characteristics	Symbol	Test Circuit	Test Condition	Min	Typ.	Max	Unit
Color difference signal contrast control characteristic	$v_{uCY_{MAX}}$	—	(Note A <sub>1</sub> )	1.5	1.8	2.13	$V_{p-p}$
	$v_{uCY_{CNT}}$	—		0.85	1.0	1.2	
	$v_{uCY_{MIN}}$	—		0.24	0.29	0.355	dB
	$\Delta v_{uCY}$	—		14.0	15.5	17.0	
Color control characteristic	$v_{uCY_{MAX}}$	—	(Note A <sub>2</sub> )	1.18	1.4	1.68	$V_{p-p}$
	$v_{uCY_{CNT}}$	—		0.73	0.86	1.04	
	$v_{uCY_{MIN}}$	—		0.076	0.090	0.108	dB
	$\Delta v_{uCY+}$	—		3	4	5	
	$\Delta v_{uCY-}$	—		-20	-18	-16	
R-Y relative phase	00	$\theta R_{90}$	—	88	90	92	°
	01	$\theta R_{93}$		90	92	94	
	10	$\theta R_{96}$		92	94	96	
	11	$\theta_{112}$		109	111	113	
R-Y relative amplitude	00	$vR_{56/vB}$	—	0.55	0.58	0.61	times
	01	$vR_{68/vB}$		0.67	0.7	0.73	
	10	$vR_{76/vB}$		0.78	0.81	0.84	
	11	$vR_{84/vB}$		0.85	0.88	0.91	
G-Y relative phase	00	$\theta G_{236}$	—	234	237	240	°
	01	$\theta G_{240}$		238	241	244	
	10	$\theta G_{244}$		242	245	248	
	11	$\theta G_{253}$		251	254	257	
G-Y relative amplitude	00	$vG_{30/vB}$	—	0.275	0.300	0.325	times
	01	$vG_{325/vB}$		0.300	0.325	0.350	
	10	$vG_{35/vB}$		0.325	0.350	0.375	
	11	$Gv_{375/vB}$		0.350	0.375	0.400	
Color difference half-tone gain	R	$GHT_{RY}$	(Note A <sub>3</sub> )	0.47	0.50	0.53	times
	G	$GHT_{GY}$		0.47	0.50	0.53	
	B	$GHT_{BY}$		0.47	0.50	0.53	
Color $\gamma$ characteristic	$V_{\gamma 1}$	—	(Note A <sub>4</sub> )	0.09	0.23	0.37	$V_{p-p}$
	$V_{\gamma 2}$	—		0.23	0.37	0.51	
	$V_{\gamma 3}$	—		0.38	0.52	0.66	
	$\Delta\gamma$	—		0.65	0.75	0.85	—
Color limiter characteristic	CLT0	—	(Note A <sub>5</sub> )	1.45	1.65	1.85	$V_{p-p}$
	CLT1	—		1.8	2.0	2.2	
High bright color gain	HBC1	—	(Note A <sub>6</sub> )	0.02	0.04	0.06	times

Characteristics		Symbol	Test Circuit	Test Condition	Min	Typ.	Max	Unit
Base band tint control characteristic	Max	$\theta_{TRMAX}$	—	R	29	33	37	°
		$\theta_{TBMAX}$	—	B	29	33	37	
	Min	$\theta_{TRMIN}$	—	R	-37	-33	-29	
		$\theta_{TBMIN}$	—	B	-37	-33	-29	
Flesh color characteristic		Fa33	—	(Note A7)	0.38	0.48	0.58	—
Color difference signal input dynamic range		DR <sub>R-Y</sub>	—	—	0.9	1.2	1.5	V <sub>p-p</sub>
		DR <sub>B-Y</sub>	—	—	0.9	1.2	1.5	
Color detail emphasis characteristic		GCD0	—	(Note A8)	15.0	18.0	21.0	V <sub>p-p</sub>
		GCD1	—		—	-15.0	0.0	
Phase shift at IQ → UV conversion		$\theta_I \rightarrow U$	—	—	31	33	35	°
		$\theta_Q \rightarrow V$	—		31	33	35	

## DEF Section

Characteristics		Symbol	Test Circuit	Test Condition	Min	Typ.	Max	Unit
32f <sub>H</sub> VCO oscillation start voltage		V <sub>VCO</sub>	—	DEF V <sub>CC</sub> Voltage	3.1	3.4	3.7	V
Horizontal output start voltage		V <sub>HON23</sub>	—		4.7	5.0	5.3	V
Horizontal output duty cycle		T <sub>23</sub>	—	Pin 41	38.5	40.5	42.5	%
Horizontal output free-run frequency		f <sub>H050</sub>	—	Vertical freq.; Auto	15475	15625	15775	Hz
		f <sub>H060</sub>	—	Vertical freq.; 60 Hz	15585	15734	15885	
Variable range of horizontal output frequency		f <sub>HMIN</sub>	—	Variable pin 45 voltage	14700	15000	15300	Hz
		f <sub>HMAX</sub>	—		16500	16700	16900	
Horizontal output frequency control sensitivity		$\beta_H$	—	(Note D1)	180	230	280	Hz/ 0.1 V
Horizontal output voltage		High level	V <sub>H23</sub>	Pin 40	2.7	3.0	3.3	V
		Low level	V <sub>L23</sub>		—	0.15	0.30	
Horizontal output phase		SPH1	—	(Note D2)	11.1	11.3	11.5	V
		SPH2	—		0.35	0.45	0.55	
		SPH3	—		0.11	0.21	0.31	
Curve correction characteristic		$\Delta H_{24}$	—	(Note D3)	2.3	2.5	2.7	V
Variable range of horizontal picture position		$\Delta H_{SFT}$	—	(Note D4)	5.7	6.2	6.7	V
Clamp pulse start phase		CP <sub>S</sub>	—	(Note D5)	2.8	2.9	3.1	V
Clamp pulse width		CP <sub>W</sub>	—		1.0	1.2	1.4	V
Threshold of external clamp pulse input		CP <sub>V30</sub>	—	Pin 40	3.3	3.6	3.9	V
Threshold of external clamp mode switching		CPM <sub>V23</sub>	—	Pin 41	8.5	8.7	8.9	V
Threshold of external black peak hold stopping pulse		BP <sub>V17</sub>	—	Pin 49, at normal scan	0.9	1.1	1.3	—
		BP <sub>V24</sub>	—	Pin 40, at double scan	0.9	1.1	1.3	
SPC gate pulse start phase		GP <sub>S</sub>	—	(Note D6)	1.9	2.1	2.3	μs
SPC gate pulse width		GP <sub>W</sub>	—		1.9	2.1	2.3	μs

Characteristics	Symbol	Test Circuit	Test Condition	Min	Typ.	Max	Unit	
SPC horizontal blanking pulse start phase	HP <sub>S</sub>	—	(Note D7)	4.6	4.8	5.0	μs	
SPC horizontal blanking pulse pulse width	HP <sub>W50</sub>	—		9.9	10.4	10.9	μs	
	HP <sub>W60</sub>	—	10.5	11.0	11.5			
HD output start phase	HD <sub>S</sub>	—	(Note D8)	0.7	0.9	1.1	μs	
HD output pulse width	HD <sub>W</sub>	—		0.7	0.9	1.1	μs	
HD output voltage	V <sub>HD</sub>	—		4.5	4.8	5.1	V	
Threshold of AFC-2 detection	V <sub>HBLK1</sub>	—	Pin 38, at normal scan	3.2	3.5	3.8	V	
Threshold of horizontal timing	V <sub>HBLK2</sub>	—	Pin 38, at doble scan	3.2	3.5	3.8	V	
Threshold of blanking pulse	V <sub>HBLK3</sub>	—	Pin 38, H/V blanking	0.8	1.1	1.4	V	
Vertical blanking pulse start phase	VP <sub>50S1</sub>	—	(Note D9)	46	48	50	μs	
Vertical blanking pulse stop phase	VP <sub>50S2</sub>	—		—	23	—	H	
Vertical blanking pulse start phase	VP <sub>60S1</sub>	—	(Note D10)	46	48	50	μs	
Vertical blanking pulse stop phase	VP <sub>60S2</sub>	—		—	21	—	H	
External blanking threshold current	ABLK	—	Pin 30 input current	150	300	400	μA	
Vertical output start voltage	V <sub>ON</sub>	—	DEF V <sub>CC</sub> voltage	4.7	5.0	5.3	V	
Vertical output	f <sub>V050</sub>	—	Vertical freq.; Auto	40	45	50	Hz	
Free-run frequency	f <sub>V060</sub>	—	Vertical freq.; 60 Hz	48	53	58		
Vertical output voltage	V <sub>VH</sub>	—	Pin 29	4.7	5.0	5.3	V	
	V <sub>VL</sub>	—		—	0.0	0.3		
Vertical pull-in range (1)	f <sub>PL1</sub>	—	(Note D11)	—	224.5	—	H	
	f <sub>PH1</sub>	—		—	353	—		
Vertical pull-in range (2)	f <sub>PL2</sub>	—		—	224.5	—	H	
	f <sub>PH2</sub>	—		—	297	—		
Vertical pull-in range (3)	f <sub>50P</sub>	—		—	288.5	—	H	
Vertical pull-in range (4)	f <sub>60P</sub>	—		—	288	—	H	
RGB vertical blanking pulse start phase (1)	VR <sub>50S1</sub>	—		(Note D12)	44	46	48	μs
	VG <sub>50S1</sub>	—			44	46	48	
	VB <sub>50S1</sub>	—	44		46	48		
RGB vertical blanking pulse stop phase (1)	VR <sub>50S2</sub>	—	—		19	—	H	
	VG <sub>50S2</sub>	—	—		19	—		
	VB <sub>50S2</sub>	—	—		19	—		
RGB vertical blanking pulse start phase (2)	VR <sub>60S1</sub>	—	(Note D13)	44	46	48	μs	
	VG <sub>60S1</sub>	—		44	46	48		
	VB <sub>60S1</sub>	—		44	46	48		
RGB vertical blanking pulse stop phase (2)	VR <sub>60S2</sub>	—		—	17	—	H	
	VG <sub>60S2</sub>	—		—	17	—		
	VB <sub>60S2</sub>	—		—	17	—		

## Test Conditions

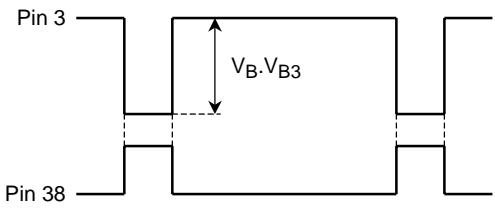
Note	Parameter	Test Conditions (unless otherwise stated, $V_{CC1} = 5\text{ V}$ , $V_{CC2}/V_{CC3}/\text{DEF } V_{CC} = 9\text{ V}$ , $T_a = 25 \pm 3^\circ\text{C}$ )				Test Conditions
		Switching Mode				
		SW <sub>15</sub>	SW <sub>49</sub>	SW <sub>50</sub>	SW <sub>53</sub>	
	Video Block					<p>Video block common test conditions</p> <ol style="list-style-type: none"> <li>1) SW<sub>13</sub>: A, SW<sub>18</sub>: ON, SW<sub>20</sub>: ON, SW<sub>23</sub>: ON, SW<sub>33</sub>: A, SW<sub>34</sub>: A, SW<sub>35</sub>: A, SW<sub>37</sub>: A, SW<sub>38</sub>: A, SW<sub>39</sub>: A, SW<sub>46</sub>: ON, SW<sub>51</sub>: B, SW<sub>52</sub>: B</li> <li>2) For testing, see the picture sharpness AC characteristics testing circuit diagram. After using the preset values to transmit the BUS control data, set ACB operation switching to ACB off (01).</li> <li>3) Ensure the composite signal is always input to pin 52 (Y<sub>1</sub>/sync input).</li> </ol>
V <sub>1</sub>	Black Detect Level Shift	C	OFF	C	C	<ol style="list-style-type: none"> <li>1) Set the BUS control data to the preset value.</li> <li>2) Connect pin 78 to an external power supply (PS) and observe pin 2.</li> <li>3) Turn the Y mute off (1), turn the black stretch gain off (1), and set the black detect level to 0 IRE (1).</li> <li>4) Increase the PS voltage from 5 V and measure the DC differential V<sub>B</sub> of pin 3 where the picture period (high period) of pin 2 goes low.</li> <li>5) Set the black detect level to 3 IRE (0).</li> <li>6) As in 4), measure the DC differential V<sub>B3</sub> of pin 3.</li> </ol> 
V <sub>2</sub>	Black Stretch Amp Maximum Gain	↑	↑	A	A	<ol style="list-style-type: none"> <li>1) Set the BUS control data to the preset value.</li> <li>2) Set SW<sub>50</sub> to A (maximum gain) and input a 500 kHz sine wave to TP78.</li> <li>3) Use pin 78 to adjust the signal amplitude to 0.1 V<sub>p-p</sub>.</li> <li>4) Turn the Y mute off (1), turn the black stretch gain off (1), and measure the amplitude V<sub>A</sub> of pin 3.</li> <li>5) Turn the black stretch gain on (0) and measure the amplitude V<sub>B</sub> of pin 3.</li> <li>6) Calculate the G<sub>BS</sub> using the following formula.  <math display="block">G_{BS} = V_B \div V_A</math> </li> </ol>

Note	Parameter	Test Conditions (unless otherwise stated, $V_{CC1} = 5\text{ V}$ , $V_{CC2}/V_{CC3}/\text{DEF } V_{CC} = 9\text{ V}$ , $T_a = 25 \pm 3^\circ\text{C}$ )				Test Conditions
		Switching Mode				
		SW <sub>15</sub>	SW <sub>49</sub>	SW <sub>50</sub>	SW <sub>53</sub>	
V <sub>3</sub>	Black Stretch Start Point (1)	C	OFF	A	C	<ol style="list-style-type: none"> <li>1) Set the BUS control data to the preset value.</li> <li>2) Set SW<sub>50</sub> to A (maximum gain), turn the Y mute off (1), and turn the black stretch gain off.</li> <li>3) Connect pin 78 to an external power supply (PS), increase the voltage from V<sub>53</sub>, and plot the resulting change in voltage S<sub>1</sub> of pin 3.</li> <li>4) Next, turn the black stretch gain on (0), set the black stretch point 1 to the minimum (000), increase the PS voltage from V<sub>53</sub> as in 3), and plot the resulting change in voltage S<sub>2</sub> of pin 3.</li> <li>5) Set the black stretch point 1 to the maximum (111), increase the PS voltage from V<sub>53</sub> as in 3), and plot the change in voltage S<sub>3</sub> of pin 3.</li> <li>6) Use the diagram below to calculate the intersections V<sub>BST1</sub> and V<sub>BST2</sub> of S<sub>1</sub>, S<sub>2</sub>, and S<sub>3</sub>. Use the following formulas to calculate P<sub>BST1</sub> and P<sub>BST2</sub>.  <math display="block">P_{BST1} \text{ [(IRE)]} = ((V_{BST1} \text{ [V]} - V_{49} \text{ [V]} \div 1.4 \text{ [V]}) \times 100 \text{ [(IRE)]}</math> <math display="block">P_{BST2} \text{ [(IRE)]} = ((V_{BST2} \text{ [V]} - V_{49} \text{ [V]} \div 1.4 \text{ [V]}) \times 100 \text{ [(IRE)]}</math> </li> </ol>

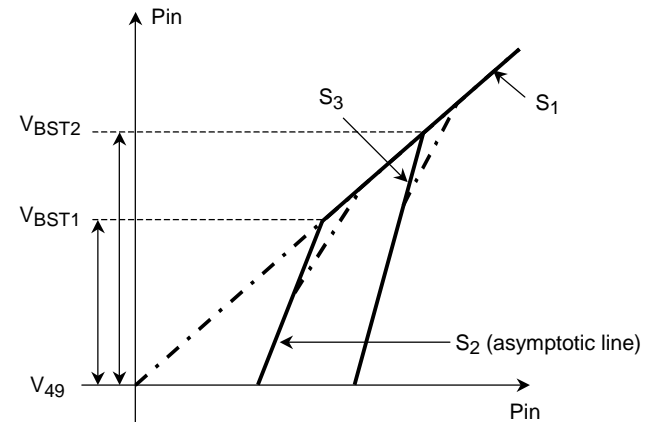

Note	Parameter	Test Conditions (unless otherwise stated, $V_{CC1} = 5\text{ V}$ , $V_{CC2}/V_{CC3}/\text{DEF } V_{CC} = 9\text{ V}$ , $T_a = 25 \pm 3^\circ\text{C}$ )				Test Conditions
		Switching Mode				
		SW <sub>15</sub>	SW <sub>49</sub>	SW <sub>50</sub>	SW <sub>53</sub>	
V <sub>4</sub>	Black Stretch Start Point (2)	C	ON	A	A	<p>1) Set the BUS control data to the preset value.</p> <p>2) Turn the black stretch gain off (1), turn the Y mute off (1), and turn the video mute off (0). Input the TG7 linearity to TP53, use pin 78 to adjust the amplitude as in the diagram, set unicolor to the center (1000000), and measure the resulting amplitude (<math>V_{43}</math>) of pin 11 (R OUT).</p> <p>3) Turn the black stretch gain on (0), connect pin 3 to an external power supply (PS), and measure pin 11 (R OUT).</p> <p>4) When the black stretch start point 2 data are at the minimum (000), calculate as in the diagram the black stretch start point differential <math>\Delta V_{000}</math> for when P is <math>V_{49}</math> (APL 0%) and for when P is <math>V_{49} + 1.0\text{ [V]}</math> (APL 100%).</p> <p>5) Next, when the black stretch start point 2 data are maximum (111), calculate differential <math>\Delta V_{111}</math> in the same way.</p> <p>6) Calculate the following formulas.  <math>P_{BS1} = (\Delta V_{000}/V_{43}) \times 100</math>  <math>P_{BS2} = (\Delta V_{111}/V_{43}) \times 100</math></p>

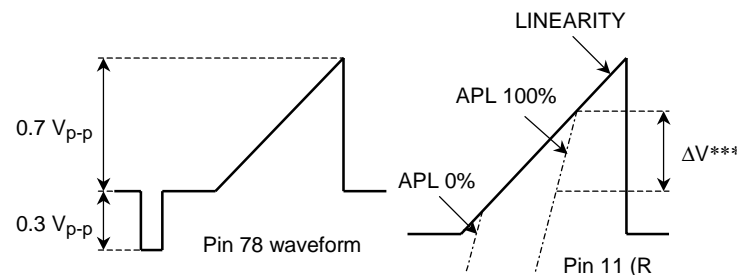

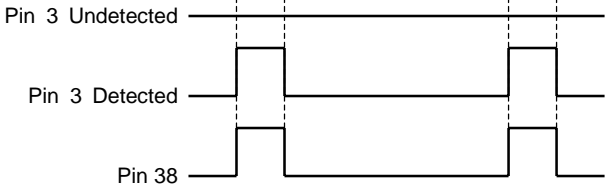
Note	Parameter	Test Conditions (unless otherwise stated, $V_{CC1} = 5\text{ V}$ , $V_{CC2}/V_{CC3}/DEF\ V_{CC} = 9\text{ V}$ , $T_a = 25 \pm 3^\circ\text{C}$ )				
		Switching Mode				Test Conditions
		SW <sub>15</sub>	SW <sub>49</sub>	SW <sub>50</sub>	SW <sub>53</sub>	
V <sub>5</sub>	D.ABL Detect Voltage	C	OFF	A	C	<p>1) Set the BUS control data to the preset value.</p> <p>2) Turn the Y mute off (1), set the ABL sensitivity to the minimum (000), set the D.ABL sensitivity to the maximum (111), and turn the black stretch gain off (1).</p> <p>3) Connect pin 8 to an external power supply (PS) and decrease the voltage from 6.5 V.</p> <p>4) Repeat 3) when the D.ABL detect voltage bus data are 000, 001, 010, and 100 respectively. Measure PS voltages <math>V_{000}</math>, <math>V_{001}</math>, <math>V_{010}</math>, and <math>V_{100}</math> when the picture period of pin 3 changes to low. (enlarge the range before measuring.)</p> <p>5) Next, calculate the <math>\Delta V_{001}</math>, <math>\Delta V_{010}</math>, and <math>\Delta V_{100}</math> voltage differentials from <math>V_{000}</math> and <math>V_{001}</math>, <math>V_{010}</math>, and <math>V_{100}</math>.  <math>\Delta V^{***} = V_{000} - V_{001}</math> (<math>V_{010}</math>, <math>V_{100}</math>)</p> 

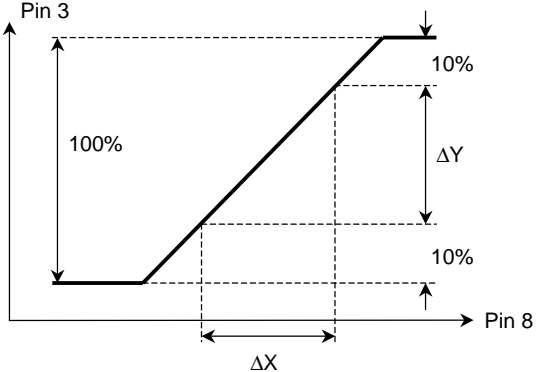
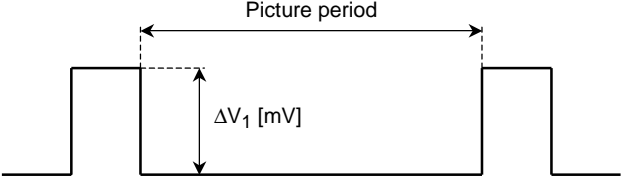
Note	Parameter	Test Conditions (unless otherwise stated, $V_{CC1} = 5\text{ V}$ , $V_{CC2}/V_{CC3}/DEF\ V_{CC} = 9\text{ V}$ , $T_a = 25 \pm 3^\circ\text{C}$ )				
		Switching Mode				Test Conditions
		SW <sub>15</sub>	SW <sub>49</sub>	SW <sub>50</sub>	SW <sub>53</sub>	
V <sub>6</sub>	D.ABL Sensitivity	C	ON	A	C	<ol style="list-style-type: none"> <li>1) Set the BUS control data to the preset value.</li> <li>2) Turn the Y mute off (1), turn the black stretch gain off (1), and connect pin 8 to an external power supply.</li> <li>3) With the D.ABL detect voltage at the minimum (000), plot the voltage characteristics of pin 3 in relation to the voltage of pin 8 when D.ABL sensitivity is at the minimum (000) and the maximum (111).</li> <li>4) From the diagram, calculate the <math>S_{DAMIN}</math> and <math>S_{DAMAX}</math> gradients.  <math>S_{DAMIN}, S_{DAMAX} = \Delta Y / \Delta X</math></li> </ol> 
V <sub>7</sub>	Black Level Compensation	↑	OFF	↑	↑	<ol style="list-style-type: none"> <li>1) Set the BUS control data to the preset value.</li> <li>2) Turn the Y mute off (1), turn the black stretch gain off (1), and observe pin 3.</li> <li>3) Turn the black level compensation on (1), measure <math>\Delta V_1</math> [mV], and calculate the following formula.  <math>B_{LC} = (\Delta V_1 / 1.4 \times 10^3) \times 100</math> (IRE)</li> </ol> 



Note	Parameter	Test Conditions (unless otherwise stated, $V_{CC1} = 5\text{ V}$ , $V_{CC2}/V_{CC3}/DEF\ V_{CC} = 9\text{ V}$ , $T_a = 25 \pm 3^\circ\text{C}$ )				Test Conditions
		Switching Mode				
		SW <sub>15</sub>	SW <sub>49</sub>	SW <sub>50</sub>	SW <sub>53</sub>	
V <sub>8</sub>	Black Peak Detect Level	C	ON	C	C	<ol style="list-style-type: none"> <li>1) Set the BUS control data to the preset value.</li> <li>2) Measure the DC voltage <math>V_{49}</math> of pin 3.</li> <li>3) Connect pin 78 to an external power supply (PS).</li> <li>4) Turn the Y mute off (1), the black stretch gain off (1), and set the black detect level shift to 0 IRE (1).</li> <li>5) Increase the PS from 0 V and measure the voltage <math>V_{BP}</math> of pin 3 where the DC level of the picture period of pin 2 shifts from high to low.</li> <li>6) Calculate <math>\Delta V_{BP}</math> from the following formula.  <math display="block">\Delta V_{BP} = V_{BP} - V_{49}</math> </li> </ol>
V <sub>9</sub>	DC Transmission Rate Compensation Gain	↑	↑	B	↑	<ol style="list-style-type: none"> <li>1) Set the BUS control data to the preset value.</li> <li>2) Turn the Y mute off (1), turn the video mute off (0), and connect pin 78 to an external power supply (PS).</li> <li>3) Measure the amplitude <math>V_{43}</math> of pin 11, set the PS to <math>V_{53} + 0.7\text{ V}</math>, and adjust <math>V_{43}</math> to <math>0.7\text{ V}_{p-p}</math> using unicolor.</li> <li>4) With the DC transmission rate compensation gain at the minimum (000), measure <math>\Delta V_1</math> and <math>\Delta V_2</math> as in the diagram below.</li> <li>5) Next, with the DC transmission rate compensation gain at the maximum (111), measure <math>\Delta V_3</math> and <math>\Delta V_4</math>.</li> <li>6) Calculate ADT100 and ADT130 from the following formula.  <math display="block">ADT100 = (\Delta V_2 [\text{V}] - \Delta V_1 [\text{V}]) \div 0.1 [\text{V}]</math> <math display="block">ADT130 = (\Delta V_4 [\text{V}] - \Delta V_3 [\text{V}]) \div 0.1 [\text{V}]</math> </li> </ol>

Note	Parameter	Test Conditions (unless otherwise stated, $V_{CC1} = 5\text{ V}$ , $V_{CC2}/V_{CC3}/DEF\ V_{CC} = 9\text{ V}$ , $T_a = 25 \pm 3^\circ\text{C}$ )				
		Switching Mode				Test Conditions
		SW <sub>15</sub>	SW <sub>49</sub>	SW <sub>50</sub>	SW <sub>53</sub>	
V <sub>10</sub>	DC Transmission Compensation Start Point	C	ON	B	C	<p>1) Repeat steps 1) and 2) of V<sub>21</sub>.</p> <p>2) Measure the amplitude V<sub>43</sub> of pin 11, set the PS to V<sub>53</sub> + 0.7 V, and adjust V<sub>43</sub> to around 1.0 V<sub>p-p</sub> using unicolor.</p> <p>3) With the DC transmission compensation rate at the minimum (000), increase PS from V<sub>53</sub> and plot the relationship between the voltages of pins 3 and 11.</p> <p>4) Next, with the DC transmission compensation rate at the maximum (111), increase PS from V<sub>53</sub> and plot the relationship between the voltages of pins 3 and 11.</p> <p>5) With the DC transmission compensation rate at the maximum (111), increase the PS from V<sub>53</sub> when the DC transmission compensation start point reaches the maximum (111) and plot the relationship between the voltages of pins 3 and 11.</p> <p>6) Calculate V<sub>DT0</sub> and V<sub>DT42</sub> from the following formula.  <math>V_{DT0} = ((V_{SP0} - V_{49})/1\text{ [V]}) \times 100\text{ [%]}</math>  <math>V_{DT42} = ((V_{SP42} - V_{49})/1\text{ [V]}) \times 100\text{ [%]}</math></p>

Note	Parameter	Test Conditions (unless otherwise stated, $V_{CC1} = 5\text{ V}$ , $V_{CC2}/V_{CC3}/DEF\ V_{CC} = 9\text{ V}$ , $T_a = 25 \pm 3^\circ\text{C}$ )				
		Switching Mode				Test Conditions
		SW <sub>15</sub>	SW <sub>49</sub>	SW <sub>50</sub>	SW <sub>53</sub>	
V <sub>11</sub>	DC Transmission Compensation Limit Point	C	ON	B	C	<p>1) Set the BUS control data to the preset value.</p> <p>2) Turn the Y mute off (1), turn the video mute off (0), and with the unicolor set at maximum (1111111), connect pin 3 to an external power supply (PS).</p> <p>3) Set the DC transmission compensation rate to the maximum (111).</p> <p>4) Increase the PS from 5 V, observe pin 11, and plot the DC transmission compensation rate.</p> <p>5) Repeat 4) above but change the DC transmission compensation limit point data. Calculate P<sub>DTL60</sub>, P<sub>DTL73</sub>, P<sub>DTL87</sub>, and P<sub>DTL100</sub> from the measured data and the following formulas.</p> $P_{DTL60} = (V_{L60} - V_{49})/1.0 \times 100 [\%]$ $P_{DTL73} = (V_{L73} - V_{49})/1.0 \times 100 [\%]$ $P_{DTL87} = (V_{L87} - V_{49})/1.0 \times 100 [\%]$ $P_{DTL100} = (V_{L100} - V_{49})/1.0 \times 100 [\%]$

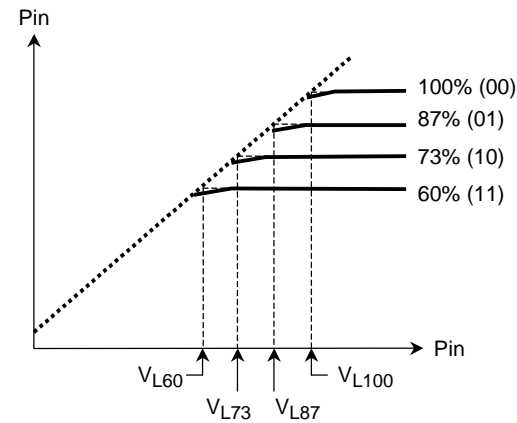

Note	Parameter	Test Conditions (unless otherwise stated, $V_{CC1} = 5\text{ V}$ , $V_{CC2}/V_{CC3}/DEF\ V_{CC} = 9\text{ V}$ , $T_a = 25 \pm 3^\circ\text{C}$ )				
		Switching Mode				Test Conditions
		SW <sub>15</sub>	SW <sub>49</sub>	SW <sub>50</sub>	SW <sub>53</sub>	
V <sub>12</sub>	Picture Sharpness Control Range	C	OFF	B	A	<ol style="list-style-type: none"> <li>1) Set the BUS control data to the preset value.</li> <li>2) Input a sine wave to TP78.</li> <li>3) Set the amplitude of pin 78 to 20 mV<sub>p-p</sub>.</li> <li>4) Set the unicolor to the maximum (1111111), set SHR tracking to SRT-gain low (11), and set the aperture compensator peak frequency to 4.2M (001).</li> <li>5) Turn the Y mute off (1), the video mute off (0), connect TP11 and TP15b, and observe TP15a.</li> <li>6) Set the picture sharpness to the maximum (1111111). When the frequencies are 100 kHz and F<sub>APL01</sub>, measure the V<sub>100</sub> and V<sub>L</sub> amplitudes respectively and calculate G<sub>MAXL</sub> by the formula shown below.</li> <li>7) Next, set the picture sharpness to the minimum (0000000). As in 6), when the frequencies are 100 kHz and 2.4 MHz, measure the V<sub>100</sub> and V<sub>L</sub> amplitudes respectively and calculate G<sub>MINL</sub> by the formula shown below.</li> <li>8) Set the aperture compensator peak frequency to 7.7M (111) and the picture sharpness to the maximum (1111111). When the frequencies are 100 kHz and F<sub>APH11</sub>, measure the V<sub>100</sub> and V<sub>H</sub> amplitudes respectively and calculate G<sub>MAXH</sub> by the formula shown below.</li> <li>9) Next, set the picture sharpness to the minimum (0000000). When the frequencies are 100 kHz and 4 MHz, measure the V<sub>100</sub> and V<sub>H</sub> amplitudes respectively and calculate G<sub>MINH</sub> by the following formula. G**** [dB] = 20 × Log (V<sub>L (H)</sub> ÷ V<sub>100</sub>)</li> </ol>
V <sub>13</sub>	YNR Characteristics	↑	↑	↑	↑	<ol style="list-style-type: none"> <li>1) Repeat steps 1) to 5) of V<sub>12</sub>.</li> <li>2) With YNR on (1) and the picture sharpness at minimum (0000000), measure the TP15a amplitudes V<sub>100</sub> and V<sub>L</sub> when the input signal frequencies are 100 kHz and 2.4 MHz respectively.</li> <li>3) Next, set the aperture compensator peak frequency to 7.7M (111). When the input signal frequencies are 100 kHz and 4 MHz, measure the V<sub>100</sub> and V<sub>H</sub> amplitudes respectively and calculate G<sub>YL</sub> and G<sub>YH</sub> by the following formula. G<sub>YL (H)</sub> [dB] = 20 × Log (V<sub>L (H)</sub> ÷ V<sub>100</sub>)</li> </ol>

Note	Parameter	Test Conditions (unless otherwise stated, $V_{CC1} = 5V$ , $V_{CC2}/V_{CC3}/DEF V_{CC} = 9V$ , $T_a = 25 \pm 3^\circ C$ )				
		Switching Mode				Test Conditions
		SW <sub>15</sub>	SW <sub>49</sub>	SW <sub>50</sub>	SW <sub>53</sub>	
V <sub>14</sub>	2T Pulse Response SRT Control	C	ON	B	A	<ol style="list-style-type: none"> <li>1) Set the BUS control data to the preset value.</li> <li>2) Input a 2T pulse (STD) signal to TP78, turn the Y mute off (1), turn the video mute off (0), set unicolor to maximum (1111111), and set SHR tracking to SRT-gain low (11).</li> <li>3) Set the sharpness control to the center (1000000), set the aperture compensator peak frequency to 4.2M (001), connect TP11 and TP15b, and observe TP15a.</li> <li>4) Measure <math>T_{SL1}</math> as in the diagram below.</li> <li>5) Set SHR tracking to SRT-gain high (00) and measure <math>T_{SL2}</math>.</li> <li>6) Next, set the aperture compensator peak frequency to 7.7M (111) and measure <math>T_{SH1}</math> and <math>T_{SH2}</math> as above.</li> <li>7) Calculate the following formula.  <math display="block">T_{SRTL} = T_{SL1} - T_{SL2}</math> <math display="block">T_{SRTH} = T_{SH1} - T_{SH2}</math> </li> </ol>

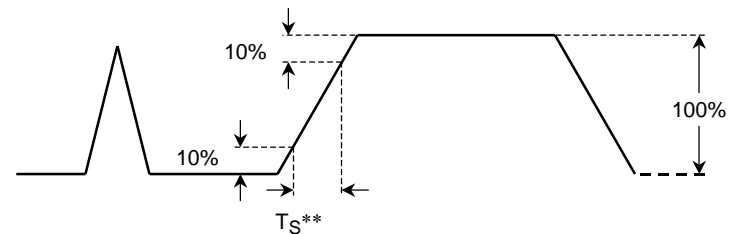

Note	Parameter	Test Conditions (unless otherwise stated, $V_{CC1} = 5\text{ V}$ , $V_{CC2}/V_{CC3}/DEF\ V_{CC} = 9\text{ V}$ , $T_a = 25 \pm 3^\circ\text{C}$ )				
		Switching Mode				Test Conditions
		SW <sub>15</sub>	SW <sub>49</sub>	SW <sub>50</sub>	SW <sub>53</sub>	
V <sub>15</sub>	VSM Gain	C	ON	B	A	<ol style="list-style-type: none"> <li>1) Set the BUS control data to the preset value.</li> <li>2) Input the frequency <math>F_{VL}</math> sine wave to TP78.</li> <li>3) Turn the Y mute off (1), turn the video mute off (0), set the aperture compensator peak frequency to 4.2M (001), and set the amplitude of pin 78 to <math>0.1\ V_{p-p}</math>.</li> <li>4) Measure the TP5 amplitudes <math>V_{L00}</math>, <math>V_{L01}</math>, <math>V_{L10}</math>, and <math>V_{L11}</math> in the following cases.  VSM gain  0dB (00) <math>\rightarrow V_{L(H) 00}</math>  -6dB (01) <math>\rightarrow V_{L(H) 01}</math>  -9dB (10) <math>\rightarrow V_{L(H) 10}</math>  OFF (11) <math>\rightarrow V_{L(H) 11}</math> </li> <li>5) Input the sine wave of frequency <math>F_{VH}</math> to TP78, set the aperture compensator peak frequency to 7.7M (111), and measure the TP5 amplitudes <math>V_{H00}</math>, <math>V_{H01}</math>, <math>V_{H10}</math>, and <math>V_{H11}</math> as above.</li> <li>6) Calculate the following formulas.  <math>G_{VL(H) 00} = 20 \times \text{Log}(V_{L(H) 00}/0.1)</math> [dB]  <math>G_{VL(H) 01} = 20 \times \text{Log}(V_{L(H) 01}/0.1)</math> [dB] - <math>20 \times \text{Log}(V_{L(H) 00}/0.1)</math> [dB]  <math>G_{VL(H) 10} = 20 \times \text{Log}(V_{L(H) 10}/0.1)</math> [dB] - <math>20 \times \text{Log}(V_{L(H) 00}/0.1)</math> [dB]  <math>G_{VL(H) 11} = 20 \times \text{Log}(V_{L(H) 11}/0.1)</math> [dB] </li> </ol>

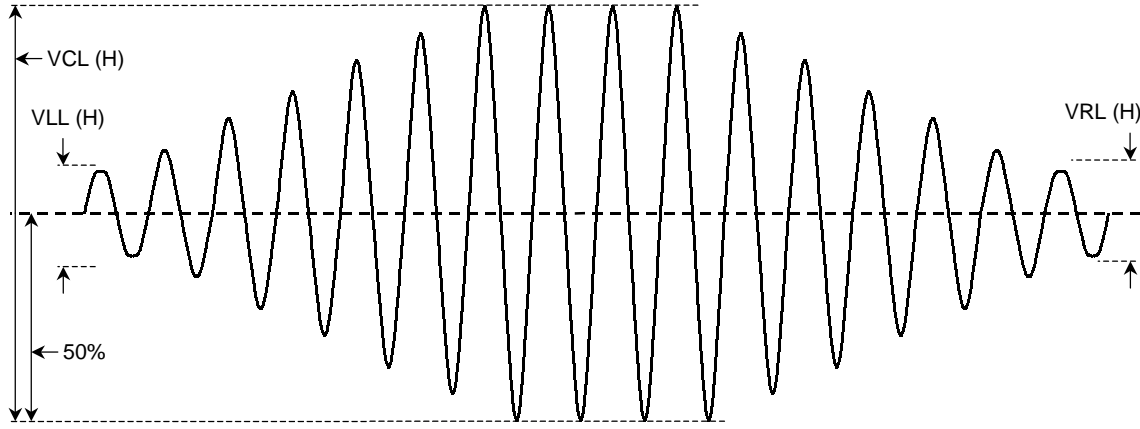
Note	Parameter	Test Conditions (unless otherwise stated, $V_{CC1} = 5\text{ V}$ , $V_{CC2}/V_{CC3}/DEF V_{CC} = 9\text{ V}$ , $T_a = 25 \pm 3^\circ\text{C}$ )				
		Switching Mode				Test Conditions
		SW <sub>15</sub>	SW <sub>49</sub>	SW <sub>50</sub>	SW <sub>53</sub>	
V <sub>16</sub>	VSM Horizontal Parabola Modulation Gain	C	ON	B	<p>A</p> <p>1) Repeat steps 1) to 3) of V<sub>15</sub>.</p> <p>2) Turn on the VSM output horizontal parabola modulation (1) and set the VSM gain to 0dB (00).</p> <p>3) As in the diagram, measure the picture period amplitudes VCL, VRL, and VLL of TP5.</p> <p>4) Next, input the sine wave of frequency F<sub>VH</sub> to TP78, set the aperture compensator peak frequency to 7.7M (111), set the VSM horizontal parabola frequency to 31.5k (10), and measure the picture period amplitudes VCH, VRH, and VLH of TP5 as above.</p> <p>5) Calculate G<sub>VRL</sub>, G<sub>VLL</sub>, G<sub>VRH</sub>, and G<sub>VLH</sub> from the following formulas.  <math>G_{VRL(H)} = 20 \times \text{Log} (VRL(H)/VCL(H))</math>  <math>G_{VLL(H)} = 20 \times \text{Log} (VLL(H)/VCL(H))</math></p>  <p>6) In 3) and 4) above, turn the VSM output horizontal parabola modulation off (0) and check that no parabola modulation is generated on the picture period signal. (VPOFL, VPOFH)</p>	

Note	Parameter	Test Conditions (unless otherwise stated, $V_{CC1} = 5\text{ V}$ , $V_{CC2}/V_{CC3}/DEF\ V_{CC} = 9\text{ V}$ , $T_a = 25 \pm 3^\circ\text{C}$ )				
		Switching Mode				Test Conditions
		SW <sub>15</sub>	SW <sub>49</sub>	SW <sub>50</sub>	SW <sub>53</sub>	
V <sub>17</sub>	VSM High-Speed Mute Response Time	C	ON	B	A	<p>1) Repeat steps 1) to 3) of V<sub>15</sub>, then observe pin 5.</p> <p>2) Input a pulse like that shown below to pin 27 and measure the response time T<sub>VML1</sub> (2) at that input.</p> <p>3) Similarly, input the pulse to pin 21 and measure the response time T<sub>VML3</sub> (4) at that input.</p> <p>4) Input the sine wave of frequency F<sub>VH</sub> to TP78, set the aperture compensator peak frequency to 7.7M (111), and measure the response time T<sub>VMH1</sub> (2) as in 2) above.</p> <p>5) Similarly, input the pulse to pin 21 and measure the response time T<sub>VMH3</sub> (4) at the input.</p>



Note	Parameter	Test Conditions (unless otherwise stated, $V_{CC1} = 5\text{ V}$ , $V_{CC2}/V_{CC3}/DEF\ V_{CC} = 9\text{ V}$ , $T_a = 25 \pm 3^\circ\text{C}$ )								
		Subaddress				Switching Mode				Test Conditions
		07	10	17	18	SW <sub>5</sub>	SW <sub>6</sub>	SW <sub>13</sub>	SW <sub>15</sub>	
	Chroma Block									Chroma block common test conditions SW <sub>13</sub> : B, SW <sub>15</sub> : C, SW <sub>18</sub> : ON, SW <sub>20</sub> : ON, SW <sub>23</sub> : ON, SW <sub>24</sub> : ON, SW <sub>25</sub> : ON, SW <sub>33</sub> : A, SW <sub>34</sub> : A, SW <sub>35</sub> : A, SW <sub>37</sub> : A, SW <sub>38</sub> : A, SW <sub>39</sub> : A, SW <sub>46</sub> : ON
C <sub>1</sub>	ACC Characteristics	80	00	00	00	OPEN	OPEN	B	A	1) Input 3.58-NTSC rainbow signal (C-4 signal) burst/chroma signals with the same burst/chroma amplitude to the chroma input pin (TP54). 2) Measure the output amplitudes F <sub>10</sub> , F <sub>30</sub> , F <sub>300</sub> , and F <sub>600</sub> of the UQ output pin 65 when the chroma input amplitude levels are set to 10, 30, 300, and 600 mV <sub>p-p</sub> . 3) Calculate $A = F_{30}/F_{300}$ .
C <sub>2</sub>	APC Frequency Control Sensitivity	↑	↑	↑	↑	↑	↑	A	↑	1) Connect SW <sub>13</sub> to A. 2) Switch the color system mode (10) to 3.58 NTSC (00), 4.43 PAL (60), and M-PAL (80) and measure the following for each of those cases. 3) Connect external voltage source (V <sub>11</sub> ) to APC filter pin 58. 4) Vary the voltage of the external voltage source (V <sub>11</sub> ) and observe the f <sub>sc</sub> output pin 72 using a frequency counter. 5) Measure the free-run sensitivity β for the V <sub>11</sub> + ΔV <sub>11</sub> (100 mV) near the f <sub>c</sub> . (3.5 NTSC = β <sub>3</sub> , 4.3; PAL = β <sub>4</sub> ; M-PAL = β <sub>M</sub> )
C <sub>3</sub>	APC Pull-In and Hold Range	↑	↑	↑	↑	↑	↑	↑	↑	1) Input 3.579545 MHz, 4.433619 MHz, and 3.575611 MHz continuous waves (200 mV <sub>p-p</sub> to the chroma input pin (TP54). 2) Switch the color system mode (10) to 3.58 NTSC (00), 4.43 PAL (60), and M-PAL (80), and measure the following for each of those cases. 3) Vary the input signal frequency in 10 Hz-steps within a range of ±3 kHz. 4) Clamp B/W → color mode (f*P*). While holding color → B/W mode (f*H*), measure the ± deviations from the frequency at each continuous wave input.
C <sub>4</sub>	SECAM Output DC Level Change	↑	C <sub>0</sub>	00 or 30 or 60	↑	↑	↑	↑	↑	1) Connect SW <sub>13</sub> to A. 2) Measure the output DC level of the SECAM control pin 3 when the color system mode (10) is switched to 3.58 NTSC (00), 4.43 PAL (30), and SECAM (60). (3.58 NTSC mode: SEN) (4.43 PAL mode: SEP) (SECAM mode: SES)

Note	Parameter	Test Conditions (unless otherwise stated, $V_{CC1} = 5\text{ V}$ , $V_{CC2}/V_{CC3}/DEF V_{CC} = 9\text{ V}$ , $T_a = 25 \pm 3^\circ\text{C}$ )								
		Subaddress				Switching Mode				Test Conditions
		07	10	17	18	SW <sub>5</sub>	SW <sub>6</sub>	SW <sub>13</sub>	SW <sub>15</sub>	
C <sub>5</sub>	NTSC Ident Sensitivity	80	C <sub>0</sub> or D <sub>0</sub>	00	00	OPEN	OPEN	B	A	<ol style="list-style-type: none"> <li>1) Input a 3.58-NTSC rainbow (C-4 signal) burst/chroma signal with the same burst/chroma amplitudes to the chroma input pin (TP54).</li> <li>2) Observe the BUS READ mode (5<sup>th</sup> and 6<sup>th</sup> bits of the 1<sup>st</sup> byte).</li> <li>3) Switch the Ident sensitivity (set the subaddress (10) data low (C<sub>0</sub>) and high (D<sub>0</sub>)) and perform the following measurements.</li> <li>4) Increase the input signal amplitude from 0 and measure the input signal amplitude at the switch to 3.58 NTSC mode. (LOW (C<sub>0</sub>): vN<sub>CL</sub>, High (D<sub>0</sub>): vN<sub>CH</sub>)</li> <li>5) Lower the input signal amplitude from 100 mV<sub>p-p</sub> and measure the input signal amplitude at the deviation from 3.58 NTSC mode. (LOW (C<sub>0</sub>): vN<sub>BL</sub>, High (D<sub>0</sub>): vN<sub>BH</sub>)</li> </ol>
C <sub>6</sub>	PAL Ident Sensitivity	↑	↑	↑	↑	↑	↑	↑	↑	<ol style="list-style-type: none"> <li>1) Input a 4.43-PAL rainbow (C-4 signal) burst/chroma signal with the same burst/chroma amplitude to the chroma input pin (TP54).</li> <li>2) Observe the BUS READ mode (5<sup>th</sup> and 6<sup>th</sup> bits of the 1<sup>st</sup> byte).</li> <li>3) Switch the Ident sensitivity (set the subaddress (10) data low (C<sub>0</sub>) and high (D<sub>0</sub>)) and perform the following measurements.</li> <li>4) Increase the input signal amplitude from 0 and measure the input signal amplitude at the switch to 4.43 PAL mode. (LOW (C<sub>0</sub>): vP<sub>CL</sub>, High (D<sub>0</sub>): vP<sub>CH</sub>)</li> <li>5) Lower the input signal amplitude from 100 mV<sub>p-p</sub> and measure the input signal amplitude at the deviation from 4.43 PAL mode. (LOW (C<sub>0</sub>): vP<sub>BL</sub>, High (D<sub>0</sub>): vP<sub>BH</sub>)</li> </ol>
C <sub>7</sub>	TOF Characteristics	↑	00 or 60	↑	38	↑	↑	↑	↑	<ol style="list-style-type: none"> <li>1) Input the signal C-1 to the chroma input pin (TP54). (signal amplitude = 50 mV<sub>p-p</sub>).</li> <li>2) When the subaddress (10) data are f<sub>0</sub> = 3.58 MHz (00) and f<sub>0</sub> = 4.43 MHz (60), and subaddress (18) data are (38), connect 1.5 kΩ between the V<sub>I</sub> output pin 6 and the 5 V-V<sub>CC</sub> and observe the V<sub>I</sub> output pin 64.</li> <li>3) Measure the output amplitude when f<sub>0</sub> = 3.58 MHz and calculate the gain in decibels from the input (GF<sub>C3</sub>).</li> <li>4) Measure the output amplitude when f<sub>0</sub> = 3.58 MHz ± 500 kHz and calculate the gain in decibels from the input (+500 kHz: GF<sub>H3</sub>, -500 kHz: GF<sub>L3</sub>).</li> <li>5) Measure the output amplitude when f<sub>0</sub> = 4.43 MHz and calculate the gain in decibels from the input (GF<sub>C4</sub>).</li> <li>6) Measure the output amplitude when f<sub>0</sub> = 4.43 MHz ± 500 kHz and calculate the gain in decibels from the input (+500 kHz: GF<sub>H4</sub>, -500 kHz: GF<sub>L4</sub>).</li> </ol>

Note	Parameter	Test Conditions (unless otherwise stated, $V_{CC1} = 5\text{ V}$ , $V_{CC2}/V_{CC3}/DEF V_{CC} = 9\text{ V}$ , $T_a = 25 \pm 3^\circ\text{C}$ )									
		Switching Mode									Test Conditions
		SW <sub>33</sub>	SW <sub>34</sub>	SW <sub>35</sub>	SW <sub>37</sub>	SW <sub>38</sub>	SW <sub>39</sub>	SW <sub>51</sub>	SW <sub>52</sub>	SW <sub>53</sub>	
	Text Block										Text block common test conditions SW <sub>13</sub> : A, SW <sub>15</sub> : C, SW <sub>18</sub> : ON, SW <sub>20</sub> : ON, SW <sub>23</sub> : ON, SW <sub>24</sub> : ON, SW <sub>25</sub> : ON
T <sub>1</sub>	AC Gain	A	A	A	A	A	A	B	B	A	1) Input signal 1 ( $f_0 = 100\text{ kHz}$ , picture period amplitude = $0.2 V_{p-p}$ ) to pin 78. 2) Measure the picture period amplitude of pins 15, 13, 11 (V <sub>41</sub> , V <sub>42</sub> , and V <sub>43</sub> ). 3) $G_R = V_{43}/0.2$ $G_G = V_{42}/0.2$ $G_B = V_{41}/0.2$
T <sub>2</sub>	Unicolor Adjustment Characteristics	↑	↑	↑	↑	↑	↑	↑	↑	↑	1) Input signal 1 ( $f_0 = 100\text{ kHz}$ , picture period amplitude = $0.2 V_{p-p}$ ) to pin 78. 2) Set the unicolor data to maximum (7F), center (40), and minimum (00) and measure the pin 11 picture period amplitudes for each case. (v <sub>u</sub> MAX, v <sub>u</sub> CNT, v <sub>u</sub> MIN) 3) Calculate the unicolor maximum and minimum amplitude ratios using digital conversion. ( $\Delta v_u$ )
T <sub>3</sub>	Brightness Adjustment Characteristics	↑	↑	↑	↑	↑	↑	↑	↑	↑	1) Input signal 2 to pin 78 and adjust the picture period amplitude output of pin 11 to $1 V_{p-p}$ . 2) Measure the voltage of pin 11 when the brightness is changed to maximum (FF), center (80), and minimum (00). (VbrMAX, VbrCNT, VbrMIN)
T <sub>4</sub>	Brightness Sensitivity	↑	↑	↑	↑	↑	↑	↑	↑	↑	1) Using the results obtained from T <sub>3</sub> , calculate the brightness sensitivity from the following formula. 2) $G_{br} = (V_{brMAX} - V_{brMIN})/256$
T <sub>5</sub>	White Peak Slice Level	↑	↑	↑	↑	↑	↑	↑	↑	↑	1) Change the bus data and set the sub-contrast to maximum. 2) Connect an external power supply to pin 78 and increase the voltage gradually from 5.8 V. 3) Measure the picture period amplitude voltage of pin 11 when pin 11's picture period is clipped (Vwps1). 4) Change the subaddress (05) data to (81) and repeat steps 1) to 3) above. (Vwps2)
T <sub>6</sub>	Black Peak Slice Level	↑	↑	↑	↑	↑	↑	↑	↑	C	1) Repeat step 1) of T <sub>5</sub> . 2) Connect an external power supply to pin 78 and decrease the voltage gradually from 5.8 V. 3) Measure the voltages of pins 11, 13, and 15 when their picture periods are clipped.

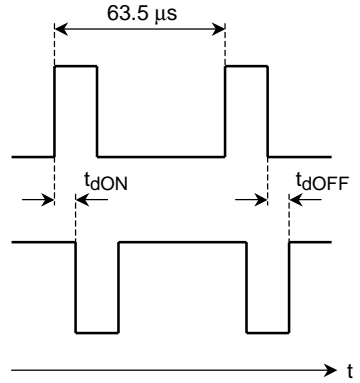
Note	Parameter	Test Conditions (unless otherwise stated, $V_{CC1} = 5\text{ V}$ , $V_{CC2}/V_{CC3}/DEF\ V_{CC} = 9\text{ V}$ , $T_a = 25 \pm 3^\circ\text{C}$ )									Test Conditions
		Switching Mode									
		SW <sub>33</sub>	SW <sub>34</sub>	SW <sub>35</sub>	SW <sub>37</sub>	SW <sub>38</sub>	SW <sub>39</sub>	SW <sub>51</sub>	SW <sub>52</sub>	SW <sub>53</sub>	
T <sub>7</sub>	Half Tone Characteristics	A	A	A	A	A	A	B	B	A	<ol style="list-style-type: none"> <li>1) Input signal 1 (<math>f_0 = 100\text{ kHz}</math>, picture period amplitude = <math>0.2\ V_{p-p}</math>) to pin 78.</li> <li>2) Measure the picture period amplitude of pin 15 (<math>V_{41A}</math>).</li> <li>3) Apply 1.5 V from an external power supply to pin 6.</li> <li>4) Measure the picture period amplitude of pin 15 (<math>V_{41B}</math>).</li> <li>5) <math>G_{HT1} = V_{41B}/V_{41A}</math></li> <li>6) Halt the voltage applied to pin 6, set the subaddress (03) data to (81), and measure the picture period amplitude of pin 15 (<math>V_{41C}</math>).</li> <li>7) <math>G_{HT2} = V_{41C}/V_{41A}</math></li> </ol>
T <sub>8</sub>	BLK Pulse Delay Time	↑	↑	↑	↑	↑	↑	↑	↑	C	<ol style="list-style-type: none"> <li>1) Calculate <math>t_{dON}</math>, <math>t_{dOFF}</math> from the signal applied to pin 25 (H.BLK input) (A below) and the output signals from pins 11, 13, and 15 (B below). (A) Signal applied to pin 25</li> </ol>  <p>(B) Output signals from pins 11, 13, 15</p>
T <sub>9</sub>	RGB Output Voltage	↑	↑	↑	↑	↑	↑	↑	↑	↑	<ol style="list-style-type: none"> <li>1) Measure the picture period voltages for pins 11, 13, and 15.</li> </ol>
T <sub>10</sub>	Cutoff Voltage Variable Range	↑	↑	↑	↑	↑	↑	↑	↑	↑	<ol style="list-style-type: none"> <li>1) Set the subaddress (17) data to (07).</li> <li>2) Measure the picture period voltage of pin 11 when the cutoff (subaddress 0C) data are changed to maximum (FF), center (80), and minimum (00), and calculate the amount of change of maximum and minimum from the center. (<math>CUT+</math>, <math>CUT-</math>).</li> <li>3) In steps 1) and 2) above, make the following changes and remeasure: Change the subaddress (0D) data and measure pin 13, Change the subaddress (0E) data and measure pin 15.</li> </ol>

Note	Parameter	Test Conditions (unless otherwise stated, $V_{CC1} = 5\text{ V}$ , $V_{CC2}/V_{CC3}/DEF V_{CC} = 9\text{ V}$ , $T_a = 25 \pm 3^\circ\text{C}$ )									
		Switching Mode									Test Conditions
		SW <sub>33</sub>	SW <sub>34</sub>	SW <sub>35</sub>	SW <sub>37</sub>	SW <sub>38</sub>	SW <sub>39</sub>	SW <sub>51</sub>	SW <sub>52</sub>	SW <sub>53</sub>	
T <sub>11</sub>	Drive Adjustment Variable Range	A	A	A	A	A	A	B	B	A	1) Input signal 1 ( $f_0 = 100\text{ kHz}$ , picture period amplitude = $0.2 V_{p-p}$ ) to pin 78. 2) Measure the picture period amplitude of pin 13 when the drive (subaddress-09) data are changed to maximum (FE), center (80), and minimum (00). 3) Calculate the maximum and minimum amplitude ratios for the drive center using decibel conversion. (DRG+, DRG-) 4) In steps 1) to 3) above, change the subaddress (0A) data, measure pin 15, and repeat the calculations. (DRB+, DRB-) 5) In steps 1) to 3) above, set data of the LSB of subaddress (09) to 1, measure pin 11, and repeat the calculations. (DRR+, DRR-)
T <sub>12</sub>	Output Voltage During Muting	↑	↑	↑	↑	↑	↑	↑	↑	C	1) Set the subaddress (00) data to (FF). 2) Measure the picture period voltages of pins 11, 13, and 15. (MURD, MUGD, MUBD)
T <sub>13</sub>	Output Voltage at Blue Back	↑	↑	↑	↑	↑	↑	↑	↑	↑	1) Set the subaddress (10) data to (08). 2) Measure the picture period voltages of pins 11 and 13 and the picture period amplitude of pin 15. (BB <sub>R</sub> , BB <sub>G</sub> , BB <sub>B</sub> )
T <sub>14</sub>	ACL Characteristics	↑	↑	↑	↑	↑	↑	↑	↑	A	1) Input signal 1 ( $f_0 = 100\text{ kHz}$ , picture period amplitude = $0.2 V_{p-p}$ ) to pin 78. 2) Measure the picture period amplitude of pin 11 ( $V_{ACL1}$ ). 3) Measure the picture period amplitude of pin 11 when $-0.5\text{ V DC}$ is applied to pin 8 from an external power supply. ( $V_{ACL2}$ ) 4) Measure the picture period amplitude of pin 11 when $-1\text{ V DC}$ is applied to pin 8 from an external power supply. ( $V_{ACL3}$ ) 5) $ACL1 = -20 \times \log(V_{ACL2}/V_{ACL1})$ $ACL2 = -20 \times \log(V_{ACL3}/V_{ACL1})$

Note	Parameter	Test Conditions (unless otherwise stated, $V_{CC1} = 5\text{ V}$ , $V_{CC2}/V_{CC3}/DEF\ V_{CC} = 9\text{ V}$ , $T_a = 25 \pm 3^\circ\text{C}$ )									
		Switching Mode									Test Conditions
		SW <sub>33</sub>	SW <sub>34</sub>	SW <sub>35</sub>	SW <sub>37</sub>	SW <sub>38</sub>	SW <sub>39</sub>	SW <sub>51</sub>	SW <sub>52</sub>	SW <sub>53</sub>	
T <sub>15</sub>	ABL Point	A	A	A	A	A	A	B	B	C	1) Measure the DC voltage of pin 8. (VABL1) 2) Set the subaddress (16) data to (1C). 3) Applying external voltage to pin 8, lower the pin voltage from 6.5 V. Measure the voltage of pin 8 when the voltage of pin 11 starts to change. (VABL2) 4) Change the data of subaddress (16) to (3C), (5C), (7C), (9C), (BC), (DC), and (FC), and repeat step 3) for each of these data. (VABL3, VABL4, VABL5, VABL6, VABL7, VABL8, VABL9) 5) $ABL_{P1} = VABL2 - VABL1$ , $ABL_{P5} = VABL6 - VABL1$ $ABL_{P2} = VABL3 - VABL1$ , $ABL_{P6} = VABL7 - VABL1$ $ABL_{P3} = VABL4 - VABL1$ , $ABL_{P7} = VABL8 - VABL1$ $ABL_{P4} = VABL5 - VABL1$ , $ABL_{P8} = VABL9 - VABL1$
T <sub>16</sub>	ABL Gain	↑	↑	↑	↑	↑	↑	↑	↑	↑	1) Apply 6.5 V from an external power supply to pin 8. 2) Set the subaddress (16) data to (00). Set the brightness to the maximum. 3) Measure the voltage of pin 11. (VABL10) 4) Apply 4.5 V from an external power supply to pin 8. 5) Change the data of subaddress (16) to (00), (04), (08), (0C), (10), (14), (18), and (1C), and repeat step 3) for each of these data. (VABL11, VABL12, VABL13, VABL14, VABL15, VABL16, VABL17, VABL18) 6) $ABL_{G1} = VABL11 - VABL10$ , $ABL_{G5} = VABL15 - VABL10$ $ABL_{G2} = VABL12 - VABL10$ , $ABL_{G6} = VABL16 - VABL10$ $ABL_{G3} = VABL13 - VABL10$ , $ABL_{G7} = VABL17 - VABL10$ $ABL_{G4} = VABL14 - VABL10$ , $ABL_{G8} = VABL18 - VABL10$
T <sub>17</sub>	RGB Output Mode	↑	↑	↑	↑	↑	↑	↑	↑	↑	1) Adjust the brightness so that the picture period voltage of pin 11 is set to 2.5 V. 2) Set the subaddress (16) data to (01). 3) Measure the picture period voltages of pins 11, 13, and 15. (V43 <sub>R</sub> , V42 <sub>R</sub> , V41 <sub>R</sub> ) 4) Change the subaddress (16) data to (02) and repeat step 3). (V43 <sub>G</sub> , V42 <sub>G</sub> , V41 <sub>G</sub> ) 5) Change the subaddress (16) data to (03) and repeat step 3). (V43 <sub>B</sub> , V42 <sub>B</sub> , V41 <sub>B</sub> )

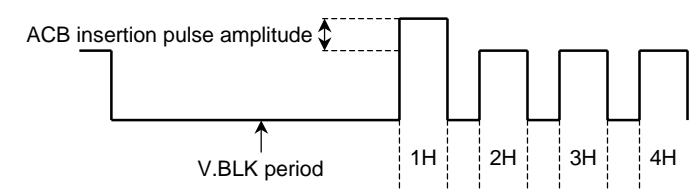
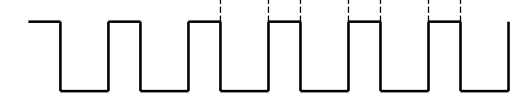
Note	Parameter	Test Conditions (unless otherwise stated, $V_{CC1} = 5\text{ V}$ , $V_{CC2}/V_{CC3}/DEF\ V_{CC} = 9\text{ V}$ , $T_a = 25 \pm 3^\circ\text{C}$ )										
		Switching Mode										Test Conditions
		SW <sub>33</sub>	SW <sub>34</sub>	SW <sub>35</sub>	SW <sub>37</sub>	SW <sub>38</sub>	SW <sub>39</sub>	SW <sub>51</sub>	SW <sub>52</sub>	SW <sub>53</sub>		
T <sub>18</sub>	ACB Insertion Pulse Phase and Amplitude	A	A	A	A	A	A	B	B	A or C	<p>1) Input signal 1 (<math>f_0 = 100\text{ kHz}</math>, picture period amplitude = <math>0.2\ V_{p-p}</math>) to pin 78 and adjust the drive adjustment data so that the picture period amplitudes of pins 13 and 15 are equal to that of pin 11.</p> <p>2) Set SW<sub>53</sub> to C.</p> <p>3) Measure the voltages of pins 31, 32, and 74. From an external power supply, apply the measured voltages to these pins.</p> <p>4) Set subaddress (15) data to (D<sub>2</sub>).</p> <p>5) From pins 11, 13, and 15, calculate the phase of the ACB insertion pulse in accordance with Figure 2 below.</p> <p>Note 5: After the completion of V.BLK, the video period following the falling edge of the FBP input is regarded as 1H and the periods at each completion of H.BLK are counted as 2H, 3H, 4H...</p> <p>6) Measure the ACB insertion pulse amplitude (the level from the picture period amplitude at no input) of pins 11, 13, and 15.</p>  <p><b>Figure 2 RGB Output</b></p>  <p><b>Figure 3 FBP Input (No.38)</b></p>	

Note	Parameter	Test Conditions (unless otherwise stated, $V_{CC1} = 5\text{ V}$ , $V_{CC2}/V_{CC3}/DEF\ V_{CC} = 9\text{ V}$ , $T_a = 25 \pm 3^\circ\text{C}$ )									Test Conditions	
		Switching Mode										
		SW <sub>33</sub>	SW <sub>34</sub>	SW <sub>35</sub>	SW <sub>37</sub>	SW <sub>38</sub>	SW <sub>39</sub>	SW <sub>51</sub>	SW <sub>52</sub>	SW <sub>53</sub>		
T <sub>19</sub>	RGB $\gamma$ Characteristics	A	A	A	A	A	A	A	B	B	A	<ol style="list-style-type: none"> <li>1) Input a ramp waveform to pin 78 and adjust the input amplitude so that the picture period amplitude of pin 11 is <math>2.3\ V_{p-p}</math>.</li> <li>2) Adjust the drive adjustment data so that the picture period amplitudes of pins 13 and 15 are equal to that of pin 11.</li> <li>3) Set the subaddress (14) data to (10).</li> <li>4) From pins 13, 15, and 11, calculate the RGB <math>\gamma</math> start point and its gradient (decibel conversion) in relation to the off point in accordance with Figure 2.</li> </ol>
T <sub>20</sub>	Analog RGB Gain	A or B	A or B	A or B	↑	↑	↑	↑	↑	↑	<ol style="list-style-type: none"> <li>1) Input signal 1 (<math>f_0 = 100\text{ kHz}</math>, picture period amplitude = <math>0.2\ V_{p-p}</math>) to pin 78 and adjust the drive adjustment data so that the picture period amplitudes of pins 13 and 15 are equal to that of pin 11.</li> <li>2) Apply 5 V from an external power supply to pin 27.</li> <li>3) Input signal 1 (<math>f_0 = 100\text{ kHz}</math>, picture period amplitude = <math>0.2\ V_{p-p}</math>) to pin 22.</li> <li>4) Measure the picture period amplitude of pin 11. (<math>V_{43R}</math>)</li> <li>5) As in steps 2) and 3) above, input to pin 24 and measure pin 13, then input to pin 25 and measure pin 15. (<math>V_{42G}</math>, <math>V_{41B}</math>)</li> <li>6) <math>G_{TXR} = V_{43R}/0.2</math>  <math>G_{TXG} = V_{42G}/0.2</math>  <math>G_{TXB} = V_{41B}/0.2</math></li> </ol>	



Note	Parameter	Test Conditions (unless otherwise stated, $V_{CC1} = 5\text{ V}$ , $V_{CC2}/V_{CC3}/\text{DEF } V_{CC} = 9\text{ V}$ , $T_a = 25 \pm 3^\circ\text{C}$ )									
		Switching Mode									Test Conditions
		SW <sub>33</sub>	SW <sub>34</sub>	SW <sub>35</sub>	SW <sub>37</sub>	SW <sub>38</sub>	SW <sub>39</sub>	SW <sub>51</sub>	SW <sub>52</sub>	SW <sub>53</sub>	
T <sub>21</sub>	Analog RGB White Peak Slice Level	A	A	A	A	A	A	B	B	A	<ol style="list-style-type: none"> <li>Repeat step 1) of T<sub>20</sub>.</li> <li>Apply 5 V from an external power supply to pin 27.</li> <li>Set the RGB contrast data to the maximum (7F).</li> <li>Connect an external power supply to pin 22, increase the voltage gradually from 3.0 V, and measure the picture period amplitude voltage when pin 11 is clipped.</li> <li>As in steps 3) and 4) above, input to pin 24 and measure pin 13, then input to pin 25 and measure pin 15.</li> </ol>
T <sub>22</sub>	Analog RGB Black Peak Limiter Level	↑	↑	↑	↑	↑	↑	↑	↑	↑	<ol style="list-style-type: none"> <li>Repeat step 1) of T<sub>20</sub>.</li> <li>Apply 5 V from an external power supply to pin 27.</li> <li>Set the RGB contrast data to the maximum (7F).</li> <li>Connect an external power supply to pin 22, decrease the voltage gradually from 4.5 V, and measure the voltage when pin 11 is clipped.</li> <li>As in steps 3) and 4) above, input to pin 24 and measure pin 13, then input to pin 25 and measure pin 15.</li> </ol>
T <sub>23</sub>	RGB Contrast Adjustment Characteristics	A or B	A or B	A or B	↑	↑	↑	↑	↑	↑	<ol style="list-style-type: none"> <li>Repeat step 1) of T<sub>20</sub>.</li> <li>Apply 5 V from an external power supply to pin 27.</li> <li>Input signal 1 (<math>f_0 = 100\text{ kHz}</math>, picture period amplitude = <math>0.2 V_{p-p}</math>) to pin 22.</li> <li>Measure the picture period amplitude of pin 11 when the RGB contrast data change to the maximum (7F), the center (40), and the minimum (00). (<math>v_{\text{TXRMAX}}</math>, <math>v_{\text{TXRCONT}}</math>, <math>v_{\text{TXRMIN}}</math>)</li> <li>Calculate the maximum and minimum amplitude ratios using decibel conversion. (DRG+, DRG-)</li> <li>As in steps 3), 4) and 5) above, input to pin 24 and measure pin 13, then input to pin 25 and measure pin 15.</li> </ol>

Note	Parameter	Test Conditions (unless otherwise stated, $V_{CC1} = 5\text{ V}$ , $V_{CC2}/V_{CC3}/DEF V_{CC} = 9\text{ V}$ , $T_a = 25 \pm 3^\circ\text{C}$ )									
		Switching Mode									Test Conditions
		SW <sub>33</sub>	SW <sub>34</sub>	SW <sub>35</sub>	SW <sub>37</sub>	SW <sub>38</sub>	SW <sub>39</sub>	SW <sub>51</sub>	SW <sub>52</sub>	SW <sub>53</sub>	
T <sub>24</sub>	Analog RGB Brightness Adjustment Characteristics	A or B	A or B	A or B	A	A	A	B	B	A	1) Repeat step 1) of T <sub>20</sub> . 2) Input signal 2 to pins 22, 24, and 25. 3) Apply 5 V from an external power supply to pin 27. 4) Adjust the signal 2 amplitude A so that the picture period amplitude of pin 11 is 0.5 V <sub>p-p</sub> . 5) Measure the picture period voltage of pins 11, 13, and 15 when the RGB brightness change to the maximum (7F), the center (40), and the minimum (00). (VbrTX <sub>MAX</sub> , VbrTX <sub>CNT</sub> , VbrTX <sub>MIN</sub> )
T <sub>25</sub>	Analog RGB Brightness Sensitivity	↑	↑	↑	↑	↑	↑	↑	↑	↑	1) Using the results obtained from T <sub>24</sub> , calculate the RGB brightness sensitivity for pins 11, 13, and 15. 2) $GbrTX = (VbrTX_{MAX} - VbrTX_{MIN})/128$
T <sub>26</sub>	Text ACL Characteristics	A	A	B	↑	↑	↑	↑	↑	↑	1) Repeat step 1) of T <sub>20</sub> . 2) Apply 5 V from an external power supply to pin 27. 3) Input signal 1 ( $f_0 = 100\text{ kHz}$ , picture period amplitude = 0.2 V <sub>p-p</sub> ) to pin 22. 4) Measure the picture period amplitude of pin 11. (V <sub>TXACL1</sub> ) 5) Measure the picture period amplitude of pin 11 when -0.5 V DC is applied to pin 8 from an external source. (V <sub>TXACL2</sub> ) 6) Measure the picture period amplitude of pin 11 when -1 V DC is applied to pin 8 from an external source. (V <sub>TXACL3</sub> ) 7) $TXACL1 = -20 \times \log(V_{TXACL2}/V_{TXACL1})$ $TXACL2 = -20 \times \log(V_{TXACL3}/V_{TXACL1})$ 8) Set the subaddress (10) data to (01) and repeat the calculations in steps 5) and 6). (TXACL3, TXACL4)

Note	Parameter	Test Conditions (unless otherwise stated, $V_{CC1} = 5\text{ V}$ , $V_{CC2}/V_{CC3}/DEF\ V_{CC} = 9\text{ V}$ , $T_a = 25 \pm 3^\circ\text{C}$ )									
		Switching Mode									Test Conditions
		SW <sub>33</sub>	SW <sub>34</sub>	SW <sub>35</sub>	SW <sub>37</sub>	SW <sub>38</sub>	SW <sub>39</sub>	SW <sub>51</sub>	SW <sub>52</sub>	SW <sub>53</sub>	
T <sub>27</sub>	Analog OSD Gain	A	A	A	A or B	A or B	A or B	B	B	A	1) Input signal 1 ( $f_0 = 100\text{ kHz}$ , picture period amplitude = $0.2\ V_{p-p}$ ) to pin 78 and adjust the drive adjustment data so that the picture period amplitudes of pins 13 and 15 are equal to that of pin 11. 2) Apply 5 V from an external power supply to pin 21. 3) Input signal 1 ( $f_0 = 100\text{ kHz}$ , picture period amplitude = $0.2\ V_{p-p}$ ) to pin 18. 4) Measure the picture period amplitude of pin 11. ( $V_{43R}$ ) 5) As in steps 3) and 4) above, input to pin 19 and measure pin 13, then input to pin 20 and measure pin 15. ( $V_{42G}$ , $V_{41B}$ ) 6) $GOSD_R = V_{43R}/0.2$ $GOSD_G = V_{42G}/0.2$ $GOSD_B = V_{41B}/0.2$
T <sub>28</sub>	Analog OSD White Peak Slice Level	↑	↑	↑	A	A	A	↑	↑	↑	1) Repeat step 1) of T <sub>27</sub> . 2) Apply 5 V from an external power supply to pin 21. 3) Apply external voltage to pin 18, increase the voltage gradually from 0.0 V, and measure the picture period amplitude voltage when pin 11 is clipped. ( $V_{OSD1R}$ ) 4) As in step 3) above, input to pin 19 and measure pin 13. Input to pin 20 and measure pin 15. 5) Set the subaddress (10) data to (04) and repeat the measurements in steps 3) and 4). ( $V_{OSD2R}$ , $V_{OSD2G}$ , $V_{OSD2B}$ )
T <sub>29</sub>	Analog OSD Black Peak Limiter Level	↑	↑	↑	↑	↑	↑	↑	↑	↑	1) Repeat step 1) of T <sub>27</sub> . 2) Apply 5 V from an external power supply to pin 21. 3) Apply external voltage to pin 18, decrease the voltage gradually from 4.5 V, and measure the voltage when pin 11 is clipped. 4) As in step 3) above, input to pin 19 and measure pin 13. Input to pin 20 and measure pin 15.
T <sub>30</sub>	Analog OSD Output DC Voltage	↑	↑	↑	↑	↑	↑	↑	↑	↑	1) Repeat step 1) of T <sub>27</sub> . 2) Apply 5 V from an external power supply to pin 21. 3) Measure the picture period voltages of pins 11, 13, and 15. ( $V_{OSDDCR}$ , $V_{OSDDCG}$ , $V_{OSDDCB}$ )

Note	Parameter	Test Conditions (unless otherwise stated, $V_{CC1} = 5\text{ V}$ , $V_{CC2}/V_{CC3}/DEF\ V_{CC} = 9\text{ V}$ , $T_a = 25 \pm 3^\circ\text{C}$ )									
		Switching Mode									Test Conditions
		SW <sub>33</sub>	SW <sub>34</sub>	SW <sub>35</sub>	SW <sub>37</sub>	SW <sub>38</sub>	SW <sub>39</sub>	SW <sub>51</sub>	SW <sub>52</sub>	SW <sub>53</sub>	
T <sub>31</sub>	OSD ACL Characteristics	A	A	A	A	A	B	B	B	A	1) Repeat step 1) of T <sub>27</sub> . Set the subaddress (10) data to (02). 2) Apply 5 V from an external power supply to pin 21. 3) Input signal 1 ( $f_0 = 100\text{ kHz}$ , picture period amplitude = $0.2\ V_{p-p}$ ) to pin 18. 4) Measure the picture period amplitude of pin 11. (VOSDACL1) 5) Measure the picture period amplitude of pin 11 when $-0.5\text{ V DC}$ is applied to pin 8 from an external source. (VOSDACL2) 6) Measure the picture period amplitude of pin 11 when $-1\text{ V DC}$ is applied to pin 8 from an external source. (VOSDACL3) 7) $OSDACL1 = -20 \times \log(VOSDACL2/VOSDACL1)$ $OSDACL2 = -20 \times \log(VOSDACL3/VOSDACL1)$ 8) Change the subaddress (10) data to (00) and repeat the measurements in steps 1) to 7). (OSDACL3, OSDACL4)

Note	Parameter	Test Conditions (unless otherwise stated, $V_{CC1} = 5\text{ V}$ , $V_{CC2}/V_{CC3}/DEF\ V_{CC} = 9\text{ V}$ , $T_a = 25 \pm 3^\circ\text{C}$ )									
		Switching Mode									Test Conditions
		SW <sub>33</sub>	SW <sub>34</sub>	SW <sub>35</sub>	SW <sub>37</sub>	SW <sub>38</sub>	SW <sub>39</sub>	SW <sub>51</sub>	SW <sub>52</sub>	SW <sub>53</sub>	
	Color Difference Block										Color difference block common test conditions SW <sub>13</sub> : A, SW <sub>15</sub> : C, SW <sub>18</sub> : ON, SW <sub>20</sub> : ON, SW <sub>23</sub> : ON, SW <sub>24</sub> : ON, SW <sub>25</sub> : ON
A <sub>1</sub>	Color Difference Contrast Adjustment Characteristics	A	A	A	A	A	A	A or B	A or B	C	<ol style="list-style-type: none"> <li>1) Change the G and B drive data to the value resulting from the adjustment in step 1) of T<sub>20</sub>.</li> <li>2) Set the brightness to maximum, set the subaddress (0F) data to (30), and set the subaddress (10) data to (20).</li> <li>3) Input signal 3 (<math>f_0 = 100\text{ kHz}</math>, picture period amplitude = <math>0.23\text{ V}_{p-p}</math>) to pin 1.</li> <li>4) Measure the picture period amplitude of pin 11 when the unicolor data change to the maximum (7F), the center (40), and the minimum (00). (<math>v_{uCY_{MAX}}</math>, <math>v_{uCY_{CNT}}</math>, <math>v_{uCY_{MIN}}</math>)</li> <li>5) Calculate the unicolor maximum and minimum amplitude ratios using decibel conversion. (<math>\Delta v_{uCY}</math>)</li> <li>6) Repeat steps 3), 4), and 5) above, inputting the picture period amplitude <math>0.2\text{ V}_{p-p}</math> to pin 80 and measuring pin 15.</li> </ol>
A <sub>2</sub>	Color Adjustment Characteristics	↑	↑	↑	↑	↑	↑	↑	↑	↑	<ol style="list-style-type: none"> <li>1) Measure the voltage of pin 1. Set the brightness to maximum, set the subaddress (0F) data to (30), and set the subaddress (10) data to (20).</li> <li>2) Input signal 3 (<math>f_0 = 100\text{ kHz}</math>, picture period amplitude = <math>0.115\text{ V}_{p-p}</math>) to pin 1.</li> <li>3) Measure the picture period amplitude of pin 11 when the color data are changed to the maximum (7F), the center (40), and the minimum (01). (<math>v_{cCY_{MAX}}</math>, <math>v_{cCY_{CNT}}</math>, <math>v_{cCY_{MIN}}</math>)</li> <li>4) Calculate the color maximum and minimum amplitude ratios for the center using decibel conversion. (<math>\Delta v_{cCY+}</math>, <math>\Delta v_{cCY-}</math>)</li> <li>5) Repeat steps 2) to 4) above, inputting the picture period amplitude <math>0.1\text{ V}_{p-p}</math> to pin 80 and measuring pin 15.</li> </ol>

Note	Parameter	Test Conditions (unless otherwise stated, $V_{CC1} = 5\text{ V}$ , $V_{CC2}/V_{CC3}/DEF\ V_{CC} = 9\text{ V}$ , $T_a = 25 \pm 3^\circ\text{C}$ )									
		Switching Mode									Test Conditions
		SW <sub>33</sub>	SW <sub>34</sub>	SW <sub>35</sub>	SW <sub>37</sub>	SW <sub>38</sub>	SW <sub>39</sub>	SW <sub>51</sub>	SW <sub>52</sub>	SW <sub>53</sub>	
A <sub>3</sub>	Color Difference Half Tone Characteristics	A	A	A	A	A	A	A or B	A or B	C	1) Set the subaddress (10) data to (20). 2) Input signal 3 ( $f_0 = 100\text{ kHz}$ , picture period amplitude = $0.2\ V_{p-p}$ ) to pin 1. 3) Measure the picture period amplitude of the waveform output from pin 11. ( $vHTA_{RY}$ ) 4) Apply 1.5 V from an external power supply to pin 6. 5) Measure the picture period amplitude of the waveform output from pin 11. ( $vHTB_{RY}$ ) 6) $GHT_{RY} = vHTB_{RY}/vHTA_{RY}$ 7) Repeat steps 1) to 5) above with pin 13. $GHT_{GY} = vHTB_{GY}/vHTA_{GY}$ 8) Repeat steps 1) to 5) above, inputting signal to pin 80 and measuring pin 15. $GHT_{BY} = vHTB_{BY}/vHTA_{BY}$

Note	Parameter	Test Conditions (unless otherwise stated, $V_{CC1} = 5\text{ V}$ , $V_{CC2}/V_{CC3}/DEF\ V_{CC} = 9\text{ V}$ , $T_a = 25 \pm 3^\circ\text{C}$ )									
		Switching Mode									Test Conditions
		SW <sub>33</sub>	SW <sub>34</sub>	SW <sub>35</sub>	SW <sub>37</sub>	SW <sub>38</sub>	SW <sub>39</sub>	SW <sub>51</sub>	SW <sub>52</sub>	SW <sub>53</sub>	
A <sub>4</sub>	Color $\gamma$ Characteristics	A	A	A	A	A	A	B	B	C	<ol style="list-style-type: none"> <li>1) Set the subaddress (10) data to (20).</li> <li>2) Input signal 2 to pin 1.</li> <li>3) When the subaddress (07) data are:                      (80) – <math>\gamma</math>OFF                      (82) – <math>\gamma</math>1ON                      (84) – <math>\gamma</math>2ON                      (86) – <math>\gamma</math>3ON                      measure the changes in the amplitude level of the pin 43 output signal at an increase the amplitude A of signal 2 and plot the characteristics.</li> <li>4) Calculate the <math>\gamma</math>ON gradient <math>\Delta</math>, using <math>V_\gamma</math>, which represents the point at which the <math>\gamma</math> characteristics become effective, and the gradient of the linear section with <math>\gamma</math>OFF as (1).</li> </ol>
A <sub>5</sub>	Color Limiter Characteristics	↑	↑	↑	↑	↑	↑	↑	A	↑	<ol style="list-style-type: none"> <li>1) Measure the voltage of pin 1.</li> <li>2) Set the subaddress (10) data to (20).</li> <li>3) Input signal 2 (picture period amplitude = <math>0.4\ V_{p-p}</math>) to pin 80.</li> <li>4) Measure the picture period amplitude of the pin 11 output signal when the subaddress (07) data are (80) and (81). (CLT0, CLT1)</li> </ol>



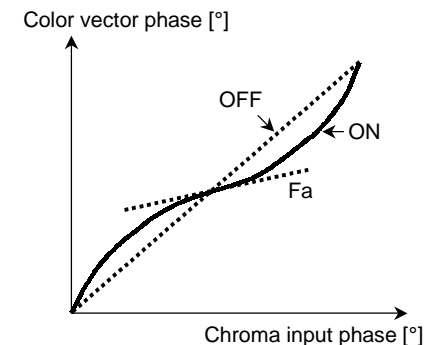

Note	Parameter	Test Conditions (unless otherwise stated, $V_{CC1} = 5\text{ V}$ , $V_{CC2}/V_{CC3}/DEF\ V_{CC} = 9\text{ V}$ , $T_a = 25 \pm 3^\circ\text{C}$ )									Test Conditions
		Switching Mode									
		SW <sub>33</sub>	SW <sub>34</sub>	SW <sub>35</sub>	SW <sub>37</sub>	SW <sub>38</sub>	SW <sub>39</sub>	SW <sub>51</sub>	SW <sub>52</sub>	SW <sub>53</sub>	
A <sub>6</sub>	High-Brightness Color Gain	A	A	A	A	A	A	B	A	C	1) Set subaddress (10) data to (20). 2) Input signal 2 (picture period amplitude = $0.2\ V_{p-p}$ ) to pin 80. 3) Adjust the color control so that the picture period amplitude output from pin 15 is $1.2\ V_{p-p}$ . 4) Measure the picture period amplitude of the pin 15 output signal when the subaddress (06) data are (FF). ( $V_{41}$ ) 5) $HBC1 = (1.2 - V_{41})/1.2$
A <sub>7</sub>	Flesh Color Characteristics	↑	↑	↑	↑	↑	↑	A	↑	↑	1) Input IQ demodulated flesh-bar signals ( $15^\circ$ -step rainbow signals in the range $-30^\circ$ to $+240^\circ$ ) to pin 80 (Q signal) and pin 1 (I signal) as $0.2\ V_{p-p}$ . Set the brightness to maximum. 2) Set subaddress (10) data to (00). 3) Measure the signals output from pins 11 and 15 and switch to subaddress (10) data to (06). Measure the output signals and calculate the variation characteristics of the color vector phase. 4) Draw the vector variation characteristics curve showing the on state from the off state and calculate the gradient in the vicinity of the I axis as Fa33. Subaddress (08) Data (80) off Data (81) on



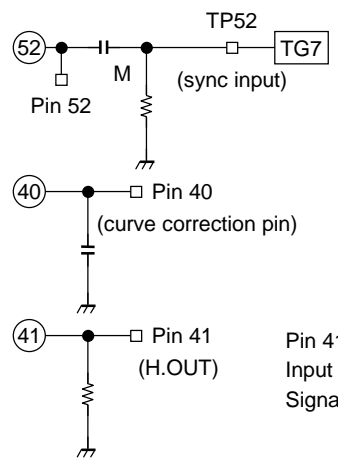

Note	Parameter	Test Conditions (unless otherwise stated, $V_{CC1} = 5\text{ V}$ , $V_{CC2}/V_{CC3}/DEF\ V_{CC} = 9\text{ V}$ , $T_a = 25 \pm 3^\circ\text{C}$ )									
		Switching Mode									Test Conditions
		SW <sub>33</sub>	SW <sub>34</sub>	SW <sub>35</sub>	SW <sub>37</sub>	SW <sub>38</sub>	SW <sub>39</sub>	SW <sub>51</sub>	SW <sub>52</sub>	SW <sub>53</sub>	
A <sub>8</sub>	Color Detail Emphasis	A	A	A	A	A	A	A	B	A	1) Connect SG to Y-IN and input a 4 MHz frequency sine wave at 20 mV <sub>p-p</sub> . 2) Set the subaddress (02) data to (01). 3) Set the subaddress (10) data to (20). 4) Set the subaddress (11) data to (02). 5) Read the 4 MHz amplitude output to pin 11. (V <sub>CDE0</sub> ) 6) Input signal 2 (picture period amplitude = 0.3 V <sub>p-p</sub> ) to pin 1. 7) Set the subaddress (02) data to (81). 8) Read the 4 MHz amplitude output to pin 11. (V <sub>CDE1</sub> ) (mV <sub>p-p</sub> ) 9) Set the subaddress (0A) data to (81) and read the amplitude of frequency Fp output to pin 11. (V <sub>CDE2</sub> ) (mV <sub>p-p</sub> ) 10) $GCD0 = 20 \times \log ( V_{CDE1} - V_{CDE0} /20)$ $GCD1 = 20 \times \log ( V_{CDE2} - V_{CDE0} /20)$

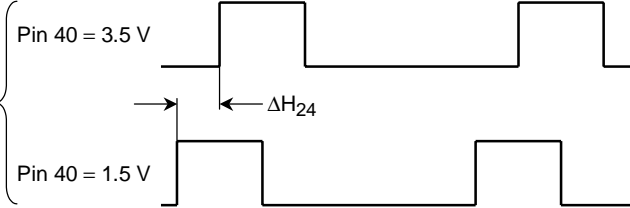
Note	Parameter	Test Conditions (unless otherwise stated, $V_{CC1} = 5\text{ V}$ , $V_{CC2}/V_{CC3}/\text{DEF } V_{CC} = 9\text{ V}$ , $T_a = 25 \pm 3^\circ\text{C}$ )						Test Conditions
		Switching Mode						
		SW <sub>16</sub>	SW <sub>17</sub>	SW <sub>18</sub>	SW <sub>20</sub>	SW <sub>23</sub>	SW <sub>25</sub>	
	DEF Block							DEF Block common test conditions SW <sub>13</sub> : A, SW <sub>33</sub> : A, SW <sub>34</sub> : A, SW <sub>35</sub> : A, SW <sub>37</sub> : A, SW <sub>38</sub> : A, SW <sub>39</sub> : A, SW <sub>48</sub> : ON, SW <sub>49</sub> : ON, SW <sub>51</sub> : B, SW <sub>52</sub> : B, SW <sub>56</sub> : ON, BUS Data = power on reset
D <sub>1</sub>	Horizontal Oscillation Control Sensitivity	D	B	ON	OFF	A	ON	Calculate the pin 41 (H.out) frequency variation rate when the voltage on pin 45 is varied by $\pm 0.05\text{ V}$ with a horizontal oscillation frequency of 15.734 kHz.
D <sub>2</sub>	Horizontal Sync Phase	↑	C	↑	ON	↑	↑	<p>Measure the phase difference <math>S_{PH1}</math> of the pin 41 (H.out) waveform in relation to the pin 49 (HD.out) waveform when a 50 Hz composite video signal is applied to TP52. Measure the phase difference <math>S_{PH2}</math> of the pin 45 waveform in relation to the center of the input signal's horizontal sync signal. Also, apply a 60 Hz composite video signal to pin 52 and measure <math>S_{PH3}</math>.</p>

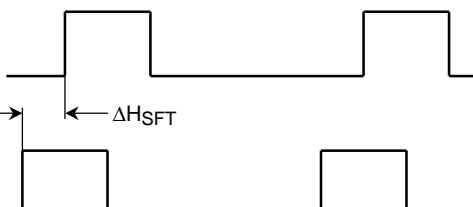
Note	Parameter	Test Conditions (unless otherwise stated, $V_{CC1} = 5\text{ V}$ , $V_{CC2}/V_{CC3}/DEF V_{CC} = 9\text{ V}$ , $T_a = 25 \pm 3^\circ\text{C}$ )						Test Conditions
		Switching Mode						
		SW <sub>16</sub>	SW <sub>17</sub>	SW <sub>18</sub>	SW <sub>20</sub>	SW <sub>23</sub>	SW <sub>25</sub>	
D <sub>3</sub>	Range of Curve Correction	D	C	ON	ON	A	ON	<p>Vary the voltage by 1.5 V to 3.5 V, apply a 50 Hz composite video signal to pin TP52, and measure the phase variation of the pin 41 (H.out) waveform.</p>  <p>Pin 49 Waveform</p>  <p>Pin 41 Input Signal</p> 
D <sub>4</sub>	Horizontal Screen Phase Adjustment Range	↑	↑	↑	↑	↑	↑	<p>Under the same conditions as those for D<sub>3</sub>, measure phase variation of the pin 41 (H.out) waveform when subaddress (0B) data D<sub>7</sub> to D<sub>3</sub> are varied by (00000) to (11111).</p> <p>Pin 49 Waveform</p>  <p>Pin 41 Input Signal</p> 

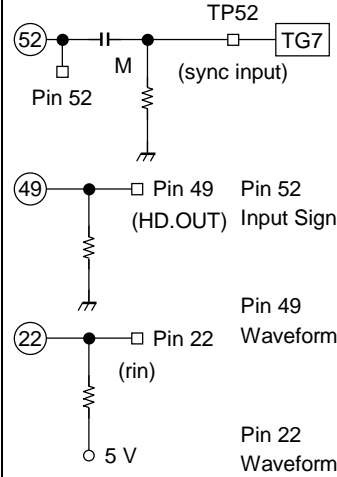
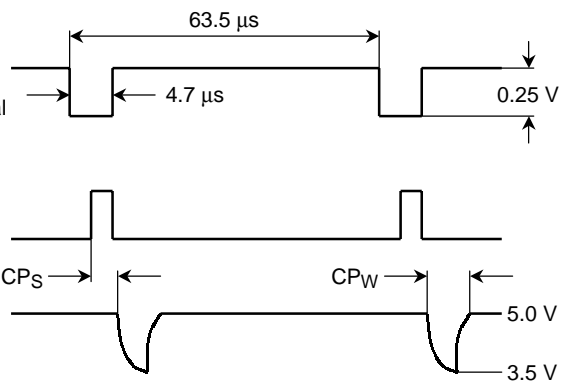
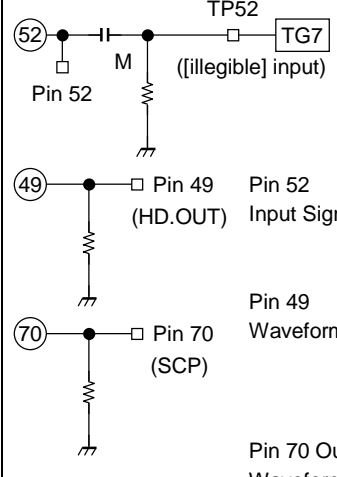
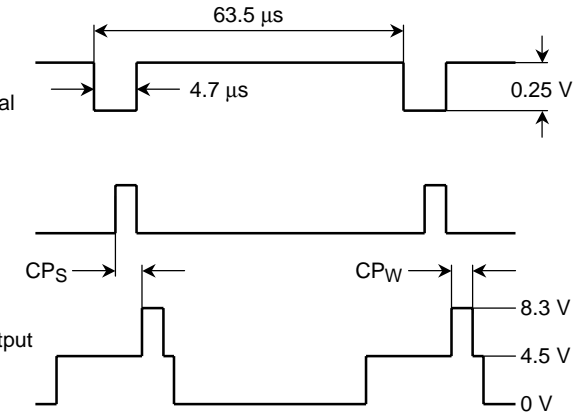
Note	Parameter	Test Conditions (unless otherwise stated, $V_{CC1} = 5\text{ V}$ , $V_{CC2}/V_{CC3}/DEF V_{CC} = 9\text{ V}$ , $T_a = 25 \pm 3^\circ\text{C}$ )							Test Conditions
		Switching Mode							
		SW <sub>16</sub>	SW <sub>17</sub>	SW <sub>18</sub>	SW <sub>20</sub>	SW <sub>23</sub>	SW <sub>25</sub>	SW <sub>35</sub>	
D <sub>5</sub>	Clamp Pulse Start Phase Pulse Width of Clamp Pulse	D	C	ON	ON	A	ON	OPEN	 <p>Apply a 50 Hz composite video signal to TP52, then measure the phase difference <math>CP_S</math> and the pulse width <math>CP_W</math> of the pin 22 (R in) waveform in relation to the pin 49 (HD.out) waveform.</p> 
D <sub>6</sub>	Gate Pulse Start Phase Pulse Width of Gate Pulse	↑	↑	↑	↑	↑	↑	—	 <p>Apply a 50 Hz composite video signal to TP52, then measure the phase difference <math>CP_S</math> and the pulse width <math>CP_W</math> of the pin 70 (SCP) waveform in relation to the pin 49 (HD.out) waveform.</p> 

Note	Parameter	Test Conditions (unless otherwise stated, $V_{CC1} = 5\text{ V}$ , $V_{CC2}/V_{CC3}/DEF V_{CC} = 9\text{ V}$ , $T_a = 25 \pm 3^\circ\text{C}$ )						Test Conditions
		Switching Mode						
		SW16	SW17	SW18	SW20	SW23	SW25	
D7	Horizontal Blanking Pulse Start Phase Pulse Width of Horizontal Blanking Pulse	D	C	ON	ON	A	ON	<p>Under the same conditions as those for D<sub>6</sub>, measure the phase difference HP<sub>S</sub> and HP<sub>W50</sub> of the horizontal blanking pulse. Also measure HP<sub>W60</sub> at 60 Hz.</p>
D8	HD Output Start Phase HD Output Pulse Width HD Output Amplitude	↑	↑	↑	↑	↑	↑	<p>Apply a 50 Hz composite video signal to TP52, then measure the phase difference HP<sub>S</sub> and the pulse width HP<sub>W</sub>/V<sub>HD</sub> of the pin 49 (HD out) waveform in relation to the pin 45 (AFC1 filter) waveform.</p>

Note	Parameter	Test Conditions (unless otherwise stated, $V_{CC1} = 5\text{ V}$ , $V_{CC2}/V_{CC3}/DEF\ V_{CC} = 9\text{ V}$ , $T_a = 25 \pm 3^\circ\text{C}$ )						Test Conditions
		Switching Mode						
		SW <sub>16</sub>	SW <sub>17</sub>	SW <sub>18</sub>	SW <sub>20</sub>	SW <sub>23</sub>	SW <sub>25</sub>	
D <sub>9</sub>	Vertical Blanking Pulse Start Phase (1)	D	C	ON	ON	A	ON	<p>Apply a 50 Hz composite video signal to TP52, then measure the phase difference <math>VP_{50S1}</math> and the pulse width <math>VP_{50S2}</math> of the pin 70 (SCP) waveform in relation to the pin 49 (sync input) waveform.</p>
	Vertical Blanking Pulse End Phase (1)							
D <sub>10</sub>	Vertical Blanking Pulse Start Phase (2) Vertical Blanking Pulse End Phase (2)	↑	↑	↑	↑	↑	↑	Apply the same conditions as those for D <sub>9</sub> except change the input signal to a 60 Hz comp. video signal and measure the phase difference $VP_{60S}$ and pulse width $VP_{60W}$ .
D <sub>11</sub>	Vertical Pull-In Range (1)	↑	↑	↑	↑	↑	↑	Input a 50 Hz composite video signal to pin TP52, vary the vertical frequency of this signal in 0.5H-steps, and measure the vertical pull-in range.
	Vertical Pull-In Range (2)							Set D <sub>5</sub> to D <sub>3</sub> of subaddress (17) to (001), vary the vertical frequency of a 60 Hz composite video signal input to pin TP52 in 0.5H-steps, and measure the vertical pull-in range.
	Vertical Pull-In Range (3)							Input a 50 Hz composite video signal to pin TP52, vary the vertical frequency of this signal in 0.5H-steps, and measure the number of Hs when D <sub>2</sub> of the 1 <sup>st</sup> byte changes from 0 to 1 in bus read mode. Also check that D <sub>1</sub> of the 1 <sup>st</sup> byte is 0 when $1\text{ V} = 312.5\text{H}$ , when D <sub>1</sub> is 1 in bus read mode, and $1\text{ V} < 311.5$ or $1\text{ V} > 313.5\text{H}$ .
	Vertical Pull-In Range (4)							Input a 60 Hz composite video signal to pin TP52, vary the vertical frequency of this signal in 0.5H-steps, and measure the number of Hs when D <sub>2</sub> of the 1 <sup>st</sup> byte changes from 1 to 0 in bus read mode when. Also check that D <sub>1</sub> of the 1 <sup>st</sup> byte is 0 when $1\text{ V} = 262.5\text{H}$ , D <sub>1</sub> is 1 in bus read mode, and $1\text{ V} < 261.5$ or $1\text{ V} > 263.5\text{H}$ .

Note	Parameter	Test Conditions (unless otherwise stated, $V_{CC1} = 5\text{ V}$ , $V_{CC2}/V_{CC3}/DEF V_{CC} = 9\text{ V}$ , $T_a = 25 \pm 3^\circ\text{C}$ )								
		Switching Mode								Test Conditions
		SW <sub>16</sub>	SW <sub>17</sub>	SW <sub>18</sub>	SW <sub>20</sub>	SW <sub>23</sub>	SW <sub>25</sub>	SW <sub>33</sub> SW <sub>34</sub> SW <sub>35</sub> SW <sub>37</sub> SW <sub>38</sub> SW <sub>39</sub>	#6 #21 #27	
D <sub>12</sub>	RGB Output Vertical Blanking Pulse Start Phase (1)  RGB Output Vertical Blanking Pulse End Phase (1)	D	C	ON	ON	A	ON	A	Ground	<p>Apply a 50 Hz composite video signal to TP52, then measure the phase difference <math>VR_{50S1}</math> and the pulse width <math>VR_{50S2}</math> of the pin 11 (R.out) waveform in relation to the pin 52 (sync input) waveform. Similarly, measure pins 13 and 15.</p>
D <sub>13</sub>	RGB Output Vertical Blanking Pulse Start Phase (2)  RGB Output Vertical Blanking Pulse End Phase (2)	↑	↑	↑	↑	↑	↑	↑	↑	Apply the same conditions as those for D <sub>12</sub> except change the input signal to a 60 Hz comp. video signal and measure the phase difference $VP_{60S1}$ and pulse width $VP_{60S2}$ .

**Chroma Test Signals**

**Text/Color Difference Test Signals**

1) **Input Signal C-1**

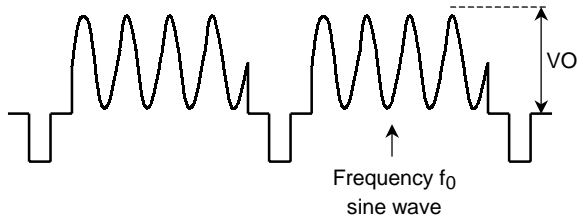

1) **Video Signal**

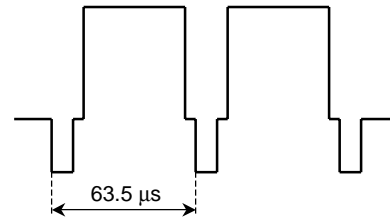

2) **Input Signal C-2**

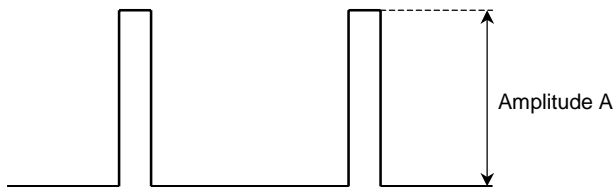

2) **Input Signal 1**

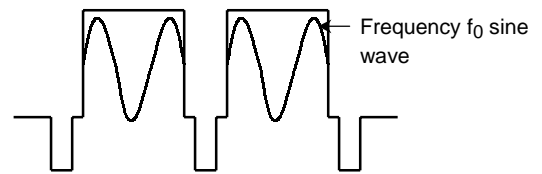

3) **Input Signal C-3**

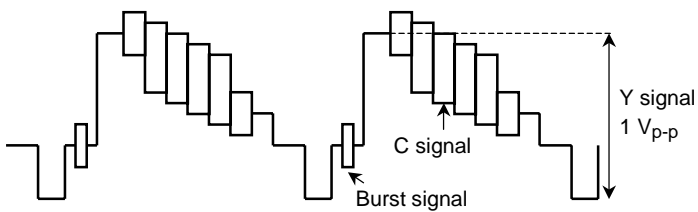

3) **Input Signal 2**

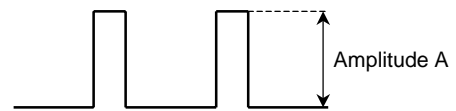

4) **Input Signal C-4**

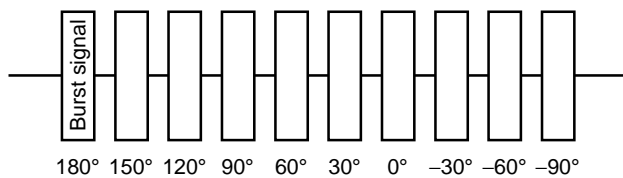

4) **Input Signal 3**

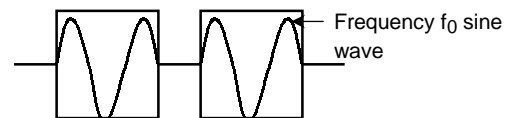



**Vertical Output Pulse Width/Vertical Output Pulse Phase Variation/Vertical Output Pulse Phase Range**

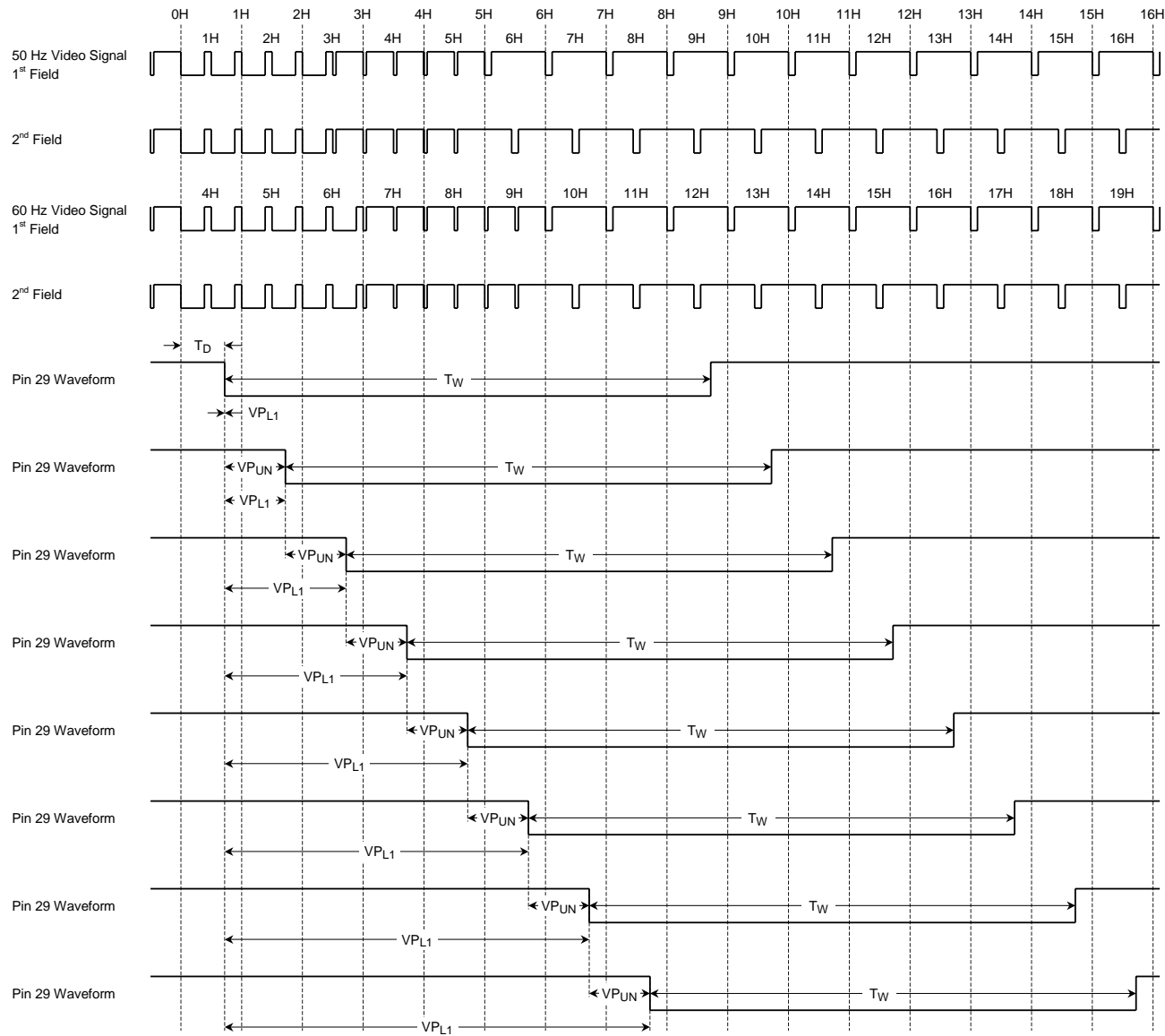

**RGB Vertical Blanking Pulse Start Phase/End Phase**

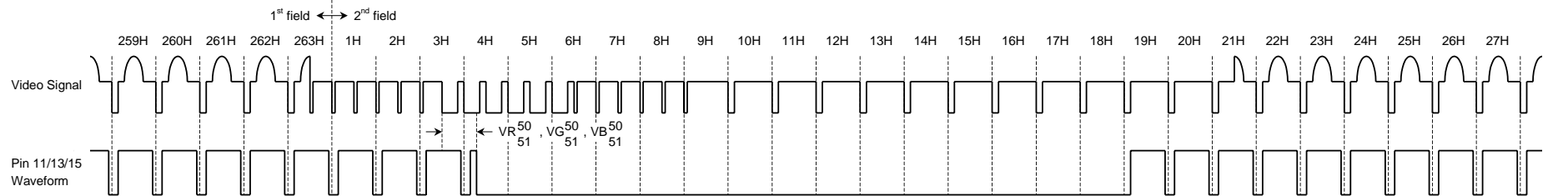
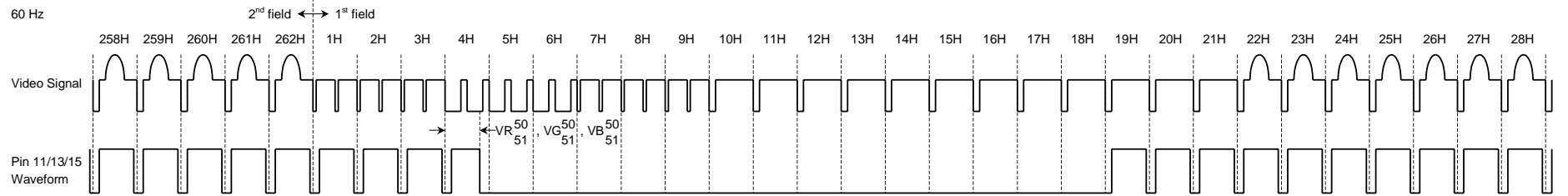
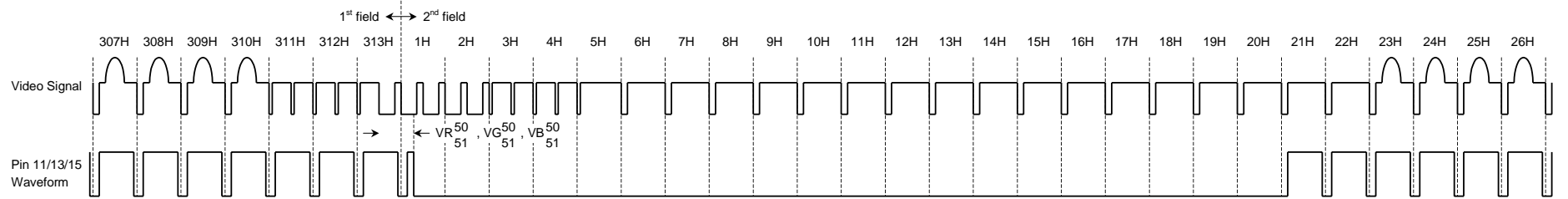
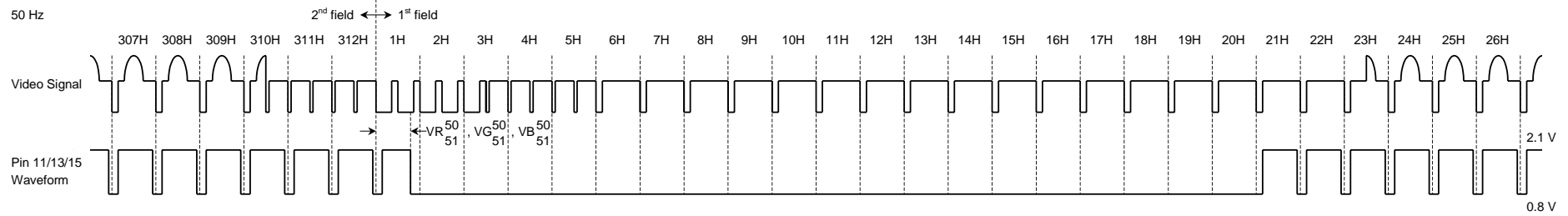

Test Circuit

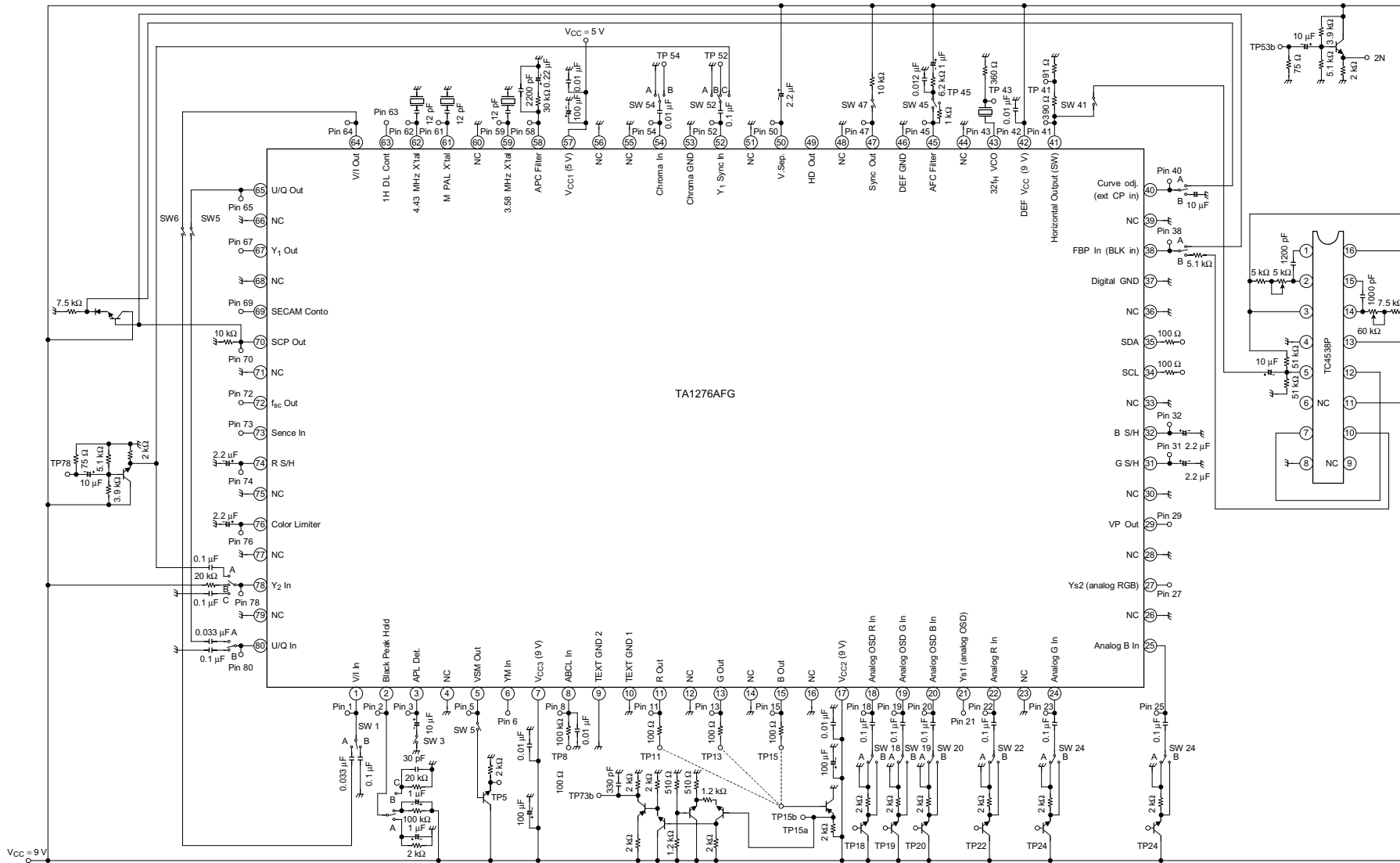



Application Circuit 2-Normal Scan (4.43 PAL/4.43 NTSC/3.58 NTSC)

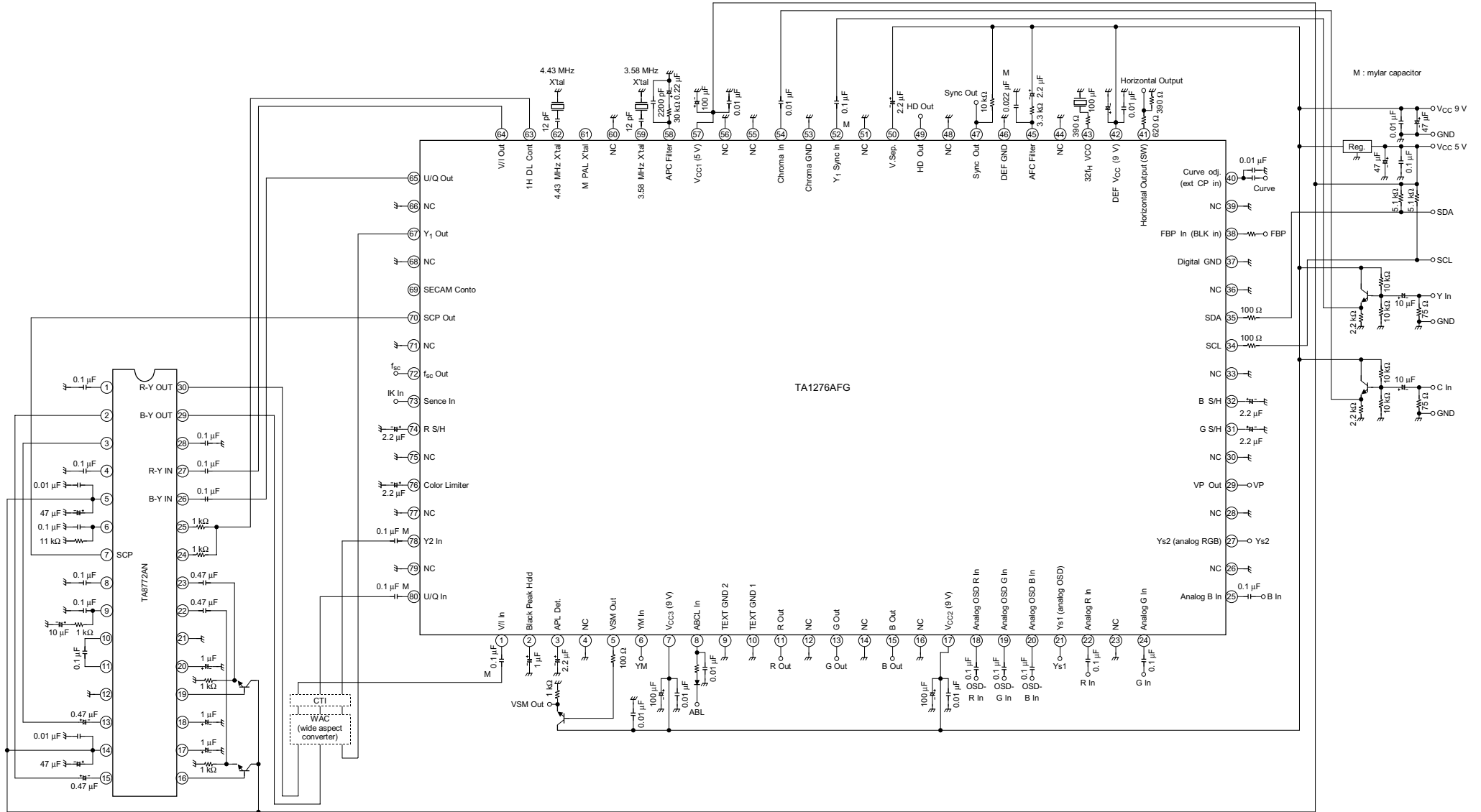





Application Circuit 5-Double Scan (3.58 NTSC)

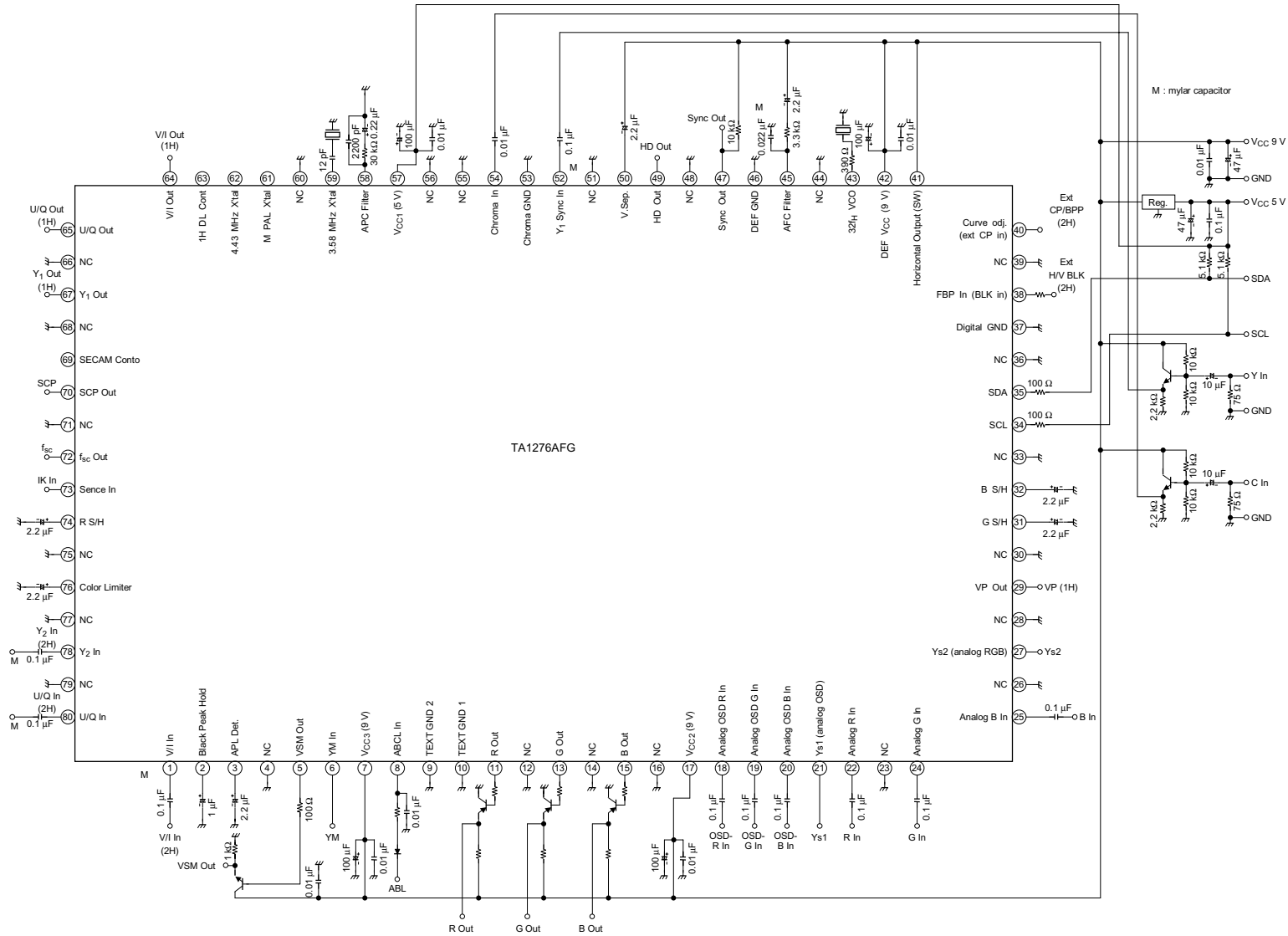



## AKB Application Circuit

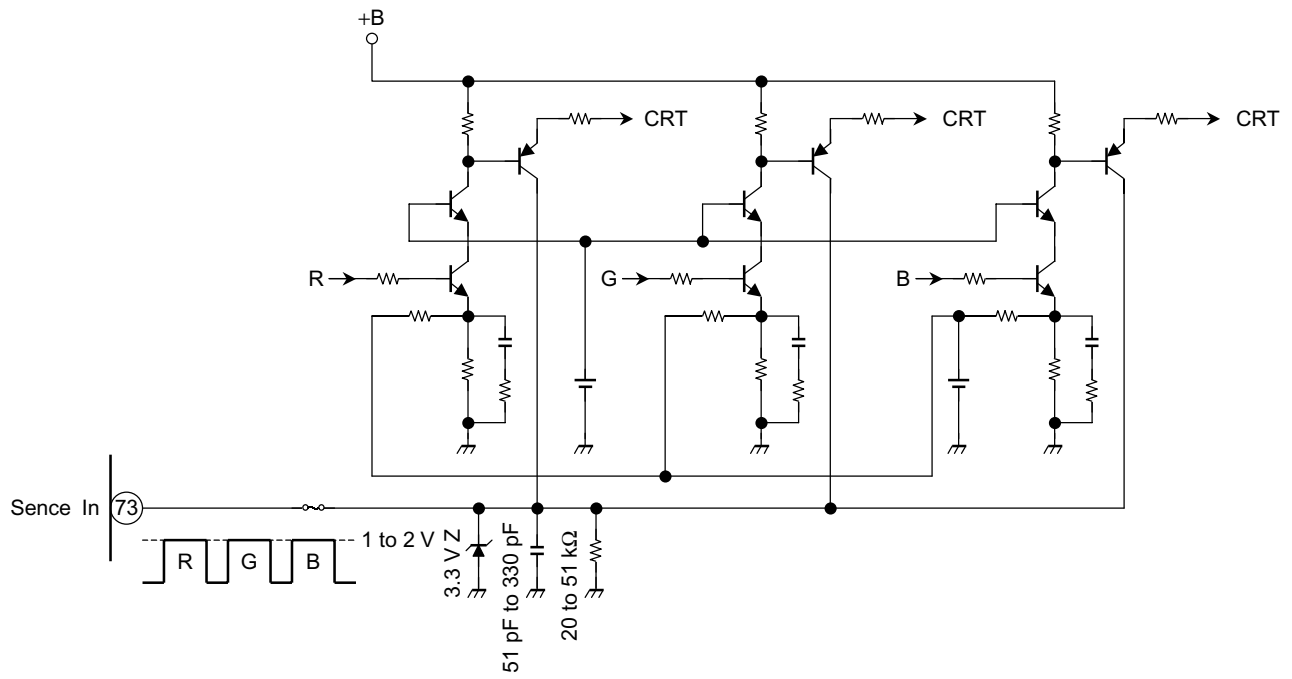

## Package Dimensions

QFP80-P-1420-0.80F

Unit: mm

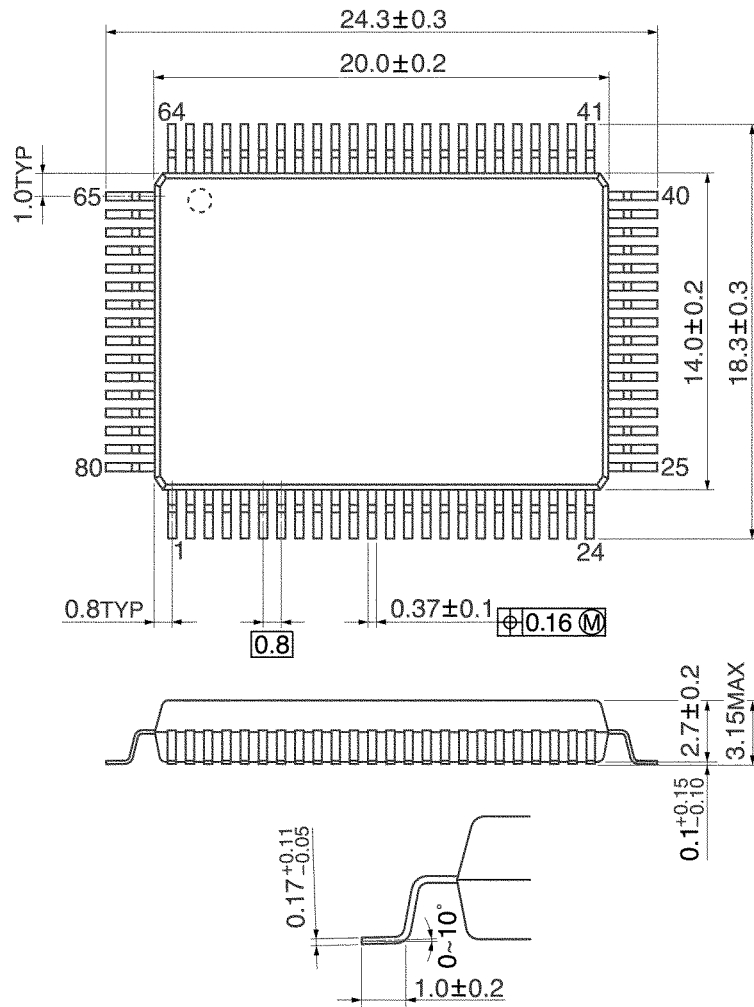

Weight: 1.6 g (typ.)

**RESTRICTIONS ON PRODUCT USE**

000707EBA

- TOSHIBA is continually working to improve the quality and reliability of its products. Nevertheless, semiconductor devices in general can malfunction or fail due to their inherent electrical sensitivity and vulnerability to physical stress. It is the responsibility of the buyer, when utilizing TOSHIBA products, to comply with the standards of safety in making a safe design for the entire system, and to avoid situations in which a malfunction or failure of such TOSHIBA products could cause loss of human life, bodily injury or damage to property.  
In developing your designs, please ensure that TOSHIBA products are used within specified operating ranges as set forth in the most recent TOSHIBA products specifications. Also, please keep in mind the precautions and conditions set forth in the "Handling Guide for Semiconductor Devices," or "TOSHIBA Semiconductor Reliability Handbook" etc..
- The TOSHIBA products listed in this document are intended for usage in general electronics applications (computer, personal equipment, office equipment, measuring equipment, industrial robotics, domestic appliances, etc.). These TOSHIBA products are neither intended nor warranted for usage in equipment that requires extraordinarily high quality and/or reliability or a malfunction or failure of which may cause loss of human life or bodily injury ("Unintended Usage"). Unintended Usage include atomic energy control instruments, airplane or spaceship instruments, transportation instruments, traffic signal instruments, combustion control instruments, medical instruments, all types of safety devices, etc.. Unintended Usage of TOSHIBA products listed in this document shall be made at the customer's own risk.
- The products described in this document are subject to the foreign exchange and foreign trade laws.
- The information contained herein is presented only as a guide for the applications of our products. No responsibility is assumed by TOSHIBA CORPORATION for any infringements of intellectual property or other rights of the third parties which may result from its use. No license is granted by implication or otherwise under any intellectual property or other rights of TOSHIBA CORPORATION or others.
- The information contained herein is subject to change without notice.